

**ANTES DE COMENZAR, RECOPILE TODO EL MATERIAL DE APOYO PARA EL MONTAJE:** Instrucciones de montaje / ilustraciones paso a paso / planos y plantillas impresos a escala.

**PREPARACIÓN DEL MATERIAL:** Para poder identificar correctamente las piezas precortadas, antes de extraerlas de las planchas de madera, marque en ellas la misma numeración que aparece en la hoja "IP" (identificación de piezas), incluida en las instrucciones.

**INICIO DEL MONTAJE:** Con la ayuda de un cúter y procurando no colocar los dedos en la línea de corte, desprenda las piezas de las planchas eliminando los pequeños nervios que las sujetan. Seguidamente lije con suavidad las piezas con papel de lija de grano fino, para eliminar el repelo de las mismas. El orden numérico del paso a paso indica el orden de elaboración y colocación de las piezas. Es importante comprobar el ajuste de las piezas antes de pegarlas definitivamente.

**LISTONES Y VARILLAS:** Los modelos incorporan varios tipos de listones y varillas para elaborar las diferentes piezas. La lista de piezas proporciona información sobre el tipo de material y medidas. En algunos casos es conveniente ajustar las medidas sobre el propio modelo, conforme avanzamos en el montaje. De esta manera se consigue un mejor ajuste.

**PEGAMENTOS RECOMENDADOS:** Cola blanca o de carpintero. Para las uniones de piezas de madera y de todas aquellas piezas que no ofrezcan resistencia.

Pegamento rápido. Para piezas que sean difíciles de sostener y que necesiten un secado casi instantáneo.

Cola de contacto o de zapatero. Para todas aquellas piezas que se forren con chapas finas de madera o metal. En todos los casos, lea siempre las instrucciones de uso del fabricante.

**SERVICIO DE ATENCIÓN AL CLIENTE:** Para cualquier duda o información sobre el montaje de nuestros productos, puede contactar con nuestro Servicio Técnico en la dirección:

[www.occre.com](http://www.occre.com). Le atenderemos con mucho gusto.

**BEFORE STARTING, MAKE SURE YOU HAVE ALL THE SUPPORT MATERIAL FOR ASSEMBLING THE MODEL:**

Assembly Instructions / Step by step pictures / Plans and templates printed to scale.

**PREPARING THE MATERIAL:** In order to correctly identify the precut parts, before removing them from the wooden sheets, mark on them the same numbers that appear on the "IP"

(Part Identification) Sheet included with the instructions.

**STARTING THE ASSEMBLY:** Using a cutter, and making sure you do not put your fingers along the cutting line, remove the parts from the wooden sheets, eliminating the small sprues that hold them in place. In continuation smoothly sand down the parts, using fine grain sandpaper, to eliminate the pickup of the parts. The numerical order indicates the order in which the different parts must be made up and fitted.

**STRIPS AND RODS:** These models incorporate a variety of different types of strips and rods with which to make up the different parts of the kit. The list of parts proportions information on the type of material and measurements. In some cases it is advisable to adjust the measurements on the basis of the model itself, as assembly progresses. In this way you will achieve a better fit.

**RECOMMENDED GLUES:** White, or carpenter's glue: For joining pieces of wood together. Mainly used for gluing together the skeleton. Quick-drying glue. For parts that are difficult to hold in their final position and which need to set instantly. Recommended for fitting small parts. Contact or cobbler's glue. For gluing into place the parts that are covered with fine wood veneer to set instantly. In all cases, always follow the manufacturer's recommendations.

**CUSTOMER ATTENTION SERVICE:** In the case of whatsoever doubt or further information that you may require regarding the assembly of our products, please contact our Technical Service online at the address: [www.occre.com](http://www.occre.com). We will be delighted to attend to you.

**AVANT DE COMMENCER, VÉRIFIEZ TOUT LE MATÉRIEL DE SOUTIEN POUR LE MONTAGE:**

**PRÉPARATION DU MATÉRIEL:** Pour pouvoir identifier correctement les pièces prédécoupées, avant de les extraire des planches de bois, inscrivez sur elles la même numérotation qui apparaît sur la page « IP » (identification des pièces) comprise dans les instructions.

**DÉBUT DU MONTAGE:** À l'aide d'un cutter, et en essayant de ne pas poser les doigts sur la ligne de découpe, séparez les pièces des planches en éliminant les petits nerfs qui les retiennent. Puis poncez doucement les pièces à l'aide d'un papier de verre à grain fin, pour éliminer le contrefil. L'ordre numérique des étapes photographiques et des plans indique l'ordre d'élaboration et d'installation des pièces.

**LISTEAUX ET BAGUETTES:** Les modèles intègrent plusieurs types de listeaux et de baguettes destinés à confectionner les différentes pièces. La liste des pièces indique le type de matériau et les dimensions des pièces. Il est parfois recommandé d'ajuster les mesures sur le modèle lui-même, au fur et à mesure que nous avançons dans le montage. De cette manière, on obtient un meilleur réglage.

**COLLES RECOMMANDÉES:** Colle blanche ou de menuisier: Pour les unions de pièces en bois et de toutes les pièces qui n'offrent pas de résistance. Colle à séchage rapide: Pour les pièces qui sont difficiles à maintenir dans leur position et qui requièrent un séchage pratiquement instantané. Colle de contact ou de cordonnier: Pour toutes les pièces qui sont recouvertes de fines plaques de bois ou de métal. Dans tous les cas, lisez toujours les instructions d'utilisation du fabriquant.

**SERVICE CLIENT:** Pour toute question ou information concernant le montage de nos produits, vous pouvez contacter notre Service Technique à l'adresse suivante: [www.occre.com](http://www.occre.com).

Nous répondrons avec plaisir à vos questions.

**PRIMA D'INIZIARE, RIUNIRE TUTTO IL MATERIALE D'APPOGGIO PER IL MONTAGGIO:** Istruzioni di montaggio, immagini passo per passo, planimetrie e modelli stampati in scala.

**PREPARAZIONE DEL MATERIALE:** Per poter identificare in maniera corretta i pezzi che sono stati ritagliati, prima di estrarli dai blister di legno occorre segnarli con la stessa numerazione che è indicata nella pagina "IP" (Identificazione pezzi) che si trova nelle istruzioni.

**INIZIO DEL MONTAGGIO:** Con l'aiuto di un cutter, ed evitando di collocare le dita lungo la linea di taglio, separare i pezzi dai blister eliminando i piccoli nervi che li mantengono attaccati.

In seguito, scartavetrare con delicatezza i pezzi, utilizzando una carta vetrata a grana fine, onde eliminare le sbavature degli stess. L'ordine numerico del passo per passo indica l'ordine d'elaborazione e di collocazione dei pezzi. È importante verificare che questi combacino bene, prima d'incollarli definitivamente.

**ASTE E BACCHETTE:** I modelli sono dotati di vari tipi di aste e bacchette per formare i diversi pezzi. L'elenco dei pezzi offre informazioni sul tipo di materiale e sulle misure. In alcuni casi è conveniente modificarne le misure quando sono sul modello, man mano che si avanza nel montaggio. In questo modo si potrà ottenere che combacino meglio.

**COLLE RACCOMANDATE:** Colla bianca o da falegname: Per unire tra loro i pezzi in legno e tutti quei pezzi che non presentino resistenza. Colla rapida: Per i pezzi difficili da sostenere e per i quali sia necessaria un'asciugatura quasi istantanea. Colla a contatto o da calzolaio: Per tutti quei pezzi che vengono rivestiti con fine lastre di legno o di metallo. In ogni caso, leggere sempre le istruzioni d'uso del produttore.

**SERVIZIO ASSISTENZA CLIENTE:** Per qualsiasi dubbio o informazione sul montaggio dei nostri prodotti, contattare il nostro Servizio Tecnico al seguente indirizzo: [www.occre.com](http://www.occre.com).

Seremo lieti di potervi aiutare.

**BEVOR SIE MIT DEM ZUSAMMENBAU BEGINNEN, LEGEN SIE SICH BITTE ALLE HILFSMATERIALIEN FÜR DIE MONTAGE BEREIT:**

Bastelanleitung / Maßstabgerechte Skizzen und Schablonen / Skizzen und Vorlagen.

**VORBEREITUNG DER MATERIALIEN:** Damit die einzelnen Bauteile korrekt zugeordnet werden können, empfehlen wir, auf den Holzplättchen vor dem Herausnehmen mit einem Bleistift die Nummer auf dem Blatt IP (Identifikation Teile) zu markieren.

**BEGINN DES ZUSAMMENBAUS:** Die Teile mit einem Schneidwerkzeug (Cutter) herauslösen und die kleinen Befestigungsenden entfernen. Dabei darauf achten, die Finger nicht zu verletzen. Danach die Teile vorsichtig mit feinem Schmirgelpapier säubern, um ausgefranste Ränder zu entfernen. Die Nummernfolge der Schritte auf Fotos und Skizzen gibt an, in welcher Reihenfolge die Teile zusammengebaut werden.

**LEISTEN UND STÄBE:** Die Modelle enthalten mehrere Arten von Leisten und Stäben, aus denen die einzelnen Teile des Bausatzes geformt werden. In einigen Fällen kann es angebracht sein, die Maße im Zuge des Zusammenbaus entsprechend dem Modell anzupassen. Auf diese Weise wird eine bessere Passform erricht.

**EMPFOHLENE KLEBSTOFFE:** Weißleim (Tischlerleim): Zum Kleben von Strukturteilen und allen nachgiebigen Teilen. Sekundenkleber: Für schwer zu haltende Teile, die schnell verklebt werden müssen. Kontaktkleber (Schusterleim): Für alle Teile, die mit dünnen Holz- oder Metallstücken zum Beplanken oder Verkleiden beklebt werden. Bitte beachten Sie stets die Hinweise des Herstellers.

**UNSER KUNDENDIENST:** Bei Fragen zum Aufbau unserer Modelle steht Ihnen unser Kundendienst zur Verfügung. Sie erreichen uns online unter: [www.occre.com](http://www.occre.com).

Wir stehen Ihnen gern mit Rat und Tipps zur Verfügung.

**A.** Utilice una superficie plana y estable para pegar las piezas A1 y A2, y refuerce su unión con las piezas A3. Siguiendo el orden alfanumérico inserte y pegue las piezas indicadas en las figuras. Antes de encolar las cuadernas, verifique que encajan correctamente en su posición haciendo “tope” en los encajes correspondientes de la falsa quilla. Es importante que las cuadernas queden completamente perpendiculares a la falsa quilla para que posteriormente encajen bien las cubiertas. Para esta operación utilice como adhesivo cola blanca, (Ref. 19200).

**B y C.** Utilice las cubiertas para alinear y pegar las piezas de las estructuras que muestran las imágenes. Para esta operación utilice cola blanca, (Ref. 19200). Después, retire las estructuras de las cubiertas y aplique masilla tapa-grietas para tapar las uniones. Cuando la masilla se haya secado, lije los conjuntos para unificar sus superficies. Si no dispone de una lima plana, puede construir una pegando un papel de lija sobre una porción de listón. Después, aplique pintura de color blanco, (Ref.19300). Puede aplicar la pintura a pincel o con aerógrafo, siendo éste último con el que obtendrá un acabado óptimo.

**D.** Trace una línea longitudinal que divida la cubierta B1 en dos mitades. Comience a forrar ajustando la primera chapa a la línea de lápiz. Pegue las chapas muy juntas para que no se noten las uniones. Utilice como adhesivo cola blanca, (Ref.19200). Presione las chapas contra la cubierta para que se adhieran con firmeza. Es aconsejable, colocar algún objeto pesado y plano encima hasta que la cola se seque. Después, coloque la cubierta bocabajo y corte los sobrantes de las chapas con un cúter. Lije la cubierta hasta dejar su superficie fina y homogénea. Después, elimine el polvo resultante del lijado y aplique un par de capas de barniz satinado, (Ref. 19209), lijando entre una y otra. Proceda de la misma manera con las cubiertas B9, B16 y D2. Presente las cubiertas C1, C10 y C22 sobre una superficie plana. Sitúe las estructuras que ya tiene construidas para comprobar su ajuste. Después, pegue las tres cubiertas entre si y retire las estructuras. Lije y forre la cubierta obtenida con las chapas D3. Después, lije y barnice la cubierta.

**E y F.** Aplique cola blanca, (Ref.19200), y pegue las estructuras sobre las cubiertas de forma definitiva. Utilice un lijador plano para igualar la parte superior de las estructuras. Utilice un cúter para sacar las decoraciones de la hoja que las agrupa. Coloque las decoraciones siguiendo las indicaciones de las fotos. Estas decoraciones son autoadhesivas y vienen ya recortadas. Utilice un listón plano o un bastoncillo de algodón para presionarlas y que se fijen con firmeza. Presente las cubiertas sobre el esqueleto para comprobar su ajuste. Después, péguelas cómo le indican las imágenes.

**G.** Coloque el casco boca abajo y comience a lijar empezando desde proa y avanzando hacia popa. Debe desbastar las aristas de las cuadernas pero sin deformar su forma original. El lijado del casco ha de quedar simétrico, es decir, que el lateral derecho ha de quedar igual que el izquierdo. Para la zona media del casco, utilice un taco lijador con mayor superficie. El lijado debe ser progresivo y suave. Compruebe con un listón, que el lijado es correcto. Para ello, debe deslizar el listón, sobre las cuadernas, para ver como se ajusta a su forma.

**H.** Lije las piezas H1 y H2 con papel de lija fino. Después, sumérgalas en agua durante unos 20 minutos. Utilice algún objeto cilíndrico para curvar poco a poco las piezas. Debe presionar la pieza colocando los dedos muy juntos para evitar que se rompa. Utilice cinta de pintor para aislar las zonas de las piezas y píntelas de color blanco, (Ref. 19300). Después, coloque y pegue las piezas en el casco con pegamento rápido.

**I a K.** Comience el forrado del casco con los listones i1. Si los listones estuvieran muy secos y se le rompen al curvarlos, sumérgalos en agua unos veinte minutos. Con esta operación, recuperarán flexibilidad. Después, séquelos con un paño. Debe ajustar la longitud del primer listón y pegarlo con cola blanca, (Ref. 19200), entre las piezas H1 y H2.. Observe las imágenes siguientes antes de proceder. Los demás listones del forro debe pegarlos a las cuadernas y entre sí, con cola blanca y fijarlos con puntas. Continúe pegando listones desde proa hasta popa para forrar el casco entero. Deberá cortar a medida y ajustar las piezas para que encajen en los huecos. Si en algún punto le ha quedado algún listón suelto, puede aplicar pegamento de secado rápido. Si le ha quedado algún listón más hundido, pegue otro encima y después, líjelo. Lime las cabezas de las puntas con una lima plana hasta que queden enrasadas con el forro. Pegue los refuerzos K2 a K5 en la zona de popa del casco. Diluya un poco de cola blanca con agua para que pueda aplicarla ligeramente y se filtre entre las juntas de los listones. Reserve el casco hasta que la cola se seque. Con esta operación se unificará el forro del casco ganando así consistencia. Después, lije todo el casco. Debe quedar suave y sin desniveles.

**L.** Aplique una capa de masilla tapa grietas a toda la superficie del forro del casco. Cuando se seque, líjelo todo para dejarlo fino y sin desniveles. Lije y pinte las piezas L1 a L4 de color blanco, (Ref.19300). Ajuste y pegue las piezas L1 y L2 con pegamento de secado rápido. Proceda de la misma manera para pegar las piezas L3 y L4 en el otro lado del barco. Corte a medida y pegue las piezas L5 a L7 y lije para suavizarlas.

**M y N.** Utilice cinta de carroceros para enmascarar las zonas de la estructura del casco y dejar descubierto el forro. Aplique una imprimación a toda la superficie. Es recomendable utilizar spray, y a ser posible de color gris. Ésta permitirá ver los posibles defectos del forro. Después de aplicar el producto, lije el casco de nuevo. Corrija las imperfecciones con masilla y repita el proceso hasta dejar un casco fino. Aplique pegamento rápido y pegue las piezas M1 a M34. Utilice la plantilla PL-01 para identificar las piezas y su posición en el casco. Utilice como separador la pieza M35. Esta pieza le servirá para mantener las piezas paralelas entre si. Después, vuelva a enmascarar el casco y aplique imprimación, con esta operación, las piezas M1 a M34, sacarán un repelo que debe volver a lijar. Utilice papel de lija o esponja-lija de grano fino. Pegue las piezas N1 a N9. Para esta operación utilice cola blanca, (Ref. 19200) y pinzas.

**O a R.** Elabore y añada al casco las piezas que le indican las imágenes. Enmascare la parte superior del barco para reservarlo de la pintura. Pinte el casco con pintura de color negro, (Ref. 19301), y resérvelo hasta que se seque. Para hallar la línea de flotación, sitúe el casco sobre una superficie plana e inmovilícelo. Utilice un lápiz y un taco de madera o similar para marcar la línea a todo el perímetro del casco. Enmascare de nuevo y pinte de color marrón rojizo, (Ref. 19383). Elabore y pinte la pieza O2 con los mismos colores del casco. Pinte las hélices de color oro, (Ref. 19380). Pegue las piezas O2 a O5 en el casco. Continúe añadiendo piezas al barco, algunas deberá colocarlas ya pintadas. Pinte las piezas Q5 de color ocre y péguelas al barco. Para conseguir el color ocre, mezcle los colores amarillo, (Ref. 19306), con unas gotas de marrón, (Ref. 19307), y marrón, (Ref. 19383). Algunas piezas deberá pintarlas de color negro, (Ref. 19301), y destacar sus relieves con pintura de color plata, (Ref. 19382).

**S a W.** Forre las cubiertas de la superestructura, líjelas y barnícelas. Construya las estructuras y aplíqueles masilla para tapar las uniones. Después, píntelas de color blanco, (Ref. 19300), y gris, (Ref. 19302), cómo muestran las imágenes. Añada las piezas y decoraciones siguiendo las indicaciones de las fotos y la plantilla PL-01. Construya las cuatro chimeneas encajando y pegando las piezas correspondientes. Observe que hay tres medidas diferentes de chimenea. Píntelas de color negro, (Ref. 19301), y color ocre.

**X a Z.** Pinte las piezas X21 y X22 de color verde, (Ref.19314), y negro (Ref. 19301), y oscurezcalas con pintura marrón, (Ref. 19307). Las piezas X23 deberá pintarlas de color marrón, (Ref. 19307). Las piezas Y25 deberá pintarlas de color blanco, (Ref. 19300), y color amarillo, (Ref. 19306). Las piezas Y21 y Z5 deberá pintarlas de color blanco, (Ref. 19300), y rojo, (Ref. 19310). Para elaborar las piezas Z58, Z59 y Z60, coloque tres piezas Z57 sobre una cinta de carroceros. Recorte y pegue encima las figuras de la plantilla y corte las chapas con la forma indicada. Después, añada las piezas B, y pinte de color ocre. Complete el barco añadiendo las piezas que le indican las imágenes.

## ARBOLADURA

Para elaborar los mástiles, el primer paso a seguir será cortar las varillas según las medidas que indica la lista de piezas, o bien tomarlas directamente de los planos que están impresos a escala 1/1.

Todos los mástiles y vergas tienen cierta conicidad que se deberá realizar.

Para realizar la conicidad a los mástiles, lije las varillas, (con un lijador), aumentando el desgaste de ésta a medida que se acerca al extremo donde se quiere disminuir el diámetro. Haga rodar la varilla para que el desgaste sea igual por todo el contorno hasta conseguir llegar al diámetro que indica el plano. Para elaborar la conicidad de las vergas, realice las mismas operaciones, pero esta vez a ambos extremos de la varilla. Deberá teñir o pintar las varillas en función del modelo que esté construyendo.

Para realizar correctamente los mástiles de este modelo se deberá tener en cuenta:

- Los planos
- Las fotos de detalle de los mástiles
- Las medidas y descripción de materiales de la lista de piezas
- Las hojas “IP” de identificación de piezas
- La plantilla PL-01

Los mástiles se deberán barnizar y algunas de las piezas que los componen se deberán pintar. Véanse las fotos generales de detalle de los mástiles. Una vez montados y barnizados, deberán colocarles los aparejos, (estrobos, cuadernales, cáncamos, motones, etc.), y fijarlos al barco. Los mástiles se deben introducir hasta hacer tope en los encajes de la falsa quilla.

## JARCIA

Para elaborar la jarcia de este barco, siga el orden alfabético de las figuras impresas de los planos, que indican el orden de colocación: de hilos, vigotas, motones, velas, etc, destacados en color rojo. La lista de piezas le orientara sobre el tipo de materiales y medidas a utilizar.

Para simular el envejecido de las velas, se les puede dar un baño con infusión de té, sin hacerlas hervir, y dejarlas secar bien arrugadas. Se colocaran sin planchar para que tengan cuerpo.

**A.** On a flat, stable surface glue pieces A1 and A2 together and strengthen their bond using pieces A3. Following the alphabetical and numerical order, insert and glue the pieces shown in the illustrations. Before gluing the frames, check that they fit correctly by inserting them into the corresponding sockets of the false keel. The frames must be completely perpendicular to the false keel so that the decks fit properly later. For this operation use white glue (Ref.19200), as an adhesive.

**B and C.** Use the decks to align and glue the frame pieces shown in the images. For this operation use white glue, (Ref. 19200). Next, remove the roof frames and apply filler to the joints. When the filler has dried, sand the assemblies to even their surfaces. If you don't have a flat file, you can build one by gluing sandpaper over a piece of the slat. Then apply white paint Anschließend weiß lackieren, (Ref.19300). You can apply the paint with a brush or with an airbrush, the latter will give the best finish.

**D.** Draw a longitudinal line dividing deck B1 into two halves. Begin by fitting the first veneer flush to the pencil line. Glue the plates closely together so that the seams are not noticeable. Use white glue (Ref.19200), as an adhesive. Press the plates against the deck so that they adhere firmly. It is advisable to place a flat, heavy object on top until the glue dries. Then turn the deck upside down and cut off the excess with a utility knife. Sand the deck down to a fine, smooth surface. Then remove any dust from sanding and apply a couple of coats of satin varnish, (Ref. 19209), sanding each time. Proceed in the same way with covers B9, B16 and D2. Lay out Covers C1, C10 and C22 on a flat surface. Position the structures you already have built to check their fit. Next, glue the three decks together and remove the structures. Sand and line the surface obtained with the D3 sheets. Then sand and varnish the deck.

**E and F.** Apply white glue, (Ref. 19200), and glue the structures on the roofs. Use a flat sander to even out the tops of the frames. Use a utility knife to remove the decorations from the sheet holding them. Place the decorations as shown in the photographs. These decorations are self-adhesive and come pre-cut. Use a flat ribbon or cotton swab to press them firmly into place. Offer up the decks over the frame to check their fit. Then glue them as illustrated.

**G.** Turn the hull upside down and begin sanding starting from bow to stern. You must rough the edges of the frames but without deforming their original shape. The hull must be sanded evenly; that is, the port and starboard side must be identical. For the middle of the hull, use a sanding block with a larger surface. Sanding must be progressive and smooth. Use a strip of wood to check that the sanding is correct. To do so, you must slide it over the frames, to see how it fits to the shape.

**H.** Sand pieces H1 and H2 with fine sandpaper. Then soak them in water for about 20 minutes. Use a cylindrical object to bend the pieces little by little. You must press the part with your fingers close together to prevent it from breaking. Use painter's tape to mask the parts and paint them white, (Ref. 19300). Then place and glue the pieces to the hull using instant glue.

**I to K.** Begin the hull lining using the i1 slats. If the slats are very dry and break when bending, soak them in water for about twenty minutes. This will make them flexible. Then dry them with a cloth. You must adjust the length of the first strip and glue it with white glue between pieces H1 and H2. Look at the illustrations before proceeding. The other hull strakes must be glued to the frames and to each other using white glue, (Ref. 19200), and nailed in place. Continue gluing strakes from bow to stern to line the entire hull. You will need to cut to size and adjust the pieces to fit the gaps. If at any point you have a loose strake, you can apply quick-drying glue. If a strake is below the plane of the others, stick another one on top and then sand it. File the nail heads off with a flat file until they are flush with the strakes. Glue the reinforcements K2 to K5 in the aft area of the hull. Dilute a little white glue with water to make it runnier and can seep between the slat joints. Set aside the hull until the glue dries. This will bind the whole hull together and the skin of the hull will be unified, thus gaining strength. Then sand the entire hull. It should be smooth and even.

**L.** Apply a coat of crack-filling putty to the entire surface of the hull shell plating. Once dry, sand it all down to make it smooth and even. Sand and paint pieces L1 to L4 white (Ref. 19300). Fit and glue pieces L1 and L2 with quick-drying glue. Next, do the same process with pieces L3 and L4 and glue them onto the other side of the boat. Cut to size and glue pieces L5 to L7, then sand to smooth.

**M and N.** Use masking tape to mask areas of the hull's frame and expose the shell plating. Apply a primer to the entire surface. It is advisable to use spray, and if possible grey. This will allow you to see possible defects in the shell plating. Sand the hull again once you've applied the product. Correct any imperfections with putty and repeat the process until a fine hull remains. Apply quick glue and glue pieces M1 to M34. Use template PL-01 to identify the pieces and their position on the hull. Use piece M35 as a spacer. This piece will help you keep the pieces parallel to each other. Afterwards, mask the hull again and apply primer. This operation will give pieces M1 to M34 a cross grain that must be sanded again. Use fine-grit sandpaper or sanding sponge. Glue pieces N1 to N9. Use white glue (Ref. 19200) and tweezers to carry out this operation.

**O to R.** Make and add the pieces indicated by the images to the hull. Mask the top of the boat to protect it from the paint. Paint the hull with black paint (Ref. 19301) and set apart until dry. To find the waterline, place the hull on a flat surface and hold it still. Use a pencil and a wooden block or similar to mark the line around the entire perimeter of the hull. Mask again and paint reddish brown (Ref. 19383). Make and paint the O2 piece with the same colours that were used for the hull. Paint the propellers gold (Ref. 19380). Glue pieces O2 to O5 onto the hull. Continue adding parts to the boat, some will need to be already painted. Paint the Q5 pieces ochre and glue them to the boat. To get the ochre color, mix the colors yellow, (Ref. 19306), with a few drops of brown, (Ref. 19307), and brown, (Ref. 19383). Some pieces should be painted black, (Ref. 19301), and highlight their reliefs with silver paint, (Ref. 19382).

**S to W.** Line the upper decks, sand and varnish. Build frames and fill the joints. Then paint them white, (Ref. 19300), and grey, (Ref. 19302), as shown. Add the pieces and decorations following the indications in the illustrations and diagram PL-01. Build the four chimneys by fitting together and gluing the corresponding pieces together. Notice that there are three different chimney sizes. Paint them black (Ref. 19301) and ochre. To get the ochre colour, mix the yellow colours (Ref. 19306) with a few drops of brown (Ref. 19307) and brown (Ref. 19383).

**X to Z.** Paint pieces X21 and X22 green, (Ref. 19314), and black (Ref. 19301), and darken them with brown paint, (Ref. 19307). The X23 pieces must be painted brown, (Ref. 19307). The Y25 pieces must be painted white, (Ref. 19300), and yellow, (Ref. 19306). Pieces Y21 and Z5 must be painted white, (Ref. 19300), and red, (Ref. 19310). To make parts Z58, Z59, and Z60, place three Z57 parts on a masking tape. Cut out and glue the figures from the template on top and cut the plates to the indicated shape. Then add parts B, and paint ochre. Complete the boat by adding the pieces indicated by the images.

## **MASTS AND SPARS**

In order to make up the masts the first step is to cut the rods to size, as indicated in the parts list, or by taking measurements directly from the plans, which are printed in 1/1 scale.

All of the masts and spars have to have a certain conical shape, which they will have to be given.

In order to achieve this conical shape for the masts, sand down the rod (using a sander), increasing the amount of sanding down as you get closer to the end at which you want to decrease the diameter. Turn the rod so that you sand it down evenly on all sides, until achieving the diameter indicated in the plan.

To achieve this conical shape for the spars carry out the above operations but in this case evenly reducing the diameter at both ends of the rod.

The rods will have to be stained or painted, depending on the model that you are building.

To correctly make up the mast for this model you must take into account:

- The plans
- The close-up photos of the masts and spars
- The measurements and material descriptions of the parts list
- The "PI" parts identification sheets
- Template PL-01

The masts and spars need to be varnished, while some of the parts that make them up are meant to be painted. Examine the general and close-up photos of the masts

Once the mast and spars has been assembled and varnished fix the tackle (slings, blocks, eyebolts, clump blocks, etc.) into place on the ship. The masts will have to be fully inserted into the sockets prepared to receive them in the false keel.

## **SAILS AND RIGGING**

In order to make up the running gear for this ship follow the alphabetic order of the images printed on the plans, indicating the order for fitting the (ropes, clump blocks, blocks, sails, etc.) highlighted in red. In combination with the parts list this will serve as a guide with regard to the type of material to be used and the measurements.

A method for simulating the aging of the sails is to soak them in an infusion of tea, without boiling, and then leaving them to dry all wrinkled up. Fit them in place without ironing so that they will have a certain consistency.

**A.** Utiliser une surface plane et stable pour coller les pièces A1 et A2, et renforcer leur union avec les pièces A3. Introduire et coller les pièces indiquées sur les figures en suivant l'ordre alphanumérique. Avant de coller les couples, vérifier qu'ils s'emboîtent correctement à leur place et qu'ils pénètrent à fond dans les emboîtures de la fausse quille. Il est important que les couples soient parfaitement perpendiculaires à la fausse quille afin que les ponts s'emboîtent correctement par la suite. Pour réaliser cette opération, on utilisera de la colle blanche, (Réf. 19200).

**B et C.** Utiliser les ponts pour aligner et coller les pièces des structures indiquées sur les figures. Pour réaliser cette opération, on utilisera de la colle blanche, (Réf. 19200). Ensuite, retirer les structures des ponts et appliquer du mastic bouche-pores pour cacher les unions. Une fois que le mastic est sec, poncer les ensembles pour unifier leurs superficies. Si on n'a pas de lime plate, on peut en fabriquer une en collant un papier de verre sur un morceau de listeau. Ensuite, appliquer de la peinture de couleur blanche Anschließend weiß lackieren, (Réf.19300). On peut appliquer la peinture au pinceau ou à l'aide d'un aérographe en sachant que c'est ce dernier qui donnera une finition optimale.

**D.** Tracer une ligne longitudinale qui divise le pont B1 en deux moitiés. Commencer le bordage en plaçant la première plaque contre la ligne tracée au crayon. Coller les plaques très près les unes des autres pour dissimuler les unions. Utiliser de la colle blanche (Réf. 19200). Presser les plaques contre le pont afin qu'elles y adhèrent fermement. On recommande de placer un objet lourd et plat dessus jusqu'à ce que la colle sèche. Ensuite, retourner le pont et couper les excédents des plaques à l'aide d'un cutter. Poncer le pont de sorte à obtenir une surface fine et homogène. Ensuite, éliminer la poussière du ponçage et appliquer deux couches de vernis satiné (Réf. 19209), en ponçant la surface entre chaque couche. Procéder de la même manière avec les ponts B9, B16 et D2. Poser les ponts C1, C10 et C22 sur une surface plane. Placer les structures construites pour vérifier leur ajustement. Ensuite, coller les trois ponts entre eux et retirer les structures. Poncer et border le pont obtenu à l'aide des plaques D3. Ensuite, poncer et vernir le pont.

**E et F.** Appliquer de la colle blanche (Réf. 19200), et coller les structures de façon définitive sur les ponts. Utiliser une cale à poncer plate pour égaliser la partie supérieure des structures. Utiliser un cutter pour retirer les décorations de la feuille qui les contient. Placer les décorations en suivant les indications des figures. Ces décorations sont autoadhésives et déjà découpées. Utiliser un listeau plat ou un coton-tige pour les presser afin de les fixer fermement. Poser les ponts sur le squelette afin de vérifier leur ajustement. Ensuite, coller les ponts tel qu'indiqué sur les figures.

**G.** Retourner la coque et la poncer en allant de la proue vers la poupe. Il faut dégrossir les arêtes des couples, mais en veillant à ne pas déformer leur forme originale. Le ponçage de la coque doit être symétrique, c'est-à-dire que le côté droit doit être identique au côté gauche. Pour la zone du milieu de la coque, utiliser une cale à poncer plus grande. Le ponçage doit être progressif et doux. Vérifier à l'aide d'un listeau que le ponçage est correct. À cet effet, faire glisser le listeau sur les couples afin de voir s'il s'adapte bien à leur forme.

**H.** Poncer les pièces H1 et H2 avec un fin papier de verre. Ensuite, plonger ces pièces dans l'eau pendant 20 minutes. Utiliser un objet cylindrique pour courber petit à petit ces pièces. Exercer une pression sur la pièce en joignant les doigts afin d'éviter qu'elle ne casse. Utiliser un ruban de peintre pour isoler les zones des pièces et les peindre en blanc, (Réf. 19300). Ensuite, placer et coller les pièces sur la coque avec de la colle rapide.

**I à K.** Commencer le bordage de la coque avec les listeaux i1. Si les listeaux sont très secs et se cassent lorsqu'on les courbe, on peut les tremper dans l'eau pendant environ vingt minutes. Cela leur permettra de récupérer leur flexibilité. On les séchera ensuite avec un chiffon. Il faut ajuster la longueur du premier listeau et le coller avec de la colle blanche, (Réf. 19200), entre les pièces H1 et H2. Examiner les figures suivantes avant de réaliser cette opération. Coller les autres listeaux du bordé sur les couples et entre eux en utilisant de la colle blanche, puis les fixer avec des pointes. Continuer de coller les listeaux depuis la proue vers la poupe de sorte à border toute la coque. Il faut couper les pièces sur mesure et les ajuster afin qu'elles s'emboîtent dans les ouvertures. Si l'on observe une latte lâche, on peut appliquer de la colle à séchage rapide. Si l'on observe une latte enfoncée, on collera une autre latte par-dessus, puis on la poncera. Limer les têtes des pointes avec une lime plate de sorte qu'elles soient à niveau avec le bordé. Coller les renforts K2 à K5 dans la zone de poupe de la coque. Diluer un peu de colle blanche dans l'eau pour pouvoir l'appliquer légèrement et qu'elle s'infilte entre les joints des listeaux. Mettre de côté la coque jusqu'à ce que la colle sèche. Cette opération permettra d'unifier le bordage de la coque qui gagnera en consistance. Ensuite, poncer toute la coque. Elle doit avoir un aspect doux et ne pas présenter de dénivellations.

**L.** Appliquer une couche de vernis bouche-pores sur toute la surface du bordage de la coque. Lorsqu'il sera sec, poncer le bordage pour obtenir une couche fine et sans dénivellations. Poncer et peindre les pièces L1 à L4 de couleur blanche (réf. 19300). Ajuster et coller les pièces L1 et L2 en utilisant de la colle à séchage rapide. Procéder de la même manière pour coller les pièces L3 et L4 de l'autre côté du bateau. Découper sur mesure et coller les pièces L5 à L7, puis les poncer pour les adoucir.

**M et N.** Utiliser du ruban de carrossier pour masquer les zones de la structure de la coque et découvrir le bordé. Appliquer une couche primaire sur toute la surface. Il est recommandable d'utiliser un spray et, si possible, de couleur grise. Ceci permettra de voir les défauts éventuels du bordé. Après avoir appliqué le produit, poncer de nouveau la coque. Corriger les imperfections avec du mastic et répéter le processus jusqu'à l'obtention d'une coque fine. Appliquer de la colle rapide et coller les pièces M1 à M34. Utiliser le patron PL-01 pour identifier les pièces et leur position sur la coque. Utiliser la pièce M35 comme séparateur. Cette pièce vous servira à maintenir les pièces parallèles entre elles. Ensuite, masquer à nouveau la coque et appliquer une couche primaire. Les pièces M1 à M34 produiront alors un duvet qu'il faudra à nouveau poncer. Utiliser du papier de verre ou une éponge à poncer à grain fin. Coller les pièces N1 à N9. Utiliser de la colle blanche (réf. 19200) et des pinces pour réaliser cette opération.

**O à R.** Assembler et ajouter à la coque les pièces qui sont indiquées sur les photos. Masquer la partie supérieure du bateau pour le protéger de la peinture. Peindre la coque en noir (réf. 19301), et attendre qu'elle sèche. Pour trouver la ligne de flottaison, placer la coque sur une surface plane et l'immobiliser. Utiliser un crayon et un morceau de bois ou un instrument semblable pour marquer la ligne sur tout le périmètre de la coque. Masquer de nouveau et peindre en brun rougeâtre (réf. 19383). Assembler et peindre la pièce O2 dans les mêmes couleurs que la coque. Peindre les hélices en doré (réf. 19380). Coller les pièces O2 à O5 sur la coque. Continuez à ajouter des pièces au bateau, certaines devront déjà être peintes. Peignez les pièces Q5 en ocre et collez-les sur le bateau. Pour obtenir la couleur ocre, mélangez les couleurs jaune, (Réf. 19306), avec quelques gouttes de marron, (Réf. 19307), et de marron, (Réf. 19383). Certaines pièces doivent être peintes en noir, (Réf. 19301), et mettre en valeur leurs reliefs avec de la peinture argentée, (Réf. 19382).

**S à W.** Border les ponts de la superstructure, puis les poncer et les vernir. Construire les structures et appliquer du mastic pour cacher les unions. Ensuite, les peindre en blanc, (Réf. 19300), et gris, (Réf. 19302), tel qu'indiqué sur les figures. Ajouter les pièces et les décorations en suivant les indications des figures et du patron PL-01. Construire les quatre cheminées en emboîtant et en collant les pièces correspondantes. Il faut signaler qu'il y a trois dimensions différentes de cheminée. Peindre ces pièces en noir (réf. 19301) et en ocre. Pour obtenir la couleur ocre, mélanger la couleur jaune (réf. 19306) avec quelques gouttes de brun (réf. 19307) et du brun (réf. 19383).

**X à Z.** Peindre les pièces X21 et X22 en vert, (Réf. 19314) et en noir (Réf. 19301), et les assombrir avec de la peinture brune, (Réf. 19307). Les pièces X23 doivent être peintes en marron, (Réf. 19307). Les pièces Y25 doivent être peintes en blanc (Réf. 19300) et en jaune (Réf. 19306). Les pièces Y21 et Z5 doivent être peintes en blanc (Réf. 19300) et en rouge (Réf. 19310). Pour fabriquer les pièces Z58, Z59 et Z60, placez trois pièces Z57 sur un ruban de masquage. Découpez et collez les figures du gabarit sur le dessus et découpez les plaques à la forme indiquée. Ajoutez ensuite les parties B et peignez de l'ocre. Complétez le bateau en ajoutant les pièces indiquées par les images.

## MÂTURE

La première chose à faire pour confectionner les mâts est de couper les baguettes aux dimensions indiquées dans la liste des pièces ou de prendre ces mesures directement des plans qui sont imprimés à l'échelle 1/1.

Tous les mâts et les vergues possèdent une certaine conicité qui doit être travaillée.

Pour réaliser la conicité des mâts, poncer les baguettes (avec une ponceuse) en augmentant le dégrossissage au fur et à mesure qu'on s'approche de l'extrémité où l'on souhaite diminuer le diamètre. Faire rouler la baguette afin que l'usure soit égale sur tout le contour jusqu'à ce qu'on obtienne le diamètre indiqué sur le plan.

Effectuer les mêmes opérations pour réaliser la conicité des vergues mais, dans ce cas, aux deux extrémités de la baguette.

Il faudra teinter ou peindre les baguettes en fonction de la maquette qui sera construite.

Pour réaliser correctement les mâts de cette maquette, il faudra tenir compte :

- Des plans
- Des photos de détail des mâts.
- Des dimensions et de la description des matériaux de la liste des pièces.
- Des feuilles « IP » d'identification des pièces.
- Le patron PL-01

Les mâts devront être vernis et certaines des pièces qui les composent devront être peintes. Voir les photos générales de détail des mâts.

Lorsque les mâts seront montés et vernis, on placera leurs appareils (estropes, moufles, pitons, poulies, etc.) et on les attachera au bateau. Les mâts doivent être introduits de sorte qu'ils s'emboîtent à fond contre la fausse quille.

## GRÉEMENT

Pour réaliser le gréement de ce bateau, on suivra l'ordre alphabétique des figures imprimées des plans, qui indiquent l'ordre de montage (fils, caps de mouton, poulies, etc.) mis en évidence en rouge. La liste des pièces indique le type de matériaux et les dimensions à utiliser.

Pour simuler le vieillissement des voiles, on peut les faire tremper dans une infusion de thé, sans les faire bouillir, et les laisser sécher bien chiffonnées. Les voiles seront placées non repassées afin d'avoir du volume.

**A.** Usare una superficie piana e stabile per incollare i pezzi A1 e A2, e rinforzare la loro giunzione con i pezzi A3. Seguendo l'ordine alfanumerico, inserire e incollare i pezzi indicati nelle figure. Prima di incollare le coste, è necessario verificare che si adattino correttamente alla posizione "incastrandole" nelle sedi corrispondenti della falsa chiglia. È importante che le coste siano completamente perpendicolari alla falsa chiglia in modo che poi i ponti si adattino correttamente. Per questa operazione, come adesivo bisogna utilizzare la colla bianca, (Rif.19200).

**B e C.** Usare i ponti per allineare e incollare i pezzi delle strutture che sono indicate nelle immagini. Per questa operazione, come adesivo bisogna utilizzare la colla bianca, (Rif.19200). Poi, rimuovere le strutture dai ponti e applicare l'impregnante tappa-pori per coprire le giunture. Quando l'impregnante sia asciutto, scartavetrare gli assemblaggi per unificare le loro superfici. Se non si dispone di una lima piatta, se ne può realizzare una incollando della carta vetrata su un pezzo di asta. In seguito, la vernice bianca Anschließend weiß lackieren, (Rif.19300). Si può applicare la vernice a pennello o ad aerografo, considerando che quest'ultimo è il modo migliore per ottenere una finitura ottimale.

**D.** Tracciare una linea longitudinale che divida il ponte B1 in due metà. Iniziare a foderare, incollando la prima lamina secondo il tracciato segnato dalla linea della matita. Incollare le lamine ben unite in maniera tale che le giunzioni non siano visibili. Per questa operazione, come adesivo bisogna utilizzare la colla bianca, (Rif.19200). Premere le lamine sul ponte in maniera tale che aderiscano saldamente. Si consiglia di posizionare un oggetto pesante e piatto sulla parte superiore finché la colla non si sia asciugata. Poi, rigirare il ponte al contrario per ritagliare le lamine in eccesso con un taglierino. Scartavetrare il ponte fino ad ottenere una superficie fine e uniforme. Quindi rimuovere la polvere provocata dalla levigatura e applicare un paio di mani di vernice satinata, (Rif.19209), scartavetrando ulteriormente tra una mano e l'altra. Procedere allo stesso modo con i ponti B9, B16 e D2. Posare i ponti C1, C10 e C22 su una superficie piana. Posizionare le strutture che sono già state costruite per controllarne l'adattamento. Poi incollare i tre ponti tra loro e rimuovere le coste. Scartavetrare e rivestire il ponte ottenuto con le lamine D3. Quindi scartavetrare e verniciare il ponte.

**E e F.** Applicare la colla bianca, (Rif. 19200) e incollare le coste sui ponti in modo permanente. Usare una levigatrice piatta per livellare la parte superiore delle strutture. Usare un taglierino per rimuovere le decorazioni dalla lamina dove sono contenute. Collocare le decorazioni così come mostrato nelle immagini. Queste decorazioni sono autoadesive e sono già pretagliate. Usare un'asta piatta o un batuffolo di cotone per far pressione, in maniera tale che si attacchino bene. Situare i ponti sulla struttura per verificarne la corretta aderenza. Quindi, incollarli così come mostrato nelle immagini.

**G.** Capovolgere lo scafo e iniziare a scartavetrare partendo dalla prua e avanzando verso poppa. I bordi delle coste devono essere ben ripassati ma senza distorcere la loro forma originale. Lo scafo deve essere levigato simmetricamente, cioè il lato destro deve essere uguale al sinistro. Per la parte centrale dello scafo, usare un pulitore con carta abrasiva che abbia una superficie maggiore. La levigatura deve essere progressiva e liscia. Usare un'asta per controllare che la levigatura sia corretta. Per farlo, far scorrere l'asta sulle coste per vedere come si conforma alla loro forma.

**H.** Scartavetrare le parti H1 e H2 con carta vetrata fine. Poi metterli a bagno in acqua per circa 20 minuti. Usare un oggetto cilindrico per piegare gradualmente le parti. Si deve premere il pezzo con le dita molto vicine per evitare che si rompa. Utilizzare un nastro da pittore per isolare le aree dei pezzi e dipingerli di bianco, (Rif.19300). Poi collocare e incollare i pezzi sullo scafo con la colla a presa rapida.

**Da I a K.** Iniziare a rivestire lo scafo con le aste i1. Se le aste sono troppo secche si corre il rischio che si rompano quando vengono piegate, quindi è meglio immergerle in acqua per circa 20 minuti. Questo le renderà di nuovo elastici. In seguito, asciugatele con un panno. Bisogna regolare la lunghezza della prima asta e incollarla con la colla bianca tra i pezzi H1 e H2. Osservare le seguenti immagini prima di procedere. Le altre aste del rivestimento devono essere incollate alle coste e tra loro con colla bianca, (Rif. 19200), e fissate con chiodini. Continuare ad incollare le aste da prua a poppa per allineare l'intero scafo. I pezzi devono essere tagliati a misura e adattati ai fori. Se in qualche punto è rimasto qualche pezzo non incollato, applicare della colla ad asciugatura rapida. Se una delle aste è rimasta più bassa, incollarne un'altra sopra e poi scartavetrare. Limare le teste dei chiodini con una lima piatta fino a quando non siano a filo con il rivestimento. Incollare i rinforzi da K2 a K5 nella zona posteriore dello scafo. Diluire un po' di colla bianca con dell'acqua in modo da poterla applicare leggermente e farla penetrare tra i giunti delle aste. Mettere lo scafo da parte finché la colla non si asciughi. Con questa operazione si unificherà il fasciame dello scafo e acquirerà maggior consistenza. Poi scartavetrare l'intero scafo. Deve risultare ben liscio e privo di dislivelli.

**L.** Applicare uno strato di stucco turapori su tutta la superficie del fasciame dello scafo. Una volta asciutto, scartavetrare l'intera superficie in modo da lasciarla liscia e uniforme. Scartavetrare e verniciare le parti da L1 a L4 di bianco, (Rif. 19300). Montare e incollare i pezzi L1 e L2 con colla a presa rapida. Procedere allo stesso modo per incollare i pezzi L3 e L4 sull'altro lato della barca. Tagliare a misura e incollare i pezzi da L5 a L7 e scartavetrare per lisciare.

**M e N.** Usare il nastro adesivo per mascherare le aree della struttura dello scafo e lasciare allo scopeto solo il fasciame. Applicare un primer su tutta la superficie. Si consiglia di usare un primer spray, preferibilmente grigio, che permetterà di mostrare eventuali difetti della fasciatura. Dopo aver applicato il prodotto, scartavetrare di nuovo lo scafo. Correggere le imperfezioni con lo stucco e ripetere il processo fino a quando lo scafo non rimanga ben liscio. Applicare la colla rapida e incollare le parti da M1 a M34. Usare la sagoma PL-01 per identificare le parti e la loro posizione sullo scafo. Utilizzare il pezzo M35 come separatore. Questo pezzo sarà utilizzato per mantenere le parti parallele tra loro. In seguito, mascherare di nuovo lo scafo e applicare il primer; con questa operazione, nei pezzi da M1 a M34 si produrrà un contrasto che dovrà essere scartavetrato di nuovo. Usare carta vetrata a grana fine o una spugna abrasiva fine. Incollare le parti da N1 a N9. Per questa operazione usare la colla bianca (Rif. 19200) e le pinzette.

**Da O a R.** Realizzare e aggiungere allo scafo le parti indicate nelle immagini. Mascherare la parte superiore della barca per proteggerla dalla vernice. Dipingere lo scafo con vernice nera (Rif. 19301), e mettere da parte ad asciugare. Per trovare la linea di galleggiamento, mettete lo scafo su una superficie piana e immobilizzarlo. Usare una matita e un blocco di legno o simile per segnare la linea intorno al perimetro dello scafo. Mascherare di nuovo e dipingere di marrone rossastro, (Rif. 19383). Dipingere il pezzo O2 con gli stessi colori dello scafo. Dipingere le eliche in oro, (Rif. 19380). Incollare le parti da O2 a O5 allo scafo. Continua ad aggiungere parti alla barca, alcune dovranno essere già verniciate. Dipingi i pezzi Q5 ocra e incollali alla barca. Per ottenere il colore ocra, mescolare i colori giallo, (Rif. 19306), con qualche goccia di marrone, (Rif. 19307) e marrone, (Rif. 19383). Alcuni pezzi dovrebbero essere dipinti di nero, (Rif. 19301), ed evidenziare i loro rilievi con vernice argentata, (Rif. 19382).

**Da S a W.** Rivestire i ponti della sovrastruttura, scartavetrarli e verniciarli. Costruire le strutture e applicare stucco per coprire le giunzioni. Quindi dipingerli di bianco, (Rif. 19300), e grigio, (Rif. 19302), come mostrato nelle foto. Aggiungere le parti e le decorazioni seguendo le indicazioni delle immagini e il modello PL-01. Costruire i quattro comignoli incastrando e incollando insieme i corrispondenti pezzi. Si noti che ci sono tre diverse misure di comignolo. Dipingerli di nero (Rif. 19301), e di ocra. Per ottenere il colore ocra, mescolare il giallo (Rif. 19306), con alcune gocce di marrone (Rif. 19307), e con l'altro marrone (Rif. 19383).

**Da X alla Z.** Dipingi i pezzi X21 e X22 in verde (Rif. 19314) e nero (Rif. 19301) e scurili con vernice marrone (Rif. 19307). I pezzi X23 devono essere verniciati di marrone, (Rif. 19307). I pezzi Y25 devono essere verniciati di bianco (Rif. 19300) e giallo (Rif. 19306). I pezzi Y21 e Z5 devono essere verniciati di bianco (Rif. 19300) e rosso (Rif. 19310). Per realizzare le parti Z58, Z59 e Z60, posizionare tre parti Z57 su un nastro adesivo. Ritaglia e incolla le figure dal modello in alto e taglia i piatti nella forma indicata. Quindi aggiungi le parti B e dipingi l'ocra. Completa la barca aggiungendo i pezzi indicati dalle immagini.

## **ALBERATURA**

Per realizzare l'alberatura, il primo passo da seguire sarà quello di tagliare le aste secondo le misure indicate nell'elenco dei pezzi, oppure prenderle direttamente dalle planimetrie che sono stampate in scala 1/1.

Tutti gli alberi e i pennoni hanno una certa conicità che si dovrà ottenere.

Per ottenere la conicità degli alberi, occorre scartavetrare le aste (con una smerigliatrice), aumentando l'azione della stessa a misura che ci si avvicina all'estremità dove si deve diminuire il diametro. Far girare l'asta affinché la smerigliatura sia uguale su tutto il contorno, fino ad arrivare al diametro indicato nella planimetria.

Per ottenere la conicità dei pennoni, realizzare le stesse operazioni, ma in questo caso su entrambe le estremità dell'asta. Si dovranno verniciare o tingere le aste in funzione del modello che si stia realizzando.

Per realizzare gli alberi di questo modello in maniera corretta si dovranno utilizzare:

- Le planimetrie;
- Le foto dettagliate degli alberi;
- Le misure e la descrizione dei materiali nell'elenco dei pezzi;
- Le pagine "IP" con l'identificazione dei pezzi.
- La sagoma PL-01

Gli alberi devono essere smaltati ed alcuni dei pezzi che li compongono devono essere verniciati. Vedi le foto generali dettagliate degli alberi.

Una volta montati e smaltati, devono essere collocati gli attrezzi (stropi, quarnali, golfare, bozzelli, ecc.) e fissati al vascello.

Gli alberi devono essere introdotti fino in fondo negli appositi incastrati della falsa chiglia.

## **SARTIA**

Per elaborare la sartia di questo vascello occorre seguire l'ordine alfabetico delle figure stampate delle planimetrie, che indicano l'ordine di collocazione delle cime, delle bigotte, dei bozzelli, delle vele, ecc., risaltati in colore rosso. L'elenco dei pezzi serve ad orientare in merito al tipo di materiali ed alle misure da utilizzare.

Per simulare l'invecchiamento delle vele, queste possono essere bagnate con te, senza farle bollire, e poi lasciarle asciugare mantenendole ben arrugate.

Poi si collocano senza stirarle, affinché mantengano corpo.

**A.** Auf einer ebenen und stabilen Oberfläche die Teile A1 und A2 zusammenkleben und die Verbindung mit den Teilen A3 verstärken. Die auf den Abbildungen gezeigten Teile in der angegebenen Reihenfolge einsetzen und aufkleben. Vor dem Aufkleben der Spanten sicherstellen, dass die sie korrekt sitzen und mit den dazugehörigen Einkerbungen des falschen Kiels abschließen. Die Spanten müssen vollkommen senkrecht auf dem falschen Kiel stehen, damit danach die Decks gut eingesetzt werden können. Dazu muss weißer Kleber (Tischlerleim) verwendet werden, (Ref. 19200).

**B und C.** Die Decks verwenden, um die Teile der auf den Abbildungen gezeigten Aufbauten auszurichten und aufzukleben. Dazu weißen Kleber (Tischlerleim) verwenden, (Ref.19200). Anschließend die Aufbauten wieder von den Decks entfernen und die Verbindungen mit Fugenkitt bedecken. Den Kitt trocknen lassen und anschließend mit einer Feile glätten, damit eine gleichmäßige Oberfläche entsteht. Wenn keine flache Feile zur Hand ist, einfach Schmirgelpapier um ein Stück Leiste wickeln. Anschließend weiß lackieren, (Ref.19300). Entweder mit einem Pinsel anmalen oder Airbrush verwenden, das beste Ergebnis erzielt man mit Airbrush.

**D.** Eine Längsline ziehen, mit der das Deck B1 in zwei Hälften geteilt wird. Dabei die erste Leiste an der Bleistifflinie ausrichten. Die Leisten eng zusammenkleben, damit keine Zwischenräume zu sehen sind. Dazu weißen Kleber (Tischlerleim) verwenden Dazu weißen Kleber (Tischlerleim) verwenden, (Ref.19200). Die Leisten an das Deck drücken, damit sie fest sitzen. Es wird empfohlen, einen schweren, ebenen Gegenstand auf die Leisten zu legen, bis der Leim getrocknet ist. Anschließend das Deck bäuchlings aufsetzen und die überstehenden Teile der Leisten mit einem Cutter abschneiden. Das Deck glatt feilen, so dass eine glatte und gleichmäßige Oberfläche entsteht. Anschließend den Staub mit feinem, trockenem Pinsel entfernen und einige Schichten satinierten Lack, (Ref. 19209), aufbringen und zwischen zwei Schichten die Fläche glatt schleifen. Diesen Vorgang für die Decks B9, B16 und D2 wiederholen. Die Decks C1, C10 und C22 auf eine ebene Oberfläche setzen. Die bereits fertig gestellten Aufbauten aufsetzen, um die korrekte Passform zu prüfen. Anschließend die drei Decks miteinander verkleben und die Aufbauten wieder entfernen. Das so angefertigte Deck glatt schmirgeln und mit den Leisten D3 verkleiden. Anschließend das Deck glatt schleifen und lackieren.

**E und F.** Mit weißem Leim (Ref. 19200), die Aufbauten endgültig auf die Decks kleben. Mit einem flachen Sander die Oberseite de Aufbauten auf eine Höhe bringen. Mit einem Cutter die Dekorationen aus dem entsprechenden Blatt ausschneiden. Die Dekorationen wie auf den Abbildungen gezeigt anbringen. Die Dekorationen sind selbstklebend und vorgeschritten. Eine flache Leiste oder ein Wattestäbchen verwenden, um sie anzudrücken, damit sie fest haften. Die Decks auf das Schiffsskelett setzen, um die korrekte Passform zu prüfen. Anschließend wie auf den Abbildungen gezeigt aufkleben.

**G.** Den Rumpf mit der Oberseite nach unten anbringen und vom Bug in Richtung Heck glatt schleifen. Die Kanten der Spanten glätten, aber dabei nicht das ursprüngliche Profil verändern. Beim Glätten des Rumpfs darauf achten, dass beide Seiten symmetrisch zueinander sein müssen. Für den mittleren Rumpfbereich einen Sander mit großer Schleifoberfläche verwenden. Die Oberfläche nach und nach vorsichtig glätten. Mit der Leiste testen, ob eine gleichmäßige Oberfläche hergestellt wurde. Dazu die Leiste über die Spanten fahren und prüfen, wie sie sich der Form anpasst.

**H.** Die Teile H1 und H2 mit feinem Schmirgelpapier glätten. Anschließend 20 Minuten lang in Wasser einweichen. Die Teile dann vorsichtig mit einem zylinderförmigen Gegenstand zurechtbiegen. Das Teil mit den Fingern so andrücken, dass es nicht kaputtgeht. Mit Kreppband die Stellen abkleben, die nicht lackiert werden sollen, und dann weiß lackieren, (Ref.19300). Anschließend die Teile mit Sekundenkleber am Rumpf aufkleben.

**I bis K.** Zuerst den Schiffsrumpf mit den Leisten 1 beplanken. Wenn die Leisten sehr trocken sind, ca. 20 Minuten in Wasser einweichen, damit sie nicht brechen. Damit werden sie biegsamer. Anschließend mit einem Tuch trockenreiben. Die erste Leiste auf die passende Länge zurechtschneiden und mit weißem Leim zwischen die Teile H1 und H2 kleben, (Ref.19200). Vor dem Weitermachen die Abbildungen beachten. Die übrigen Leisten an die Spanten und aneinander kleben und mit weißem Leim und Stiften befestigen. Die Beplankung des Rumpfs fortsetzen und Leisten von Bug nach Heck aufkleben. Die Teile für die Zwischenräume nach Maß zurechtschneiden. Lose Planken mit Sekundenkleber festkleben. Wenn eine Planke zu tief sitzen sollte, eine weitere Planke darüber kleben und anschließend nachbearbeiten. Die Stiftköpfe mit einer Feile glattfeilen, bis sie auf einer Höhe mit den Plankenreihen sind. Die Verstrebungen K2 bis K5 im Heckbereich des Rumpfs aufkleben. Etwas weißen Leim mit Wasser verdünnen, um ihn leichter auftragen zu können, so dass er sich in den Zwischenräume zwischen den Leisten verteilt. Rumpf beiseite stellen, bis der Leim getrocknet ist. Mit diesem Verfahren wird die Rumpfbeplankung verbunden und gewinnt an Stabilität. Anschließend den gesamten Rumpf glatt schmirgeln. Es muss eine glatte und gleichmäßige Oberfläche entstehen.

**L.** Eine Schicht Fugenkitt auf die gesamte Oberfläche der Rumpfvorverkleidung auftragen. Nach dem Trocknen die gesamte Oberfläche glatt schleifen, so dass eine gleichmäßige Fläche entsteht. Die Teile L1 bis L4 weiß lackieren (Ref. 19300). Die Teile L1 und L2 anpassen und mit Sekundenkleber aufkleben. Auf die gleiche Weise verfahren, um die Teile L3 und L4 auf der anderen Seite des Schiffs aufzukleben. Die Teile L5 und L7 zurechtschneiden, zusammenkleben und glatt schleifen.

**M und N.** Abdeckband verwenden, um Bereiche am Rumpf abzukleben und die Beplankung freilassen. Grundierung auf die gesamte Oberfläche auftragen. Dazu am besten Sprühlack, wenn möglich in Grau, verwenden. Auf diese Weise lassen sich eventuelle Mängel in der Beplankung erkennen. Nach dem Auftragen des Produkts den Rumpf erneut abschleifen. Eventuelle Mängel mit Fugenkitt ausbessern und den Vorgang wiederholen, bis die Rumpffläche homogen ist. Sekundenkleber auftragen und die Teile M1 bis M34 aufkleben. Mithilfe der PL-01-Schablone die Teile an die vorgesehenen Stellen auf dem Rumpf setzen. Teil M35 als Abstandshalter verwenden. Dieses Teil hilft, die Teile parallel zueinander zu halten. Danach den Rumpf neu abdecken und eine Grundierung auftragen, die Teile M1 bis M34 müssen danach neu abgeschliffen werden. Dazu feinkörniges Schleifpapier oder einen feinen Schmirgelschwamm verwenden. Die Teile N1 bis N9 aufkleben. Dazu weißen Leim (Ref. 19200) und eine Pinzette verwenden.

**O bis R.** Die Teile, die auf den Abbildungen zu sehen sind, anfertigen und am Rumpf ankleben. Die Oberseite des Schiffs abdecken, um sie vor Farbe zu schützen. Den Rumpf mit schwarzer Farbe (Ref.19301) lackieren und zum Trocknen beiseite stellen. Um die Wasserlinie zu markieren, den Rumpf auf eine ebene Fläche und festhalten. Mit einem Bleistift und einem Holzklötzchen oder einem ähnlichen Gegenstand eine Linie um den Umfang des Rumpfs anbringen. Abkleben und rotbraun lackieren (Ref. 19383). Das Teil O2 in denselben Farben wie den Rumpf lackieren. Die Schiffsschrauben goldfarben (Ref. 19380) anmalen. Die Teile O2 bis O5 am Rumpf aufkleben. Fügen Sie dem Boot weitere Teile hinzu, einige müssen bereits lackiert sein. Bemalen Sie die Q5-Stücke ocker und kleben Sie sie auf das Boot. Um die ockerfarbene Farbe zu erhalten, mischen Sie die Farben Gelb (Ref. 19306) mit einigen Tropfen Braun (Ref. 19307) und Braun (Ref. 19383). Einige Stücke sollten schwarz bemalt werden (Ref. 19301) und ihre Reliefs mit Silberfarbe hervorheben (Ref. 19382).

**S bis W.** Die Deckteile der Aufbauten verkleiden, glatt schleifen und lackieren. Die Strukturen anfertigen und die Verbindungsfugen mit Kitt abdecken. Anschließend weiß, (Ref.19300), und grau lackieren, (Ref.19302), wie auf den Abbildungen gezeigt. Teile und Dekorationen wie auf den Abbildungen gezeigt mithilfe von Schablone PL-01 anbringen. Die vier Schornsteine anfertigen, indem die Teile zusammenfügt und verklebt werden. Es gibt Schornsteine in drei verschiedenen Größen. Die Schornsteine schwarz (Ref. 19301) und ockerfarben anmalen.

**X bis Z.** Teile X21 und X22 grün (Ref. 19314) und schwarz (Ref. 19301) lackieren und mit brauner Farbe abdunkeln (Ref. 19307). Die X23-Teile müssen braun lackiert werden (Ref. 19307). Die Y25-Teile müssen weiß (Ref. 19300) und gelb (Ref. 19306) lackiert werden. Die Teile Y21 und Z5 müssen weiß (Ref. 19300) und rot (Ref. 19310) lackiert werden. Um die Teile Z58, Z59 und Z60 herzustellen, legen Sie drei Z57-Teile auf ein Abdeckband. Die Figuren aus der Schablone oben ausschneiden und aufkleben und die Platten in die angegebene Form schneiden. Fügen Sie dann Teile B hinzu und malen Sie Ocker. Vervollständigen Sie das Boot, indem Sie die in den Bildern angegebenen Teile hinzufügen.

**BEMASTUNG**

Zur Herstellung der Masten müssen zuerst die Stäbe entsprechend der Maße zurecht geschnitten werden, die in der Teileliste angegeben sind oder die direkt anhand der Skizze abgemessen wurde. Die Skizzen sind im Maßstab 1/1 angefertigt.

Alle Masten und Rahen müssen leicht konisch verlaufen und vor dem Einbau entsprechen vorbereitet werden.

Um die Masten in Konusform zu bringen, müssen die Masten (mit einer Feile) zurecht geschliffen werden, und zwar in der Form, dass sie nach oben hin verjüngt werden. Die Stäbe dabei drehen und an allen Seiten gleichmäßig abschleifen, bis sie zu dem auf der Skizze angegebenen Durchmesser passen.

Um die Rahen in Konusform zu bringen, ebenso verfahren, allerdings hier an beiden Enden der Stangen. Die Stäbe in Abhängigkeit von dem Modell färben oder anmalen.

Um die Masten dieses Schiffsbaumodells richtig vorzubereiten, müssen die folgenden Punkte beachtet werden:

- Die Skizzen
- Detailfotos der Masten
- Maße und Materialien der Teileliste
- IP-Blätter zur Identifikation der Bauteile
- Schablone PL-01

Die Masten müssen lackiert werden und einige der Einzelteile der Masten müssen angemalt werden. Siehe Fotos mit allgemeiner Ansicht der Masten. Nach Aufstellung und Lackierung der Masten wird die Takelung (Stroppe, Rollenblöcke, Ösen, Blockrollen etc.) an den Masten und dann am Schiff befestigt. Die Masten müssen eingesetzt werden, bis sie an die Einkerbungen des falschen Kiels stoßen.

**TAKELAGE**

Zur Takelung des Schiffsmodells die alphabetische Reihenfolge der Abbildungen befolgen, auf denen die Anbringung der Takelung (Faden, Klampböcke, Blockrollen usw.) erläutert wird. Sie sind in Rot hervorgehoben. Auf der Teileliste sehen Sie, welche Materialien zum Bau des Modells notwendig sind.

Zur künstlichen Alterung der Segel die Stoffstücke in Tee legen (nicht kochen) und trocknen lassen, bis die Stoffe faltig werden.

Die Segel ohne vorheriges Bügeln anbringen, damit sie Volumen haben.

**Lista de piezas / Parts List / Liste des pièces / Teileliste / Elenco delle parti**

<b>Nº/No./ Nº / Nr. No</b>	<b>Cantidad / Quantity / Quantité / Menge / Quantità</b>	<b>Medidas / Measurements / Dimensions / Maße / Misure</b>	<b>Material / Material / Matériau / Material / Materiale</b>
A1-A2	1	Precortado / Precut / Prédécoupé / Vorgeschnitten / Pretagliatto / Pretagliatto	Tablero / Plywood / Planche / Sperrholz / Tavola
A3	2	Precortado / Precut / Prédécoupé / Vorgeschnitten / Pretagliatto / Pretagliatto	Tablero / Plywood / Planche / Sperrholz / Tavola
A4- A20	17	Precortado / Precut / Prédécoupé / Vorgeschnitten / Pretagliatto / Pretagliatto	Tablero / Plywood / Planche / Sperrholz / Tavola
A21	1	Precortado / Precut / Prédécoupé / Vorgeschnitten / Pretagliatto / Pretagliatto	Tablero / Plywood / Planche / Sperrholz / Tavola
A22	1	Precortado / Precut / Prédécoupé / Vorgeschnitten / Pretagliatto / Pretagliatto	Tablero / Plywood / Planche / Sperrholz / Tavola
B1	1	Precortado / Precut / Prédécoupé / Vorgeschnitten / Pretagliatto	Tablero / Plywood / Planche / Sperrholz / Tavola
B2-B8	8	Precortado / Precut / Prédécoupé / Vorgeschnitten / Pretagliatto	Tablero / Plywood / Planche / Sperrholz / Tavola
B9	1	Precortado / Precut / Prédécoupé / Vorgeschnitten / Pretagliatto	Tablero / Plywood / Planche / Sperrholz / Tavola
B10-B15	12	Precortado / Precut / Prédécoupé / Vorgeschnitten / Pretagliatto	Tablero / Plywood / Planche / Sperrholz / Tavola
B16	1	Precortado / Precut / Prédécoupé / Vorgeschnitten / Pretagliatto	Tablero / Plywood / Planche / Sperrholz / Tavola
B17-B23	11	Precortado / Precut / Prédécoupé / Vorgeschnitten / Pretagliatto	Tablero / Plywood / Planche / Sperrholz / Tavola
B24-B25	4	Precortado / Precut / Prédécoupé / Vorgeschnitten / Pretagliatto	Tablero / Plywood / Planche / Sperrholz / Tavola
B26-B28	4	Precortado / Precut / Prédécoupé / Vorgeschnitten / Pretagliatto	Tablero / Plywood / Planche / Sperrholz / Tavola
B29	1	Precortado / Precut / Prédécoupé / Vorgeschnitten / Pretagliatto	Tablero / Plywood / Planche / Sperrholz / Tavola
C1	1	Precortado / Precut / Prédécoupé / Vorgeschnitten / Pretagliatto	Tablero / Plywood / Planche / Sperrholz / Tavola
C2-C9	13	Precortado / Precut / Prédécoupé / Vorgeschnitten / Pretagliatto	Tablero / Plywood / Planche / Sperrholz / Tavola
C10	1	Precortado / Precut / Prédécoupé / Vorgeschnitten / Pretagliatto	Tablero / Plywood / Planche / Sperrholz / Tavola
C11-C21	22	Precortado / Precut / Prédécoupé / Vorgeschnitten / Pretagliatto	Tablero / Plywood / Planche / Sperrholz / Tavola
C22	1	Precortado / Precut / Prédécoupé / Vorgeschnitten / Pretagliatto	Tablero / Plywood / Planche / Sperrholz / Tavola
C23-C34	32	Precortado / Precut / Prédécoupé / Vorgeschnitten / Pretagliatto	Tablero / Plywood / Planche / Sperrholz / Tavola
D1	76	0,6x5x120	Sicomoro / Sycamore / Sycomore / Bergahorn / Sicomoro
D2	1	Precortado / Precut / Prédécoupé / Vorgeschnitten / Pretagliatto	Tablero / Plywood / Planche / Sperrholz / Tavola
D3	21	0,6x5x600	Sicomoro / Sycamore / Sycomore / Bergahorn / Sicomoro
E1-E29	32	Preformado / Preformed/ Préformé / Vorgeformt / Preformato	Vinilo / Vinyl / Vinyle / Vinyl / Vinile
F1	1	Precortado / Precut / Prédécoupé / Vorgeschnitten / Pretagliatto / Pretagliatto	Tablero / Plywood / Planche / Sperrholz / Tavola
F2	17	0,6x5x135	Sicomoro / Sycamore / Sycomore / Bergahorn / Sicomoro
F3	1	Precortado / Precut / Prédécoupé / Vorgeschnitten / Pretagliatto / Pretagliatto	Tablero / Plywood / Planche / Sperrholz / Tavola
F4	18	0,6x5x115	Sicomoro / Sycamore / Sycomore / Bergahorn / Sicomoro
F5-F39	66	Preformado / Preformed/ Préformé / Vorgeformt / Preformato	Vinilo / Vinyl / Vinyle / Vinyl / Vinile
F40	2	Preformado / Preformed/ Préformé / Vorgeformt / Preformato	Latón / Brass / Latón / Messing / Ottone
G1-G9	18	Precortado / Precut / Prédécoupé / Vorgeschnitten / Pretagliatto / Pretagliatto	Tablero / Plywood / Planche / Sperrholz / Tavola
G10	1	2x5x600	Tilo / Lime wood / Tilleul / Linde / Tiglio
H1	2	Precortado / Precut / Prédécoupé / Vorgeschnitten / Pretagliatto / Pretagliatto	Tablero / Plywood / Planche / Sperrholz / Tavola
H2	2	Precortado / Precut / Prédécoupé / Vorgeschnitten / Pretagliatto / Pretagliatto	Tablero / Plywood / Planche / Sperrholz / Tavola
i1	2	2x5x600	Tilo / Lime wood / Tilleul / Linde / Tiglio
J1	86	2x5x600	Tilo / Lime wood / Tilleul / Linde / Tiglio
K1	6	2x5x600	Tilo / Lime wood / Tilleul / Linde / Tiglio
K2-K5	8	Precortado / Precut / Prédécoupé / Vorgeschnitten / Pretagliatto / Pretagliatto	Tablero / Plywood / Planche / Sperrholz / Tavola
K6	1	Preformado / Preformed/ Préformé / Vorgeformt / Preformato	Metal / Metal / Metal / Metall / Metallo
K7	1	Precortado / Precut / Prédécoupé / Vorgeschnitten / Pretagliatto / Pretagliatto	Tablero / Plywood / Planche / Sperrholz / Tavola
L1	1	Precortado / Precut / Prédécoupé / Vorgeschnitten / Pretagliatto / Pretagliatto	Tablero / Plywood / Planche / Sperrholz / Tavola
L2	1	Precortado / Precut / Prédécoupé / Vorgeschnitten / Pretagliatto / Pretagliatto	Tablero / Plywood / Planche / Sperrholz / Tavola
L3	1	Precortado / Precut / Prédécoupé / Vorgeschnitten / Pretagliatto / Pretagliatto	Tablero / Plywood / Planche / Sperrholz / Tavola
L4	1	Precortado / Precut / Prédécoupé / Vorgeschnitten / Pretagliatto / Pretagliatto	Tablero / Plywood / Planche / Sperrholz / Tavola
L5	1	2x2x600	Tilo / Lime wood / Tilleul / Linde / Tiglio

**Lista de piezas / Parts List / Liste des pièces / Teileliste / Elenco delle parti**

<b>Nº/No./ N° / Nr. No</b>	<b>Cantidad / Quantity / Quantité / Menge / Quantità</b>	<b>Medidas / Measurements / Dimensions / Maße / Misure</b>	<b>Material / Material / Matériau / Material / Materiale</b>
L6	1	2x2x165	Tilo / Lime wood / Tilleul / Linde / Tiglio
L7	2	2x2x275	Tilo / Lime wood / Tilleul / Linde / Tiglio
M1-M34	68	Preformado / Preformed/ Préformé / Vorgeformt / Preformato	Carton / Paperboard / Carton / Papple / Cartone
M35	2	Precortado / Precut / Prédécoupé / Vorgeschnitten / Pretagliatto / Pretagliatto	Tablero / Plywood / Planche / Sperrholz / Tavola
N1	2	Preformado / Preformed/ Préformé / Vorgeformt / Preformato	Latón / Brass / Latón / Messing / Ottone
N2	42	Preformado / Preformed/ Préformé / Vorgeformt / Preformato	Latón / Brass / Latón / Messing / Ottone
N3	4	Preformado / Preformed/ Préformé / Vorgeformt / Preformato	Latón / Brass / Latón / Messing / Ottone
N4	9	Preformado / Preformed/ Préformé / Vorgeformt / Preformato	Latón / Brass / Latón / Messing / Ottone
N5-N6	4	Preformado / Preformed/ Préformé / Vorgeformt / Preformato	Latón / Brass / Latón / Messing / Ottone
N7	4	Preformado / Preformed/ Préformé / Vorgeformt / Preformato	Latón / Brass / Latón / Messing / Ottone
N8	2	Preformado / Preformed/ Préformé / Vorgeformt / Preformato	Latón / Brass / Latón / Messing / Ottone
N9	5	Preformado / Preformed/ Préformé / Vorgeformt / Preformato	Latón / Brass / Latón / Messing / Ottone
o1	2	ø4x90	Tilo / Lime wood / Tilleul / Linde / Tiglio
o2	1	Precortado / Precut / Prédécoupé / Vorgeschnitten / Pretagliatto / Pretagliatto	Tablero / Plywood / Planche / Sperrholz / Tavola
o3	12	1x3x25	Tilo / Lime wood / Tilleul / Linde / Tiglio
o4	1	Preformado / Preformed/ Préformé / Vorgeformt / Preformato	Metal / Metal / Metal / Metall / Metallo
o5-o6	2	Preformado / Preformed/ Préformé / Vorgeformt / Preformato	Metal / Metal / Metal / Metall / Metallo
P1-P2	2	Precortado / Precut / Prédécoupé / Vorgeschnitten / Pretagliatto / Pretagliatto	Tablero / Plywood / Planche / Sperrholz / Tavola
P3	21	0,6x5x600	Sicomoro / Sycamore / Sycomore / Bergahorn / Sicomoro
P4-P6	6	Precortado / Precut / Prédécoupé / Vorgeschnitten / Pretagliatto / Pretagliatto	Tablero / Plywood / Planche / Sperrholz / Tavola
P7-P9	5	Preformado / Preformed/ Préformé / Vorgeformt / Preformato	Latón / Brass / Latón / Messing / Ottone
P10	2	Preformado / Preformed/ Préformé / Vorgeformt / Preformato	Cristal / Glass / Verre / Glas / Cristallo
P11-P12	4	Precortado / Precut / Prédécoupé / Vorgeschnitten / Pretagliatto / Pretagliatto	Tablero / Plywood / Planche / Sperrholz / Tavola
P13	2	1x3x105	Tilo / Lime wood / Tilleul / Linde / Tiglio
P14	2	1x3x132	Tilo / Lime wood / Tilleul / Linde / Tiglio
Q1-Q4	20	Preformado / Preformed/ Préformé / Vorgeformt / Preformato	Latón / Brass / Latón / Messing / Ottone
Q5	5	ø1x400	Latón / Brass / Latón / Messing / Ottone
R1-R14	25	Preformado / Preformed/ Préformé / Vorgeformt / Preformato	Latón / Brass / Latón / Messing / Ottone
R15	1	Preformado / Preformed/ Préformé / Vorgeformt / Preformato	Vinilo / Vinyl / Vinyle / Vinyl / Vinile
R16	2	Preformado / Preformed/ Préformé / Vorgeformt / Preformato	Vinilo / Vinyl / Vinyle / Vinyl / Vinile
R17-R18	3	Preformado / Preformed/ Préformé / Vorgeformt / Preformato	Latón / Brass / Latón / Messing / Ottone
R19	3	Preformado / Preformed/ Préformé / Vorgeformt / Preformato	Metal / Metal / Metal / Metall / Metallo
R20	1	Preformado / Preformed/ Préformé / Vorgeformt / Preformato	Latón / Brass / Latón / Messing / Ottone
R21	1	Preformado / Preformed/ Préformé / Vorgeformt / Preformato	Metal / Metal / Metal / Metall / Metallo
R22	1	Preformado / Preformed/ Préformé / Vorgeformt / Preformato	Latón / Brass / Latón / Messing / Ottone
R23	1	Preformado / Preformed/ Préformé / Vorgeformt / Preformato	Metal / Metal / Metal / Metall / Metallo
R24-R26	4	Preformado / Preformed/ Préformé / Vorgeformt / Preformato	Latón / Brass / Latón / Messing / Ottone
R27	2	Preformado / Preformed/ Préformé / Vorgeformt / Preformato	Vinilo / Vinyl / Vinyle / Vinyl / Vinile
R28-R29	3	Preformado / Preformed/ Préformé / Vorgeformt / Preformato	Latón / Brass / Latón / Messing / Ottone
S1	1	Precortado / Precut / Prédécoupé / Vorgeschnitten / Pretagliatto / Pretagliatto	Tablero / Plywood / Planche / Sperrholz / Tavola
S2	50	0,6x5x130	Sicomoro / Sycamore / Sycomore / Bergahorn / Sicomoro
S3-S6	4	Precortado / Precut / Prédécoupé / Vorgeschnitten / Pretagliatto	Tablero / Plywood / Planche / Sperrholz / Tavola
S7-S10	5	Precortado / Precut / Prédécoupé / Vorgeschnitten / Pretagliatto	Tablero / Plywood / Planche / Sperrholz / Tavola
S11-S14	5	Precortado / Precut / Prédécoupé / Vorgeschnitten / Pretagliatto	Tablero / Plywood / Planche / Sperrholz / Tavola
S15-S19	5	Precortado / Precut / Prédécoupé / Vorgeschnitten / Pretagliatto	Tablero / Plywood / Planche / Sperrholz / Tavola



**Lista de piezas / Parts List / Liste des pièces / Teileliste / Elenco delle parti**

<b>Nº/No./ N° / Nr. No</b>	<b>Cantidad / Quantity / Quantité / Menge / Quantità</b>	<b>Medidas / Measurements / Dimensions / Maße / Misure</b>	<b>Material / Material / Matériau / Material / Materiale</b>
S20	5	Precortado / Precut / Prédécoupé / Vorgeschnitten / Pretagliatto	Tablero / Plywood / Planche / Sperrholz / Tavola
T1-T6	8	Precortado / Precut / Prédécoupé / Vorgeschnitten / Pretagliatto / Pretagliatto	Tablero / Plywood / Planche / Sperrholz / Tavola
T7-T13	7	Precortado / Precut / Prédécoupé / Vorgeschnitten / Pretagliatto	Tablero / Plywood / Planche / Sperrholz / Tavola
T14-T21	10	Precortado / Precut / Prédécoupé / Vorgeschnitten / Pretagliatto	Tablero / Plywood / Planche / Sperrholz / Tavola
T22	7	1x3x25	Tilo / Lime wood / Tilleul / Linde / Tiglio
T23	8	Preformado / Preformed/ Préformé / Vorgeformt / Preformato	Latón / Brass / Latón / Messing / Ottone
T24	1	1x5x25	Tilo / Lime wood / Tilleul / Linde / Tiglio
T25-T26	3	Preformado / Preformed/ Préformé / Vorgeformt / Preformato	Latón / Brass / Latón / Messing / Ottone
T27	16	Precortado / Precut / Prédécoupé / Vorgeschnitten / Pretagliatto	Tablero / Plywood / Planche / Sperrholz / Tavola
T28	5	Precortado / Precut / Prédécoupé / Vorgeschnitten / Pretagliatto	Tablero / Plywood / Planche / Sperrholz / Tavola
U1	1	Precortado / Precut / Prédécoupé / Vorgeschnitten / Pretagliatto / Pretagliatto	Tablero / Plywood / Planche / Sperrholz / Tavola
U2-U12	12	Preformado / Preformed/ Préformé / Vorgeformt / Preformato	Vinilo / Vinyl / Vinyle / Vinyl / Vinile
U13-U14	2	Preformado / Preformed/ Préformé / Vorgeformt / Preformato	Latón / Brass / Latón / Messing / Ottone
U15-U32	18	Preformado / Preformed/ Préformé / Vorgeformt / Preformato	Vinilo / Vinyl / Vinyle / Vinyl / Vinile
U33-U36	8	Preformado / Preformed/ Préformé / Vorgeformt / Preformato	Latón / Brass / Latón / Messing / Ottone
U37-U39	4	Preformado / Preformed/ Préformé / Vorgeformt / Preformato	Latón / Brass / Latón / Messing / Ottone
U40-U48	11	Preformado / Preformed/ Préformé / Vorgeformt / Preformato	Latón / Brass / Latón / Messing / Ottone
U49	2	1x5x9	Tilo / Lime wood / Tilleul / Linde / Tiglio
U50-U60	17	Preformado / Preformed/ Préformé / Vorgeformt / Preformato	Latón / Brass / Latón / Messing / Ottone
U61-U74	14	Preformado / Preformed/ Préformé / Vorgeformt / Preformato	Vinilo / Vinyl / Vinyle / Vinyl / Vinile
V1-V5	8	Preformado / Preformed/ Préformé / Vorgeformt / Preformato	Latón / Brass / Latón / Messing / Ottone
V6	2	Preformado / Preformed/ Préformé / Vorgeformt / Preformato	Vinilo / Vinyl / Vinyle / Vinyl / Vinile
V7-V21	17	Preformado / Preformed/ Préformé / Vorgeformt / Preformato	Latón / Brass / Latón / Messing / Ottone
V22-V30	15	Precortado / Precut / Prédécoupé / Vorgeschnitten / Pretagliatto	Tablero / Plywood / Planche / Sperrholz / Tavola
V31-V39	10	Preformado / Preformed/ Préformé / Vorgeformt / Preformato	Vinilo / Vinyl / Vinyle / Vinyl / Vinile
V40-V42	4	Preformado / Preformed/ Préformé / Vorgeformt / Preformato	Latón / Brass / Latón / Messing / Ottone
V43	2	1x5x9	Tilo / Lime wood / Tilleul / Linde / Tiglio
V44-V49	20	Precortado / Precut / Prédécoupé / Vorgeschnitten / Pretagliatto	Tablero / Plywood / Planche / Sperrholz / Tavola
V50	84	1x3x80	Tilo / Lime wood / Tilleul / Linde / Tiglio
W1-W2	4	Precortado / Precut / Prédécoupé / Vorgeschnitten / Pretagliatto / Pretagliatto	Tablero / Plywood / Planche / Sperrholz / Tavola
W3	1	Ø1x65	Latón / Brass / Latón / Messing / Ottone
W4	3	Ø1x64	Latón / Brass / Latón / Messing / Ottone
W5	1	Ø1,5x62	Latón / Brass / Latón / Messing / Ottone
W6	1	Ø1,5x58	Latón / Brass / Latón / Messing / Ottone
W7	1	Ø1x55	Latón / Brass / Latón / Messing / Ottone
W8	12	Preformado / Preformed/ Préformé / Vorgeformt / Preformato	Latón / Brass / Latón / Messing / Ottone
W9	4	Preformado / Preformed/ Préformé / Vorgeformt / Preformato	Metal / Metal / Metal / Metall / Metallo
W10	1	Ø1,5x64	Latón / Brass / Latón / Messing / Ottone
W11	1	Ø1,5x59	Latón / Brass / Latón / Messing / Ottone
W12	1	Ø1x56	Latón / Brass / Latón / Messing / Ottone
W13	1	Ø1,5x61	Latón / Brass / Latón / Messing / Ottone
W14	1	Ø1,5x65	Latón / Brass / Latón / Messing / Ottone
W15	1	Ø1x55	Latón / Brass / Latón / Messing / Ottone
W16	1	Ø1,5x65	Latón / Brass / Latón / Messing / Ottone
W17	1	Ø1,5x61	Latón / Brass / Latón / Messing / Ottone

**Lista de piezas / Parts List / Liste des pièces / Teileliste / Elenco delle parti**

<b>Nº/No./ N° / Nr. No</b>	<b>Cantidad / Quantity / Quantité / Menge / Quantità</b>	<b>Medidas / Measurements / Dimensions / Maße / Misure</b>	<b>Material / Material / Matériau / Material / Materiale</b>
W18	1	∅1x56	Latón / Brass / Latón / Messing / Ottone
W19	1	∅1x63	Latón / Brass / Latón / Messing / Ottone
W20	1	∅0,50x60	Latón / Brass / Latón / Messing / Ottone
W21	1	∅0,50x44	Latón / Brass / Latón / Messing / Ottone
W22	1	∅0,50x35	Latón / Brass / Latón / Messing / Ottone
W23	4	Preformado / Preformed/ Préformé / Vorgeformt / Preformato	Latón / Brass / Latón / Messing / Ottone
X1-X3	8	Precortado / Precut / Prédécoupé / Vorgeschnitten / Pretagliatto / Pretagliatto	Tablero / Plywood / Planche / Sperrholz / Tavola
X4-X9	26	Precortado / Precut / Prédécoupé / Vorgeschnitten / Pretagliatto / Pretagliatto	Tablero / Plywood / Planche / Sperrholz / Tavola
X10	8	Preformado / Preformed/ Préformé / Vorgeformt / Preformato	Metal / Metal / Metal / Metall / Metallo
X11	8	Preformado / Preformed/ Préformé / Vorgeformt / Preformato	Latón / Brass / Latón / Messing / Ottone
X12	6	Preformado / Preformed/ Préformé / Vorgeformt / Preformato	Metal / Metal / Metal / Metall / Metallo
X13	2	Preformado / Preformed/ Préformé / Vorgeformt / Preformato	Metal / Metal / Metal / Metall / Metallo
X14-X19	8	Preformado / Preformed/ Préformé / Vorgeformt / Preformato	Vinilo / Vinyl / Vinyle / Vinyl / Vinile
X20	8	∅0,15x75	Hilo crudo / Raw thread / Fil brut / Rohes Baumwollfaden / Filo crudo
X21	8	Preformado / Preformed/ Préformé / Vorgeformt / Preformato	Metal / Metal / Metal / Metall / Metallo
X22	3	Preformado / Preformed/ Préformé / Vorgeformt / Preformato	Metal / Metal / Metal / Metall / Metallo
X23	39	Preformado / Preformed/ Préformé / Vorgeformt / Preformato	Metal / Metal / Metal / Metall / Metallo
X24	2	Preformado / Preformed/ Préformé / Vorgeformt / Preformato	Metal / Metal / Metal / Metall / Metallo
X25	8	Preformado / Preformed/ Préformé / Vorgeformt / Preformato	Metal / Metal / Metal / Metall / Metallo
X26	2	Preformado / Preformed/ Préformé / Vorgeformt / Preformato	Metal / Metal / Metal / Metall / Metallo
X27	4	Preformado / Preformed/ Préformé / Vorgeformt / Preformato	Metal / Metal / Metal / Metall / Metallo
X28	4	Preformado / Preformed/ Préformé / Vorgeformt / Preformato	Metal / Metal / Metal / Metall / Metallo
X29	4	Preformado / Preformed/ Préformé / Vorgeformt / Preformato	Metal / Metal / Metal / Metall / Metallo
X30	22	Preformado / Preformed/ Préformé / Vorgeformt / Preformato	Metal / Metal / Metal / Metall / Metallo
X31	2	Preformado / Preformed/ Préformé / Vorgeformt / Preformato	Latón / Brass / Latón / Messing / Ottone
X32	1	Preformado / Preformed/ Préformé / Vorgeformt / Preformato	Latón / Brass / Latón / Messing / Ottone
X33	1	Preformado / Preformed/ Préformé / Vorgeformt / Preformato	Latón / Brass / Latón / Messing / Ottone
X34	2	Precortado / Precut / Prédécoupé / Vorgeschnitten / Pretagliatto / Pretagliatto	Tablero / Plywood / Planche / Sperrholz / Tavola
X35	6	Preformado / Preformed/ Préformé / Vorgeformt / Preformato	Latón / Brass / Latón / Messing / Ottone
X36	6	Preformado / Preformed/ Préformé / Vorgeformt / Preformato	Latón / Brass / Latón / Messing / Ottone
X37	2	Preformado / Preformed/ Préformé / Vorgeformt / Preformato	Latón / Brass / Latón / Messing / Ottone
X38-X39	20	Preformado / Preformed/ Préformé / Vorgeformt / Preformato	Latón / Brass / Latón / Messing / Ottone
X40	20	Preformado / Preformed/ Préformé / Vorgeformt / Preformato	Latón / Brass / Latón / Messing / Ottone
X41	32	Preformado / Preformed/ Préformé / Vorgeformt / Preformato	Latón / Brass / Latón / Messing / Ottone
Y1	2	Preformado / Preformed/ Préformé / Vorgeformt / Preformato	Latón / Brass / Latón / Messing / Ottone
Y2	2	Preformado / Preformed/ Préformé / Vorgeformt / Preformato	Latón / Brass / Latón / Messing / Ottone
Y3	2	Preformado / Preformed/ Préformé / Vorgeformt / Preformato	Cristal / Glass / Verre / Glas / Cristallo
Y4	2	Preformado / Preformed/ Préformé / Vorgeformt / Preformato	Latón / Brass / Latón / Messing / Ottone
Y5	13	∅1x5	Latón / Brass / Latón / Messing / Ottone
Y6	58	∅1x4	Latón / Brass / Latón / Messing / Ottone
Y7	6	∅1x8	Latón / Brass / Latón / Messing / Ottone
Y8	2	Preformado / Preformed/ Préformé / Vorgeformt / Preformato	Metal / Metal / Metal / Metall / Metallo
Y9	1	Preformado / Preformed/ Préformé / Vorgeformt / Preformato	Metal / Metal / Metal / Metall / Metallo
Y10	6	Preformado / Preformed/ Préformé / Vorgeformt / Preformato	Vinilo / Vinyl / Vinyle / Vinyl / Vinile
Y11	2	Preformado / Preformed/ Préformé / Vorgeformt / Preformato	Vinilo / Vinyl / Vinyle / Vinyl / Vinile



**Lista de piezas / Parts List / Liste des pièces / Teileliste / Elenco delle parti**

<b>Nº/No./ N° / Nr. No</b>	<b>Cantidad / Quantity / Quantité / Menge / Quantità</b>	<b>Medidas / Measurements / Dimensions / Maße / Misure</b>	<b>Material / Material / Matériau / Material / Materiale</b>
Y12	6	Preformado / Prefomed/ Préformé / Vorgeformt / Preformato	Latón / Brass / Latón / Messing / Ottone
Y13	1	Preformado / Prefomed/ Préformé / Vorgeformt / Preformato	Metal / Metal / Metal / Metall / Metallo
Y14	2	Preformado / Prefomed/ Préformé / Vorgeformt / Preformato	Metal / Metal / Metal / Metall / Metallo
Y15	2	Preformado / Prefomed/ Préformé / Vorgeformt / Preformato	Metal / Metal / Metal / Metall / Metallo
Y16-Y17	7	Preformado / Prefomed/ Préformé / Vorgeformt / Preformato	Latón / Brass / Latón / Messing / Ottone
Y18	3	Preformado / Prefomed/ Préformé / Vorgeformt / Preformato	Metal / Metal / Metal / Metall / Metallo
Y19	3	∅0,15x150	Hilo crudo / Raw thread / Fil brut / Rohes Baumwollfaden / Filo crudo
Y20	3	∅1x6	Latón / Brass / Latón / Messing / Ottone
Y21	10	Preformado / Prefomed/ Préformé / Vorgeformt / Preformato	Metal / Metal / Metal / Metall / Metallo
Y22	1	Preformado / Prefomed/ Préformé / Vorgeformt / Preformato	Metal / Metal / Metal / Metall / Metallo
Y23	1	∅0,5x20	Latón / Brass / Latón / Messing / Ottone
Y24	1	∅0,15x70	Hilo crudo / Raw thread / Fil brut / Rohes Baumwollfaden / Filo crudo
Y25	3	Preformado / Prefomed/ Préformé / Vorgeformt / Preformato	Metal / Metal / Metal / Metall / Metallo
Y26	2	Preformado / Prefomed/ Préformé / Vorgeformt / Preformato	Metal / Metal / Metal / Metall / Metallo
Y27	2	Preformado / Prefomed/ Préformé / Vorgeformt / Preformato	Latón / Brass / Latón / Messing / Ottone
Y28	2	∅1x10	Latón / Brass / Latón / Messing / Ottone
Z1	6	2x10x18	Tilo / Lime wood / Tilleul / Linde / Tiglio
Z2	2	2x15x18	Tilo / Lime wood / Tilleul / Linde / Tiglio
Z3	12	0,6x5x12	Sicomoro / Sycamore / Sycomore / Bergahorn / Sicomoro
Z4	4	0,6x5x17	Sicomoro / Sycamore / Sycomore / Bergahorn / Sicomoro
Z5	1	Preformado / Prefomed/ Préformé / Vorgeformt / Preformato	Metal / Metal / Metal / Metall / Metallo
Z6	2	Preformado / Prefomed/ Préformé / Vorgeformt / Preformato	Metal / Metal / Metal / Metall / Metallo
Z7	4	Preformado / Prefomed/ Préformé / Vorgeformt / Preformato	Metal / Metal / Metal / Metall / Metallo
Z8	2	Preformado / Prefomed/ Préformé / Vorgeformt / Preformato	Metal / Metal / Metal / Metall / Metallo
Z9	48	∅0,15x120	Hilo crudo / Raw thread / Fil brut / Rohes Baumwollfaden / Filo crudo
Z10	9	Preformado / Prefomed/ Préformé / Vorgeformt / Preformato	Metal / Metal / Metal / Metall / Metallo
Z11	3	Preformado / Prefomed/ Préformé / Vorgeformt / Preformato	Metal / Metal / Metal / Metall / Metallo
Z12	1	Preformado / Prefomed/ Préformé / Vorgeformt / Preformato	Metal / Metal / Metal / Metall / Metallo
Z13	2	Preformado / Prefomed/ Préformé / Vorgeformt / Preformato	Metal / Metal / Metal / Metall / Metallo
Z14	1	Preformado / Prefomed/ Préformé / Vorgeformt / Preformato	Metal / Metal / Metal / Metall / Metallo
Z15	1	Preformado / Prefomed/ Préformé / Vorgeformt / Preformato	Metal / Metal / Metal / Metall / Metallo
Z16	1	Preformado / Prefomed/ Préformé / Vorgeformt / Preformato	Metal / Metal / Metal / Metall / Metallo
Z17	8	Preformado / Prefomed/ Préformé / Vorgeformt / Preformato	Latón / Brass / Latón / Messing / Ottone
Z18	2	Preformado / Prefomed/ Préformé / Vorgeformt / Preformato	Metal / Metal / Metal / Metall / Metallo
Z19	2	Preformado / Prefomed/ Préformé / Vorgeformt / Preformato	Metal / Metal / Metal / Metall / Metallo
Z20	1	∅1x28	Latón / Brass / Latón / Messing / Ottone
Z21	1	Preformado / Prefomed/ Préformé / Vorgeformt / Preformato	Metal / Metal / Metal / Metall / Metallo
Z22	2	Precortado / Precut / Prédécoupé / Vorgeschnitten / Pretagliatto	Tablero / Plywood / Planche / Sperrholz / Tavola
Z23	1	Preformado / Prefomed/ Préformé / Vorgeformt / Preformato	Metal / Metal / Metal / Metall / Metallo
Z24	1	Preformado / Prefomed/ Préformé / Vorgeformt / Preformato	Metal / Metal / Metal / Metall / Metallo
Z25	3	Preformado / Prefomed/ Préformé / Vorgeformt / Preformato	Metal / Metal / Metal / Metall / Metallo
Z26	1	Preformado / Prefomed/ Préformé / Vorgeformt / Preformato	Metal / Metal / Metal / Metall / Metallo
Z27	1	Preformado / Prefomed/ Préformé / Vorgeformt / Preformato	Metal / Metal / Metal / Metall / Metallo
Z28	1	Preformado / Prefomed/ Préformé / Vorgeformt / Preformato	Metal / Metal / Metal / Metall / Metallo
Z29	1	Preformado / Prefomed/ Préformé / Vorgeformt / Preformato	Metal / Metal / Metal / Metall / Metallo

**Lista de piezas / Parts List / Liste des pièces / Teileliste / Elenco delle parti**

<b>Nº/No./ N° / Nr. No</b>	<b>Cantidad / Quantity / Quantité / Menge / Quantità</b>	<b>Medidas / Measurements / Dimensions / Maße / Misure</b>	<b>Material / Material / Matériau / Material / Materiale</b>
Z30	1	Preformado / Preformed/ Préformé / Vorgeformt / Preformato	Metal / Metal / Metal / Metall / Metallo
Z31	1	Preformado / Preformed/ Préformé / Vorgeformt / Preformato	Metal / Metal / Metal / Metall / Metallo
Z32	1	Preformado / Preformed/ Préformé / Vorgeformt / Preformato	Metal / Metal / Metal / Metall / Metallo
Z33	9	∅1x48	Latón / Brass / Latón / Messing / Ottone
Z34	2	Preformado / Preformed/ Préformé / Vorgeformt / Preformato	Latón / Brass / Latón / Messing / Ottone
Z35	2	Preformado / Preformed/ Préformé / Vorgeformt / Preformato	Latón / Brass / Latón / Messing / Ottone
Z36	1	∅1x35	Latón / Brass / Latón / Messing / Ottone
Z37	2	Preformado / Preformed/ Préformé / Vorgeformt / Preformato	Latón / Brass / Latón / Messing / Ottone
Z38	2	Preformado / Preformed/ Préformé / Vorgeformt / Preformato	Cristal / Glass / Verre / Glas / Cristallo
Z39	1	Precortado / Precut / Prédécoupé / Vorgeschnitten / Pretagliatto / Pretagliatto	Tablero / Plywood / Planche / Sperrholz / Tavola
Z40	2	0,6x5x100	Sicomoro / Sycamore / Sycomore / Bergahorn / Sicomoro
Z41	2	3x3x10	Tilo / Lime wood / Tilleul / Linde / Tiglio
Z42	2	Precortado / Precut / Prédécoupé / Vorgeschnitten / Pretagliatto / Pretagliatto	Tablero / Plywood / Planche / Sperrholz / Tavola
Z43	5	∅1x8	Latón / Brass / Latón / Messing / Ottone
Z44-Z48	8	Preformado / Preformed/ Préformé / Vorgeformt / Preformato	Latón / Brass / Latón / Messing / Ottone
Z49	1	Preformado / Preformed/ Préformé / Vorgeformt / Preformato	Latón / Brass / Latón / Messing / Ottone
Z50-Z51	3	Preformado / Preformed/ Préformé / Vorgeformt / Preformato	Latón / Brass / Latón / Messing / Ottone
Z52-Z53	2	Preformado / Preformed/ Préformé / Vorgeformt / Preformato	Latón / Brass / Latón / Messing / Ottone
Z54	2	Preformado / Preformed/ Préformé / Vorgeformt / Preformato	Latón / Brass / Latón / Messing / Ottone
Z55	1	Preformado / Preformed/ Préformé / Vorgeformt / Preformato	Latón / Brass / Latón / Messing / Ottone
Z56	1	Preformado / Preformed/ Préformé / Vorgeformt / Preformato	Latón / Brass / Latón / Messing / Ottone
Z57	60	0.6x5x40	Sicomoro / Sycamore / Sycomore / Bergahorn / Sicomoro
Z58-Z60	3	Preformado / Preformed/ Préformé / Vorgeformt / Preformato	Papel / Paper / Papier / Papier / Carta
Z61	14	Preformado / Preformed/ Préformé / Vorgeformt / Preformato	Metal / Metal / Metal / Metall / Metallo
Z62	16	∅0,15x70	Hilo crudo / Raw thread / Fil brut / Rohes Baumwollfaden / Filo crudo
Z63	36	1x3x8	Tilo / Lime wood / Tilleul / Linde / Tiglio
Z64	4	Preformado / Preformed/ Préformé / Vorgeformt / Preformato	Metal / Metal / Metal / Metall / Metallo
Z65	2	Preformado / Preformed/ Préformé / Vorgeformt / Preformato	Metal / Metal / Metal / Metall / Metallo
Z66	4	∅0.15x75	Hilo crudo / Raw thread / Fil brut / Rohes Baumwollfaden / Filo crudo
Z67	32	∅0,15x100	Hilo crudo / Raw thread / Fil brut / Rohes Baumwollfaden / Filo crudo
X-Y	2	Precortado / Precut / Prédécoupé / Vorgeschnitten / Pretagliatto	Tablero / Plywood / Planche / Sperrholz / Tavola
Z	2	Precortado / Precut / Prédécoupé / Vorgeschnitten / Pretagliatto	Tablero / Plywood / Planche / Sperrholz / Tavola

**Lista de piezas / Parts List / Liste des pièces / Teileliste / Elenco delle parti**

<b>Nº/No./ N° / Nr. No</b>	<b>Descripción / Description / Description / Beschreibung / Descrizione</b>	<b>Cantidad / Quantity / Quantité / Menge / Quantità</b>	<b>Medidas / Measurements / Dimensions / Maße / Misure</b>	<b>Material / Material / Matériau / Material / Materiale</b>
A		1200	10	Metal / Metal / Metal / Metall / Metallo
B		200	15	Latón / Brass / Latón / Messing / Ottone
H		2	∅3	Latón / Brass / Laiton / Messing / Ottone



Accede a vídeos tutoriales fotografiando los códigos QR.  
Access tutorial videos photographing QR codes.  
Accédez aux didacticiels vidéo photographiant les codes QR.  
Greifen Sie auf Video-Tutorials zu, die QR-Code fotografieren.  
Accedi ai video tutorial fotografando i codici QR.  
Доступ к видеоурокам фотографирования QR-кодов.

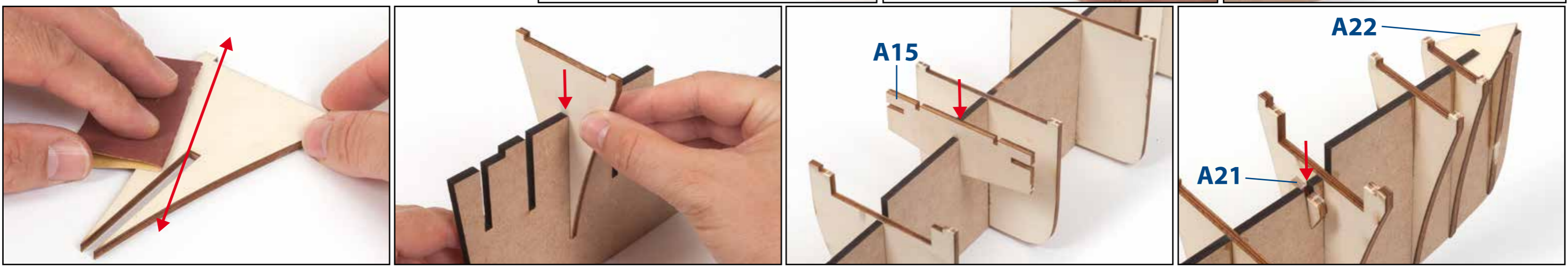
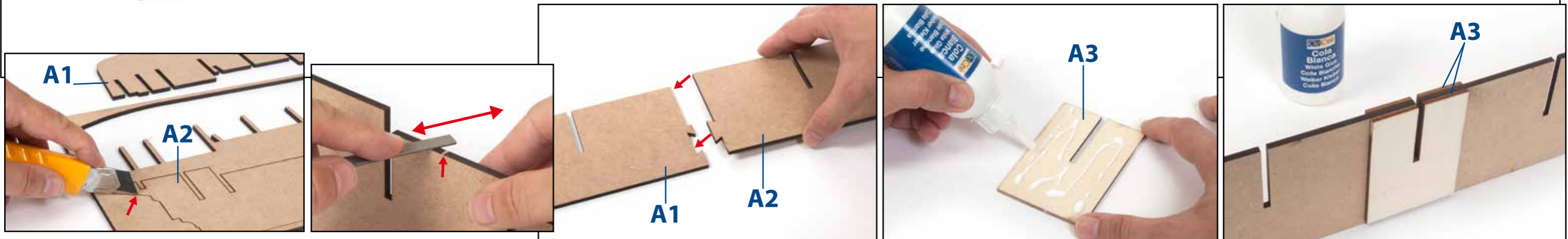
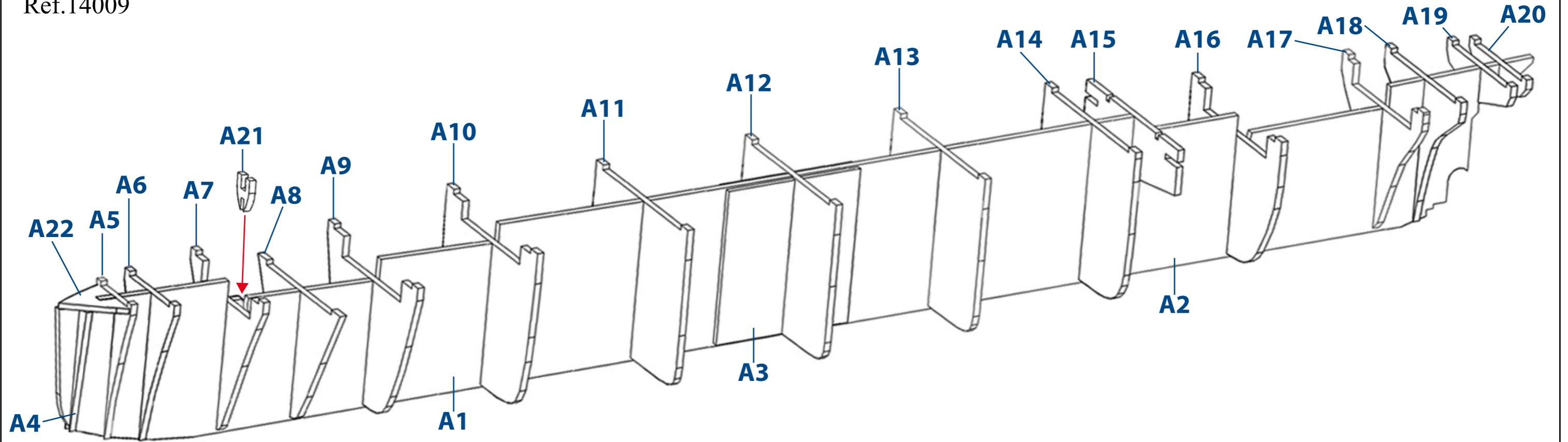

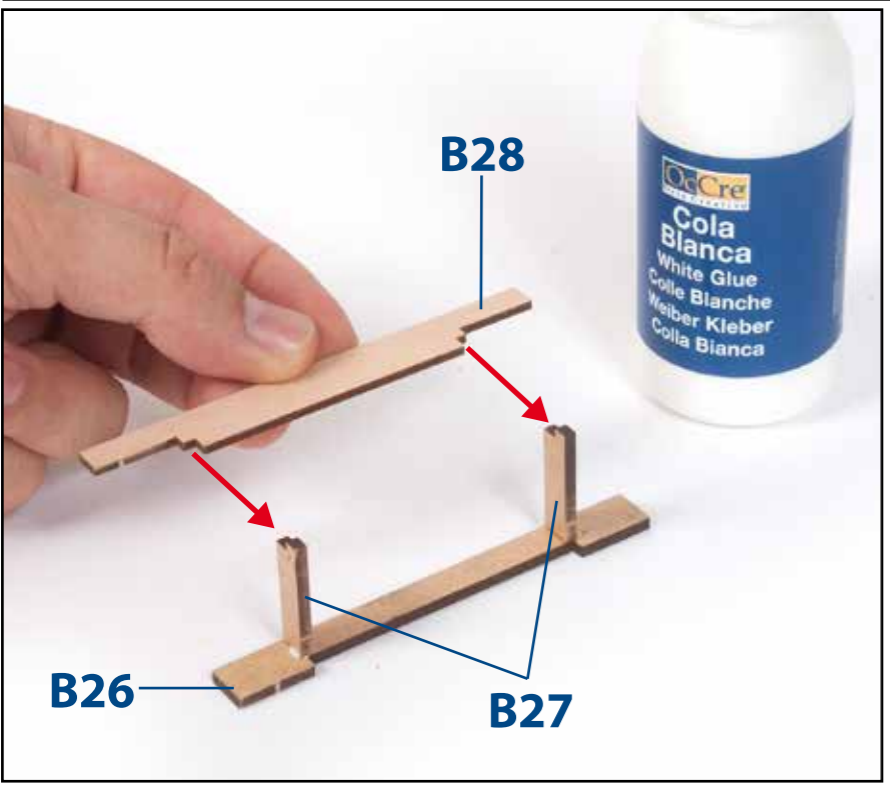
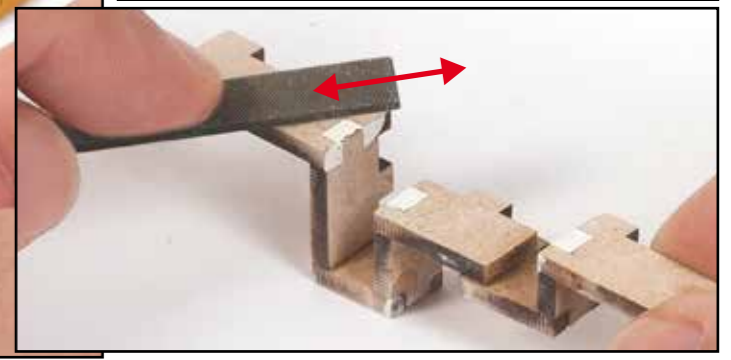
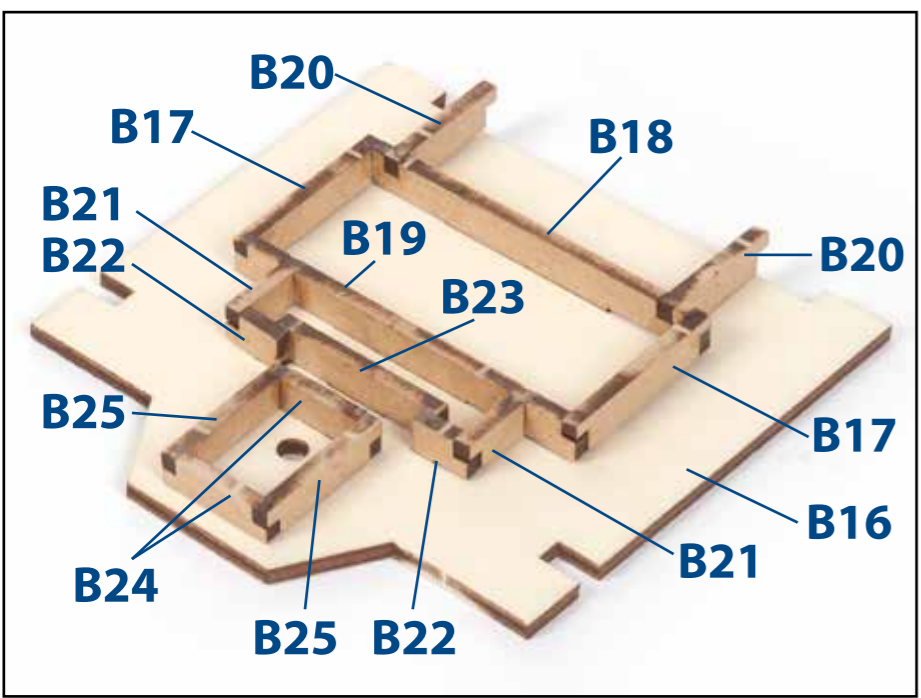
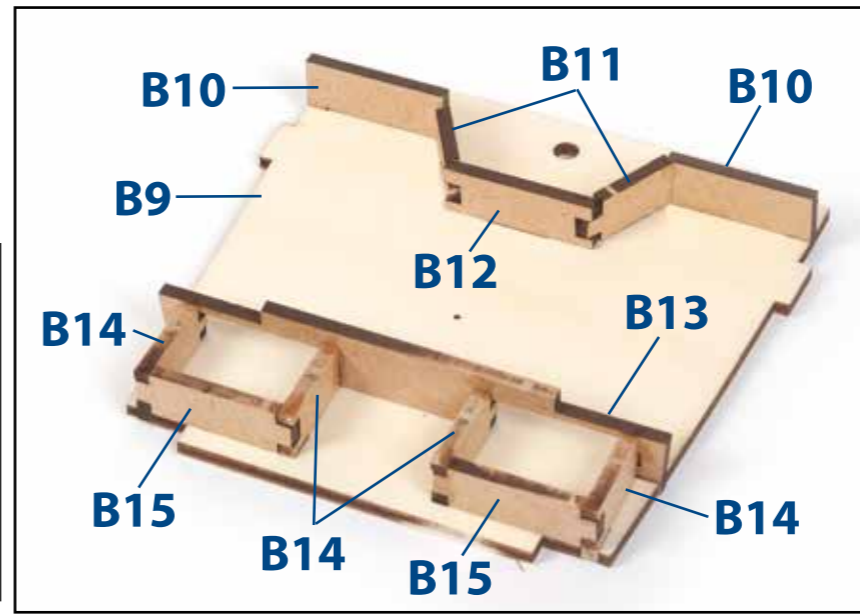
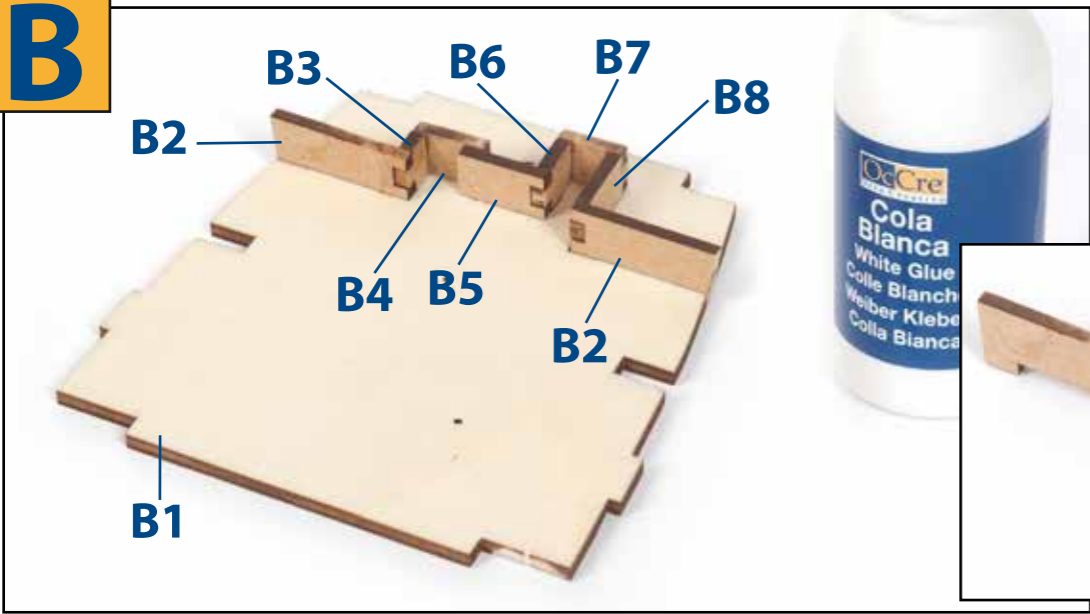
**B**

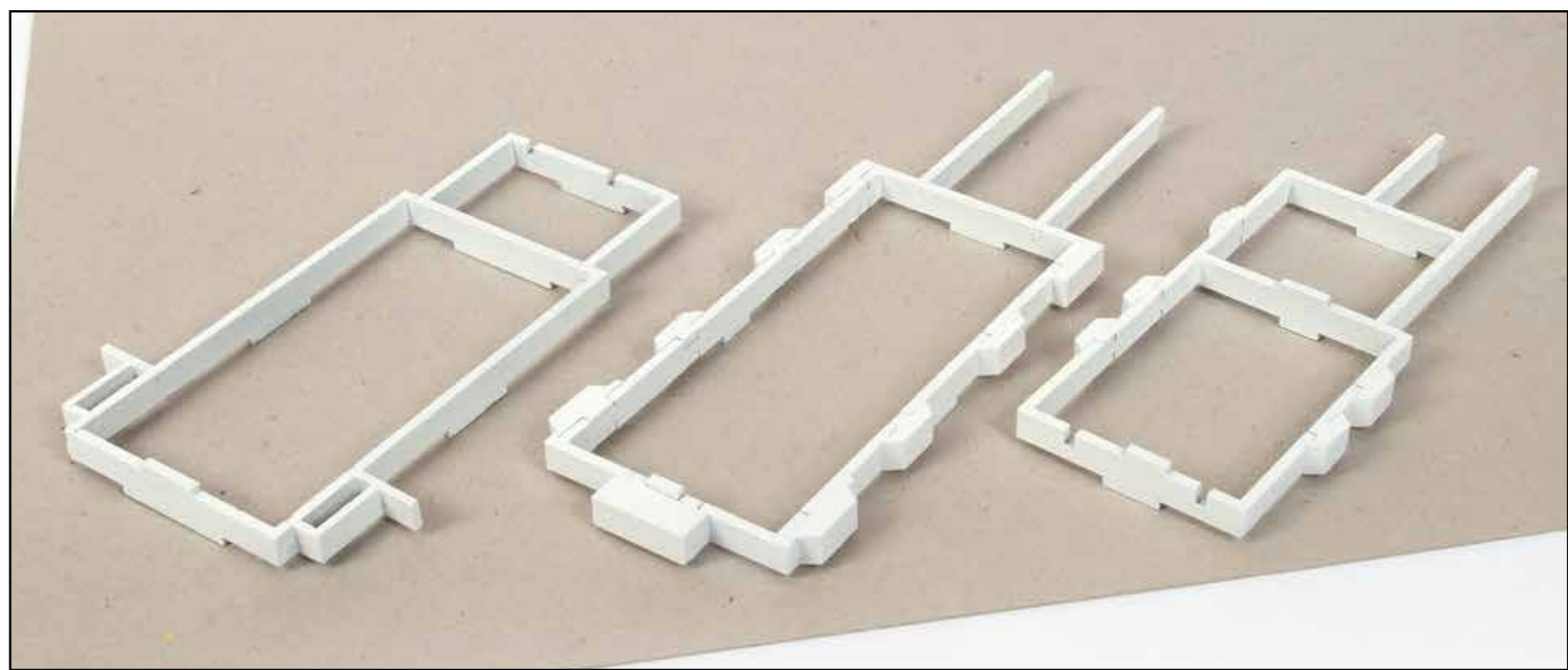
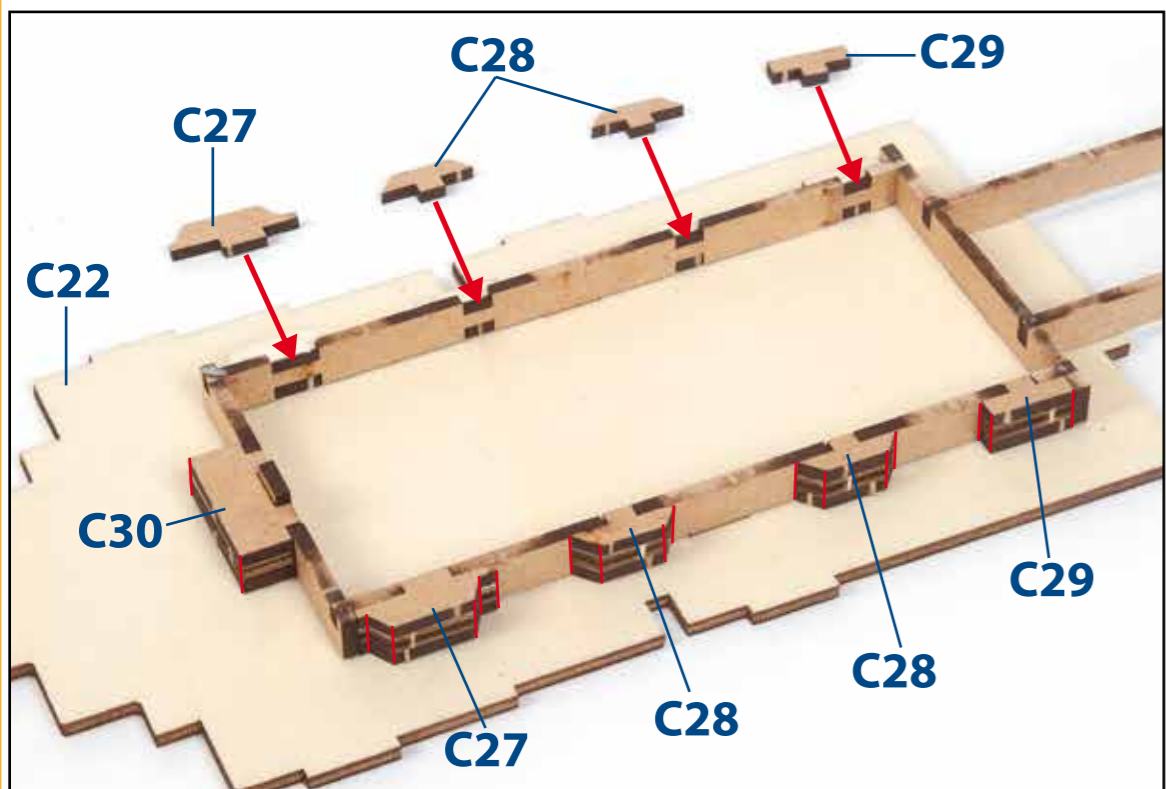
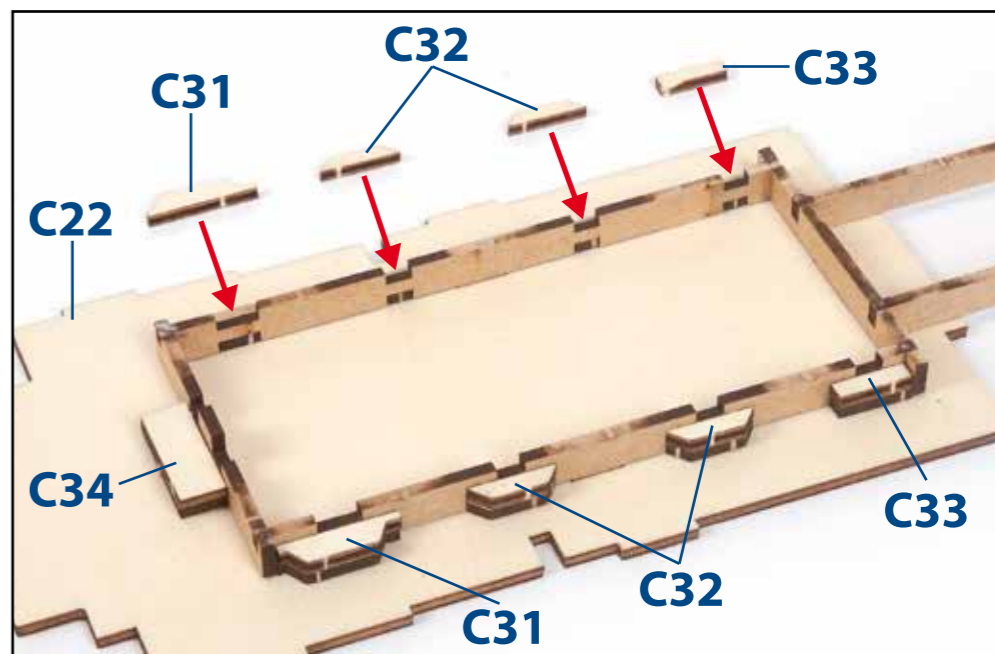
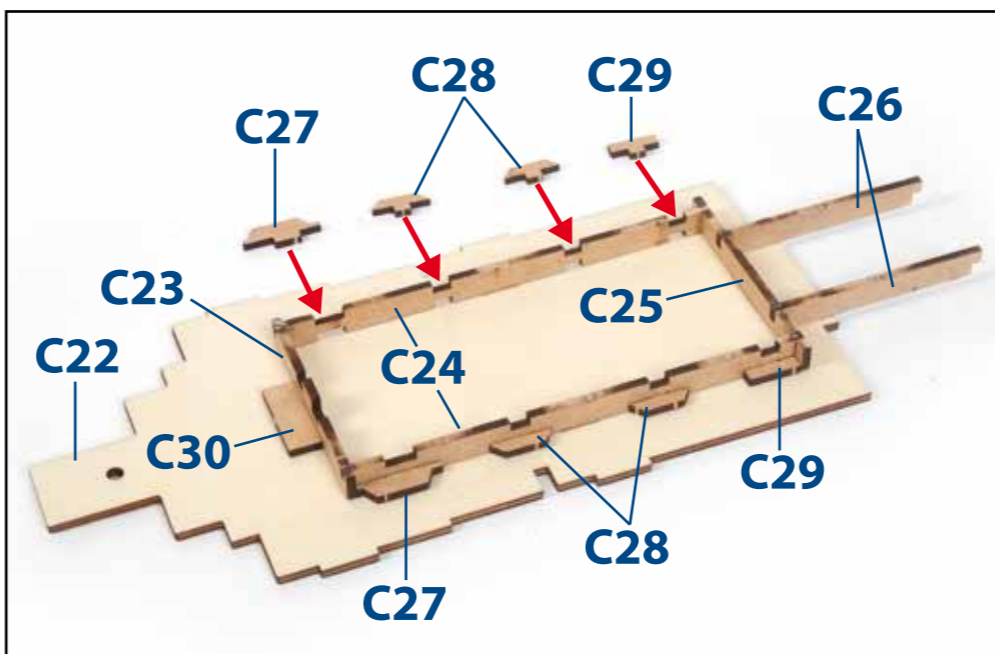
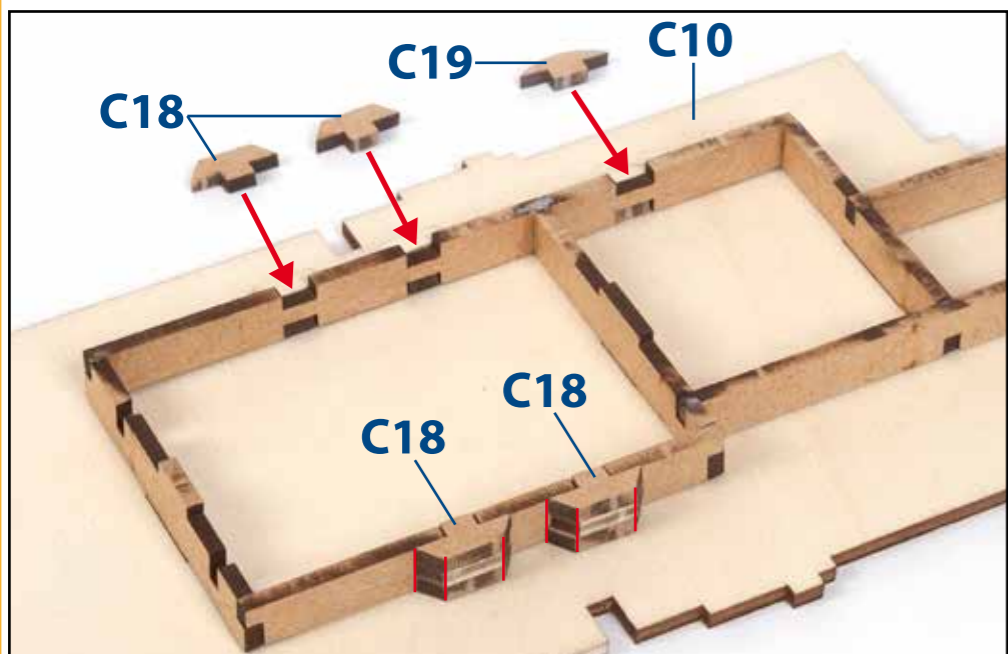
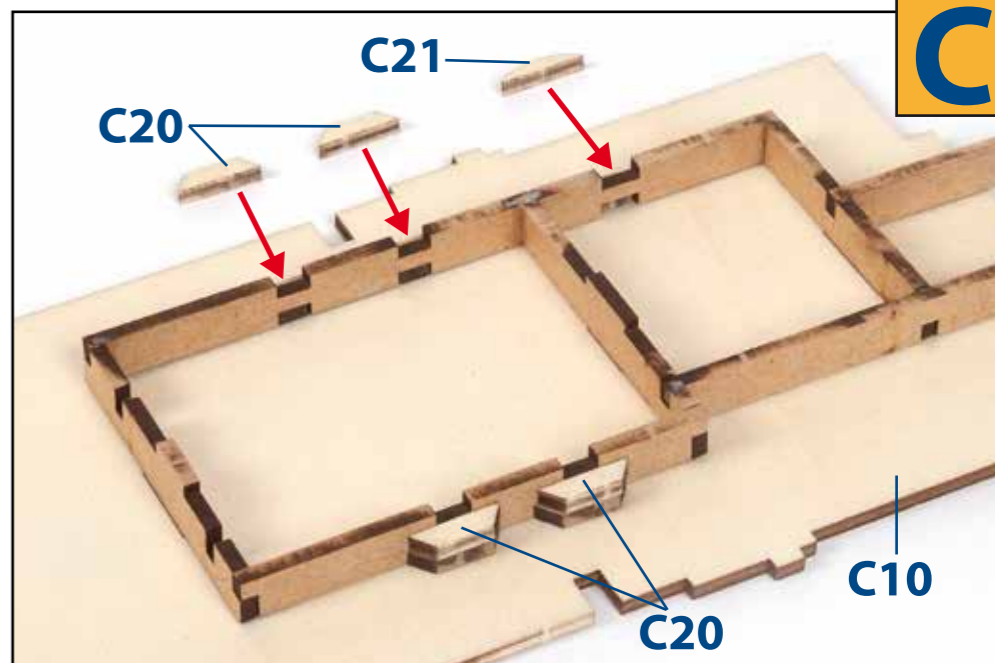
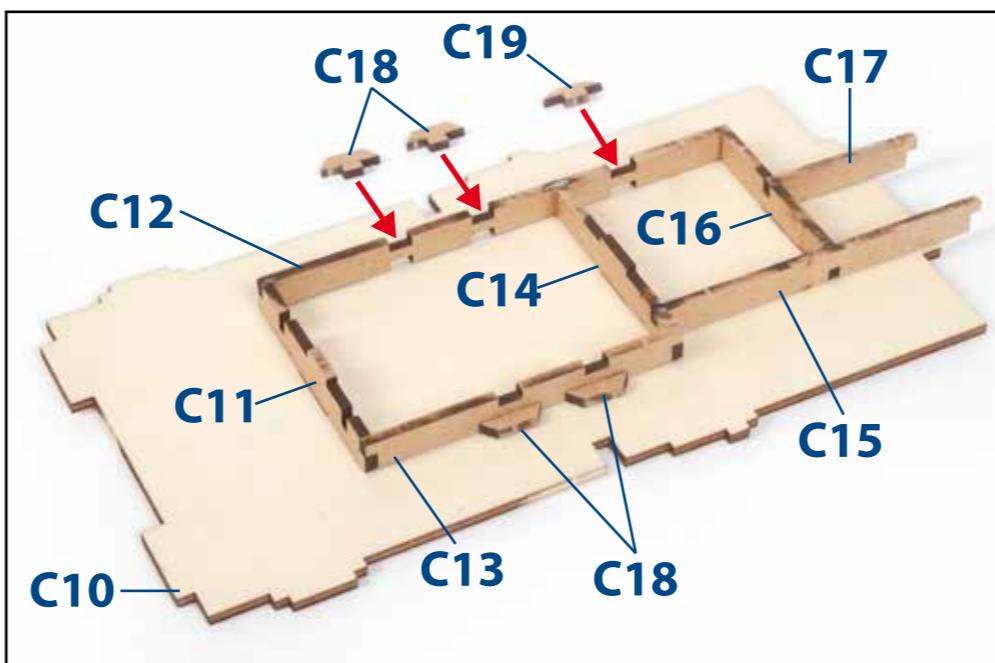
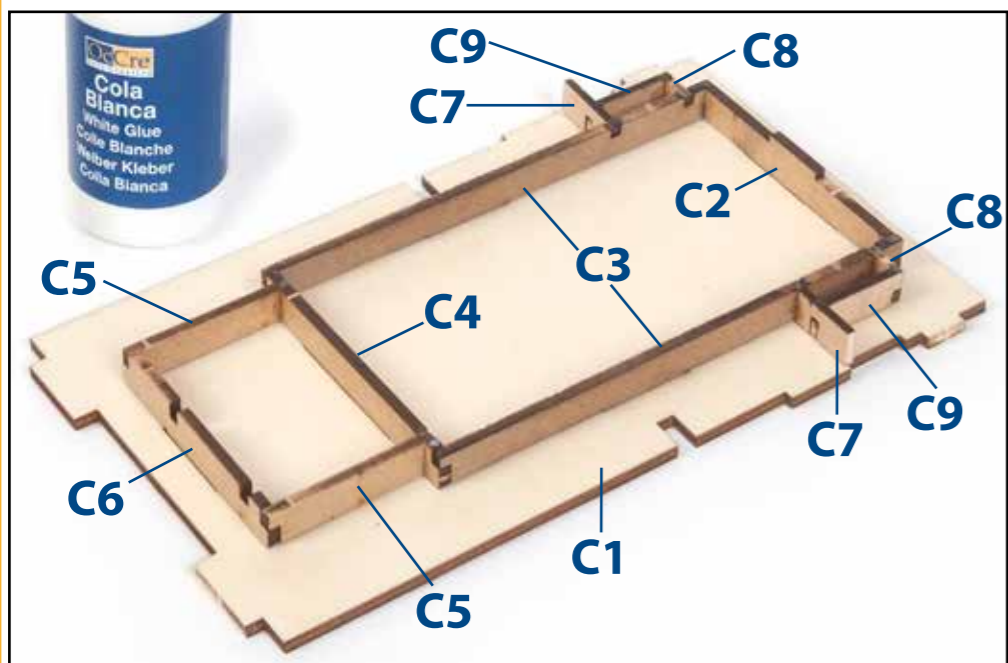

**D**

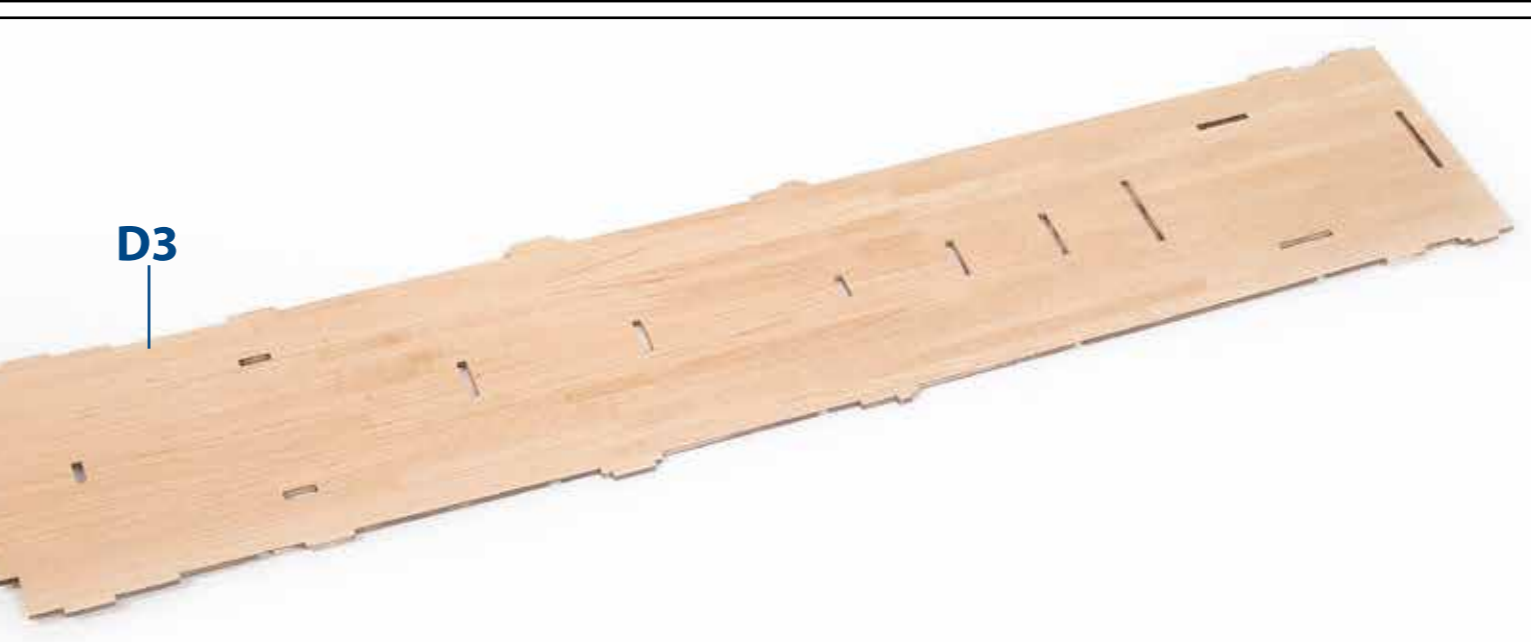
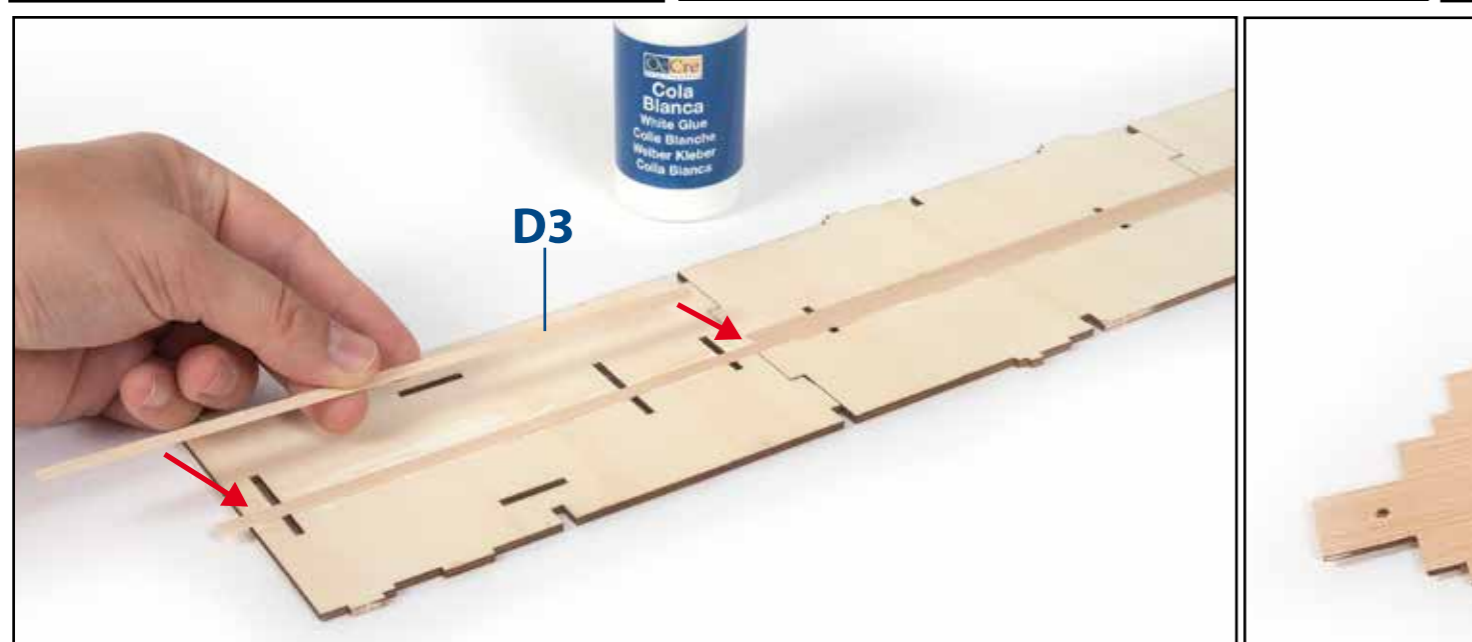
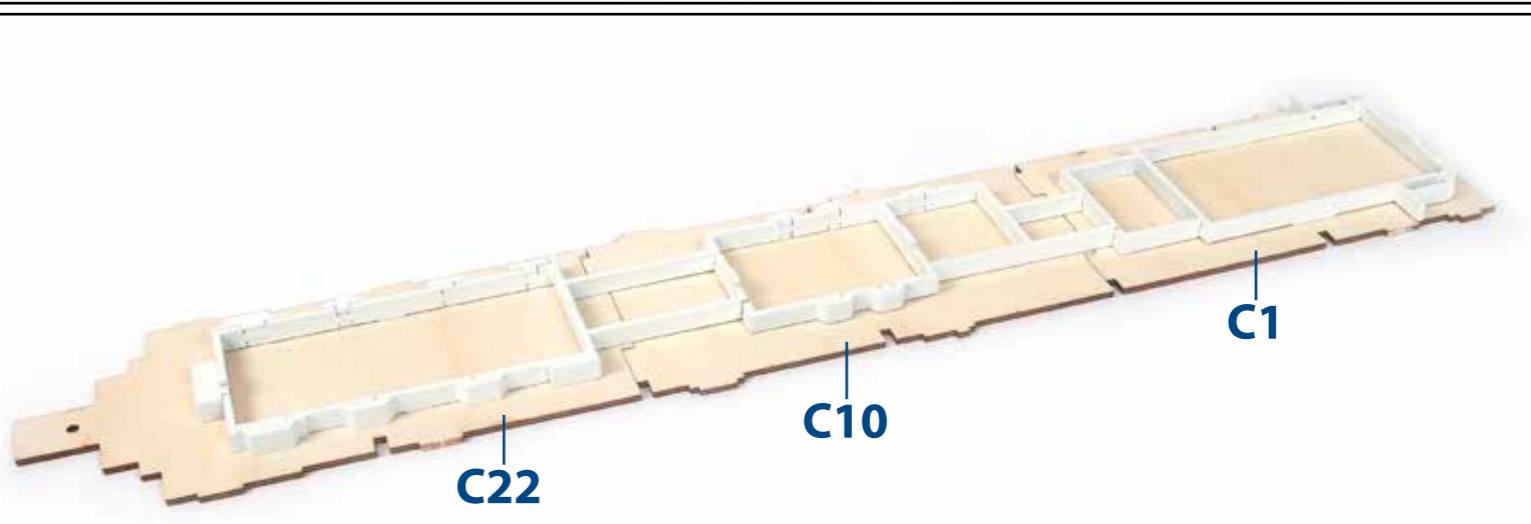
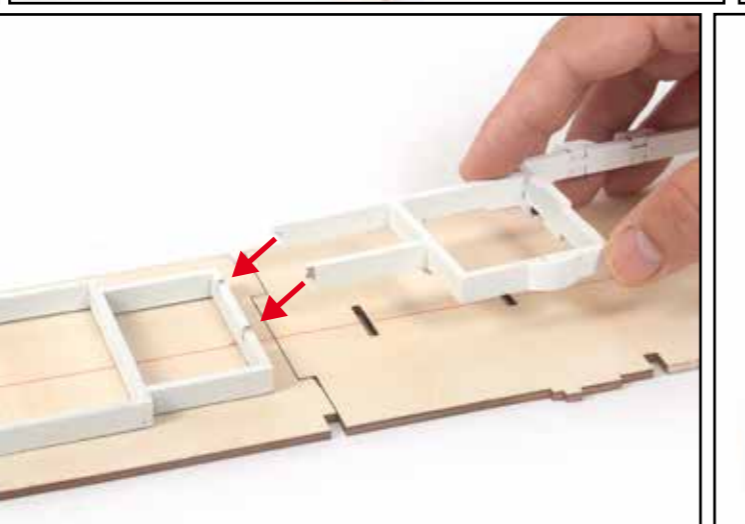
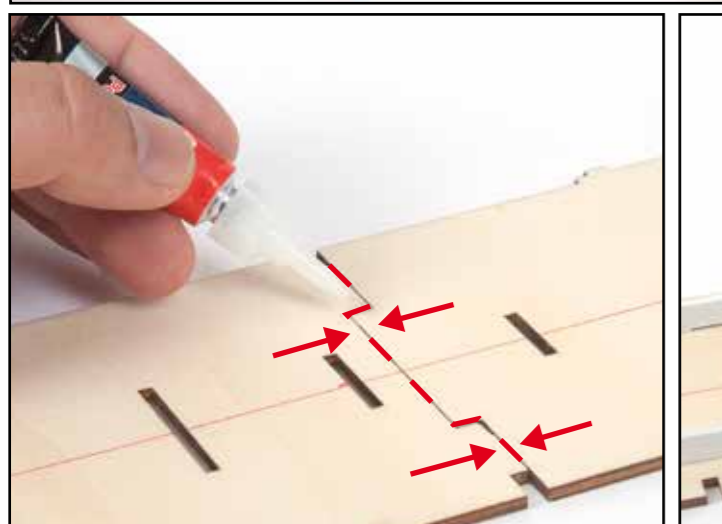
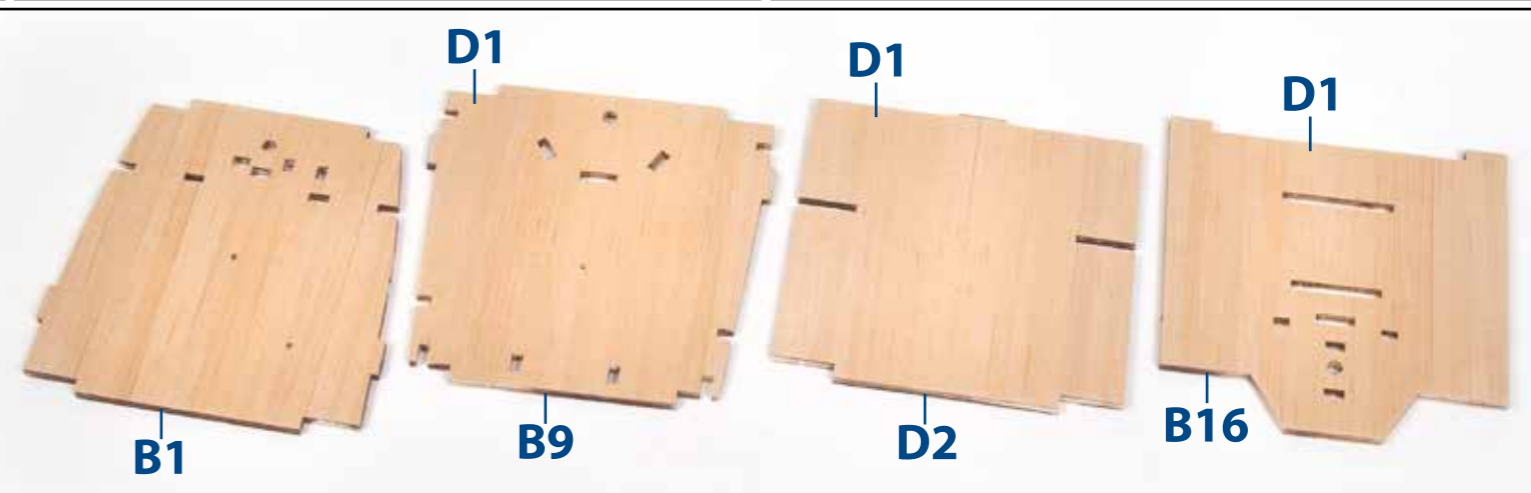
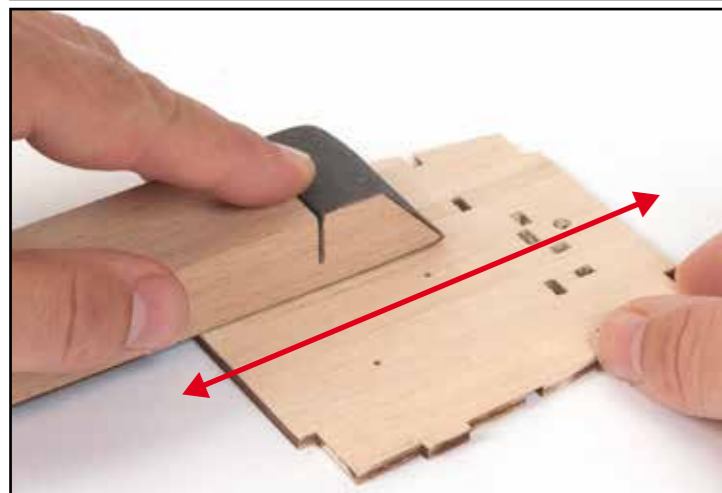
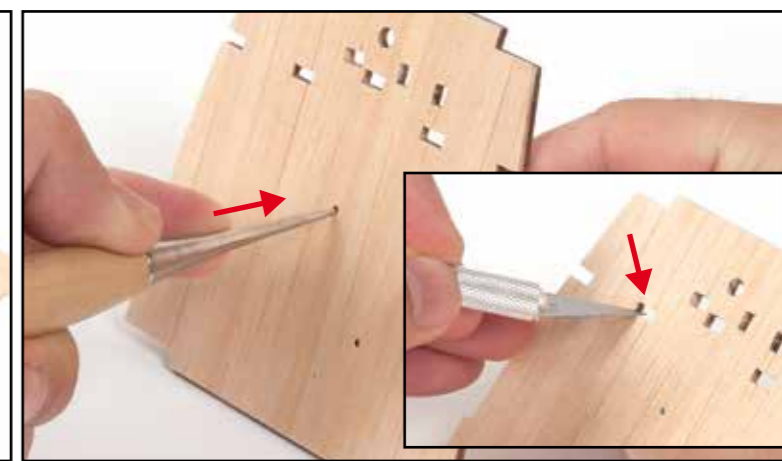
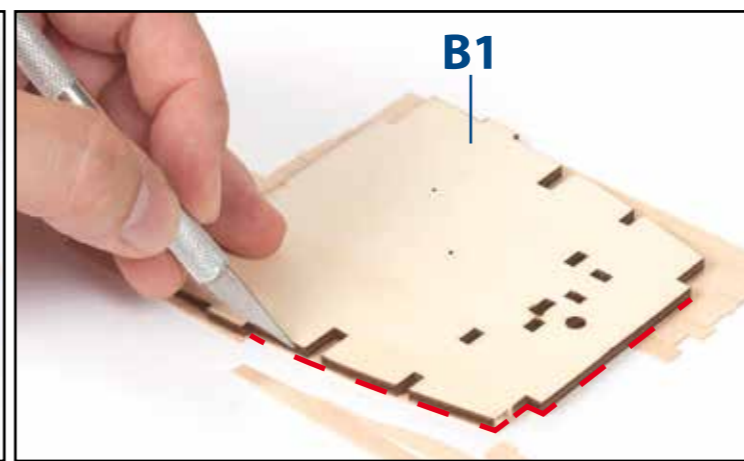
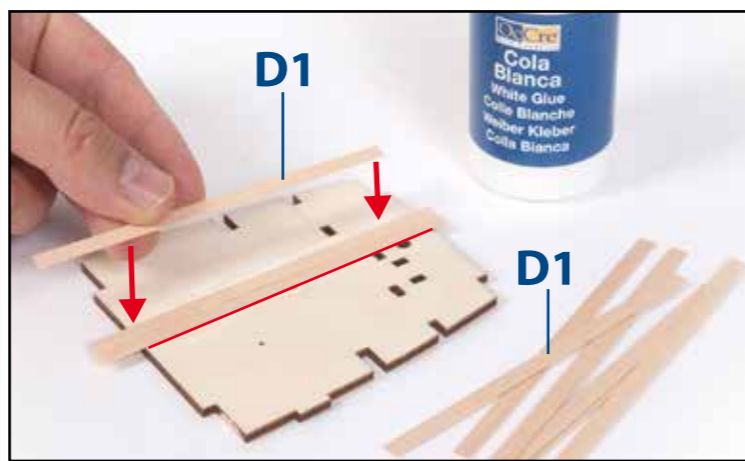
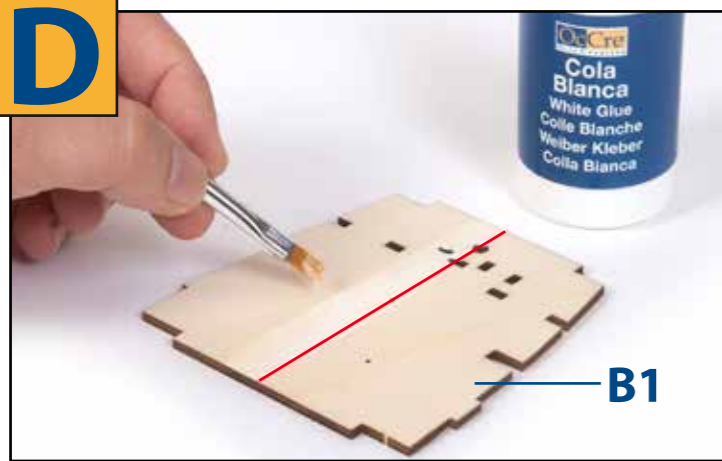



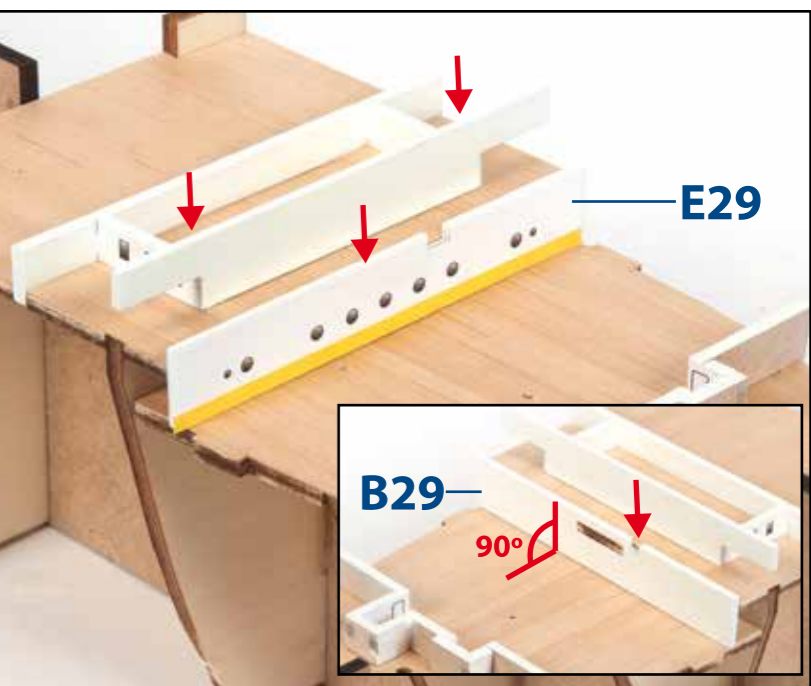
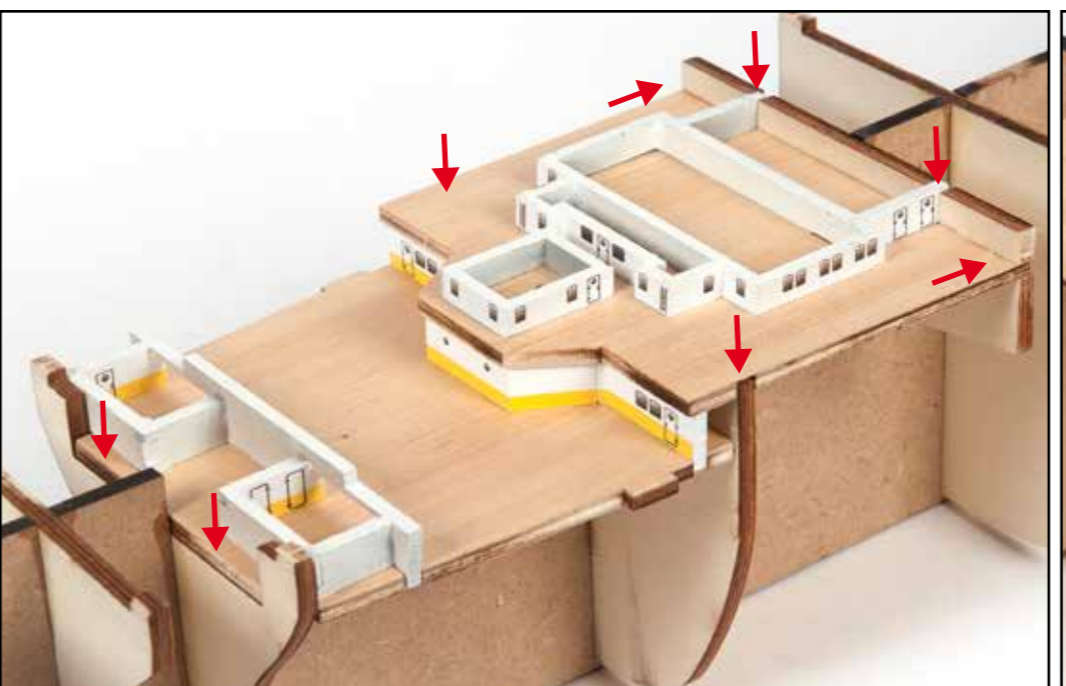
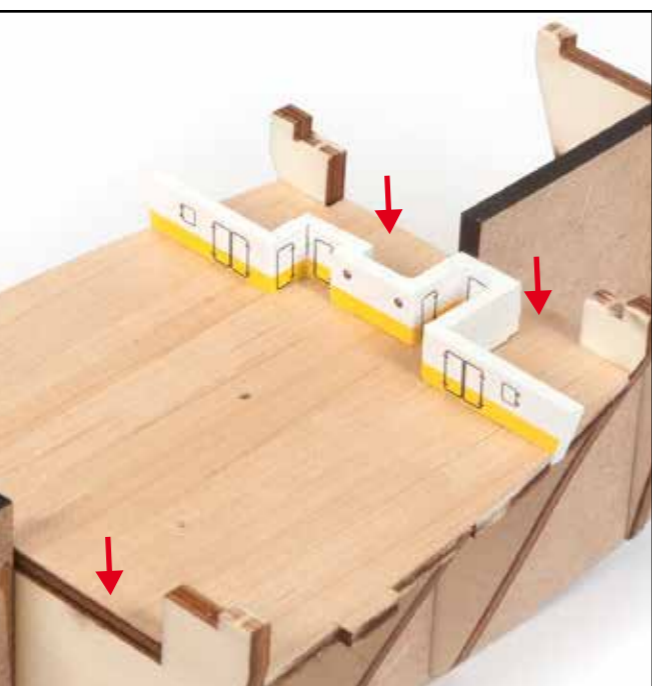
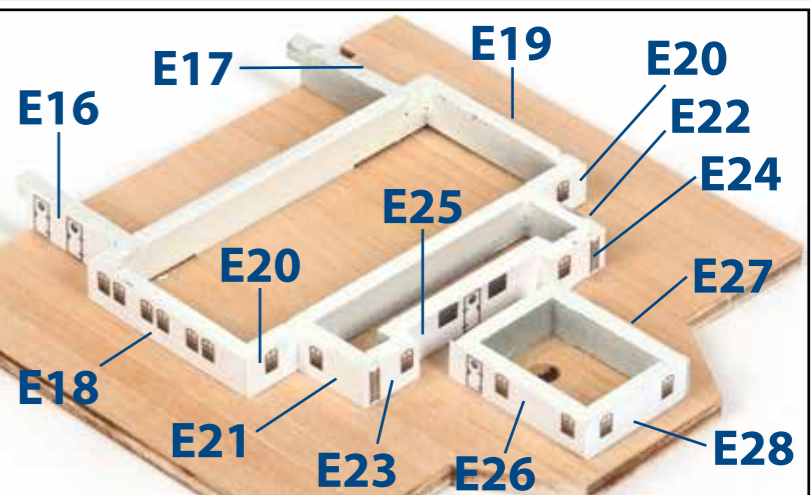
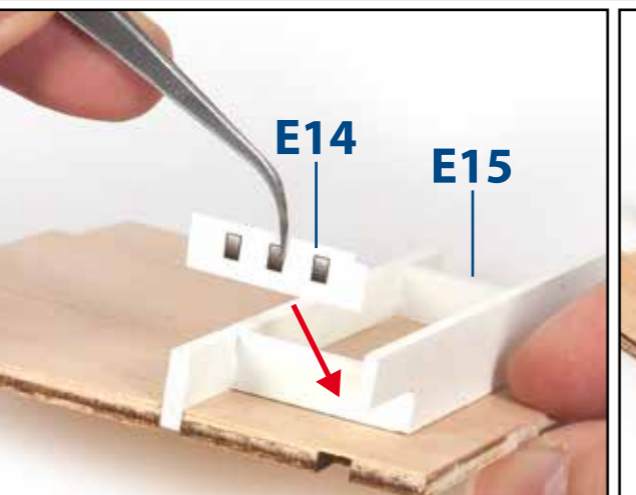
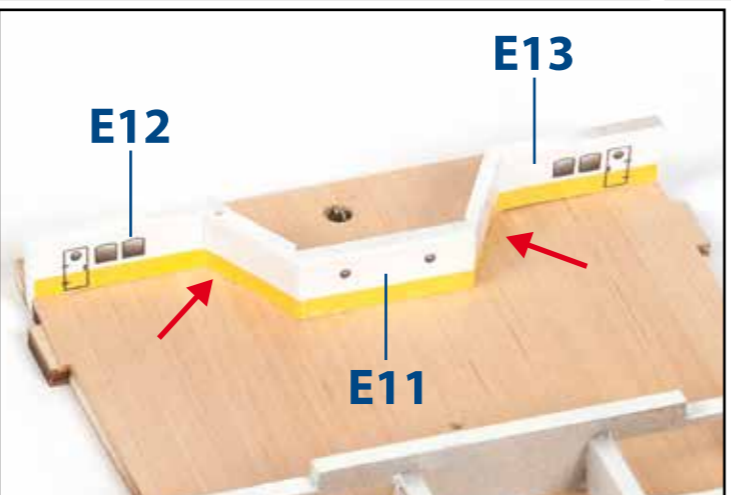
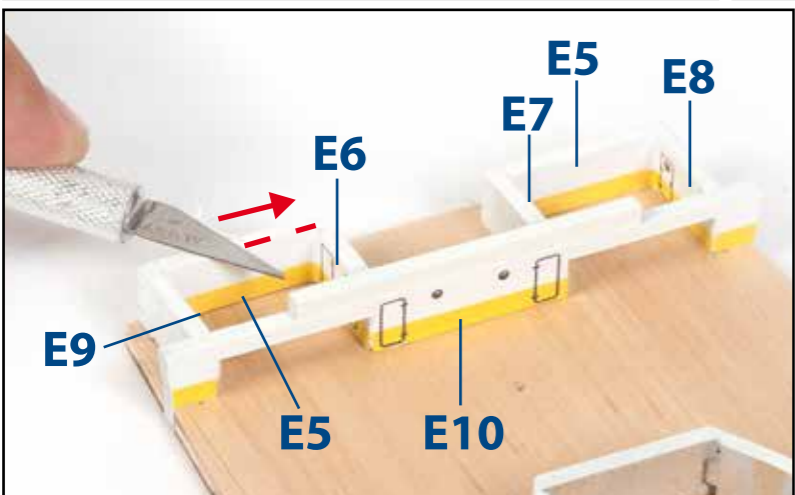
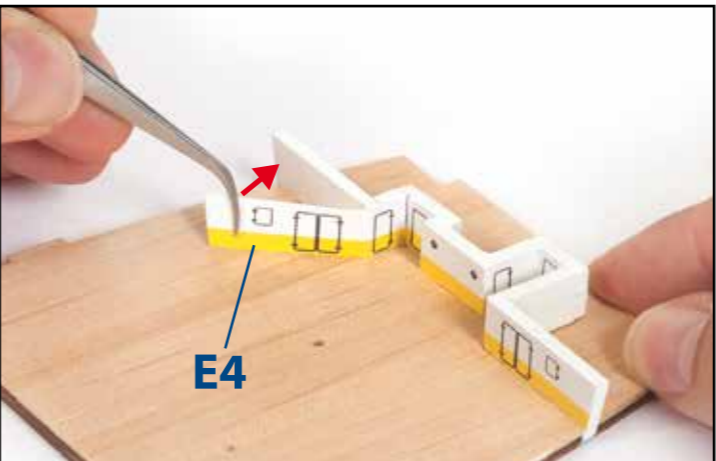
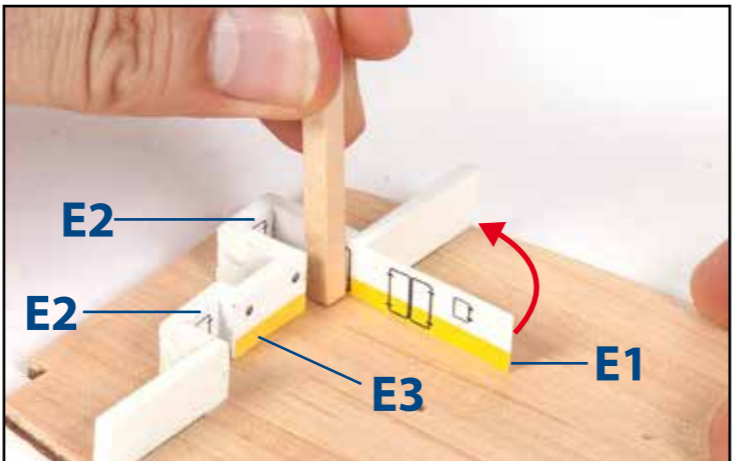
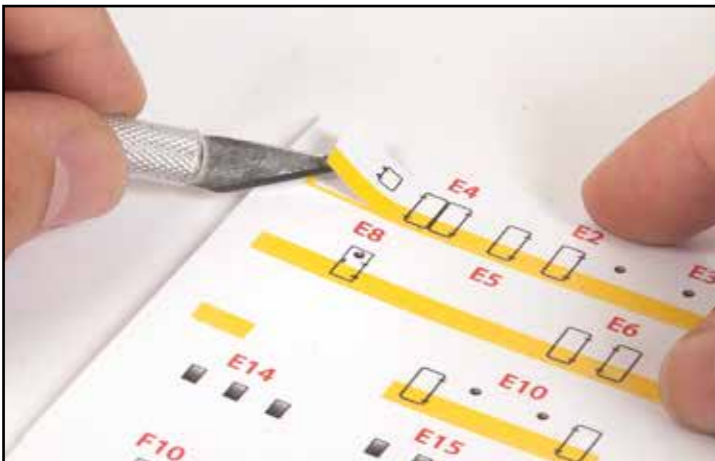
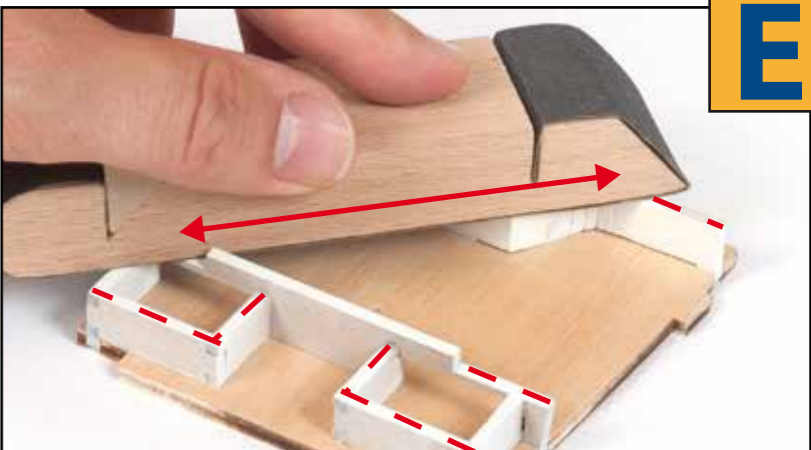
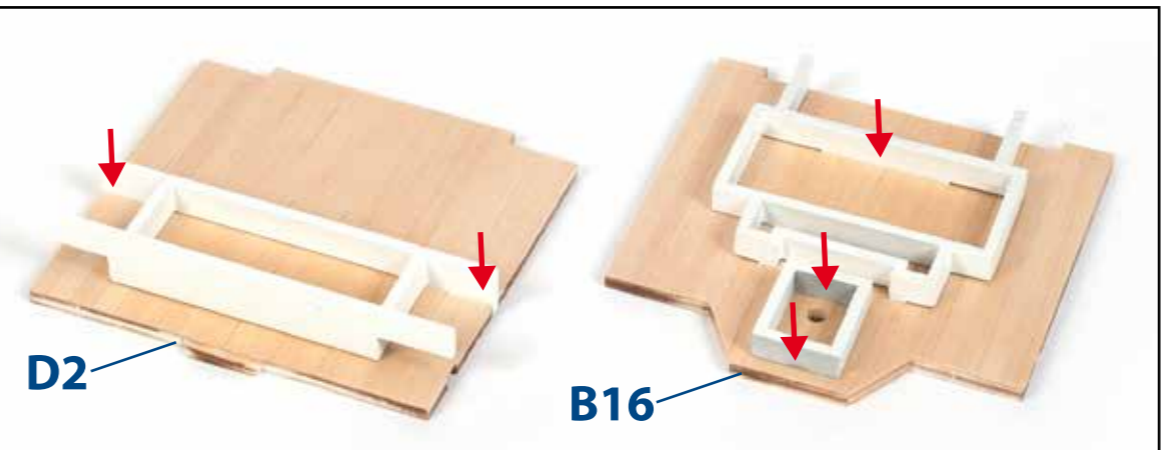
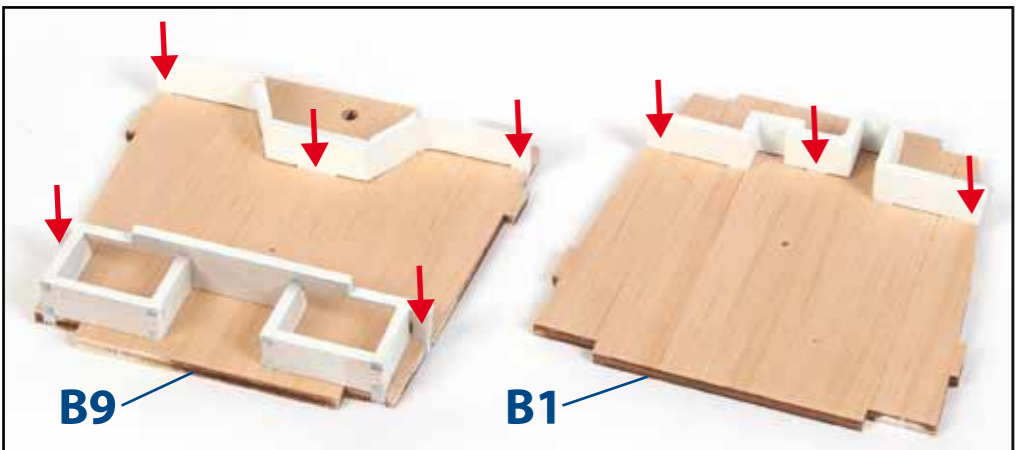

**F**

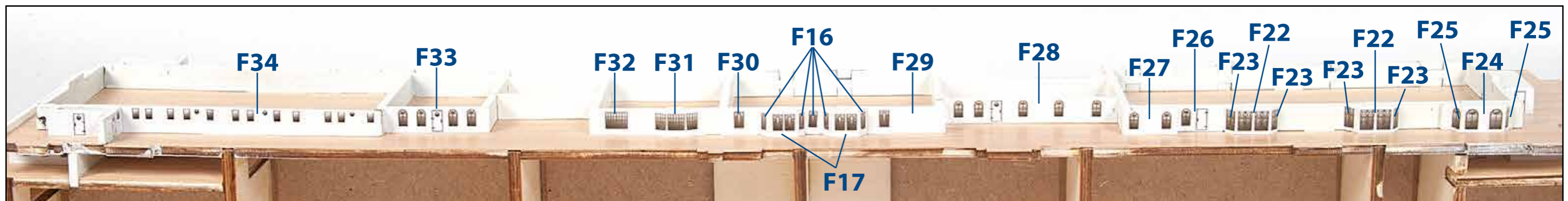
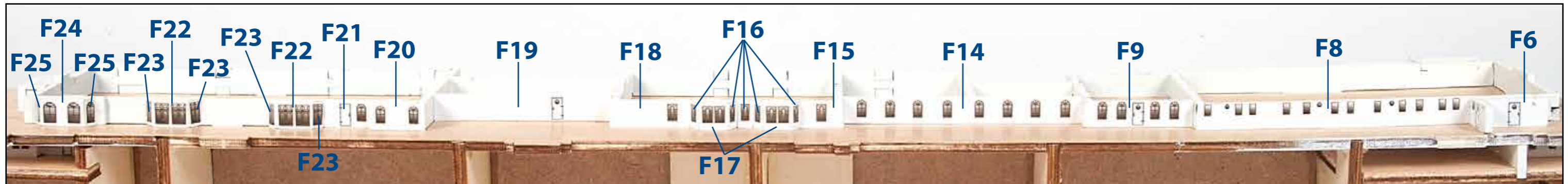
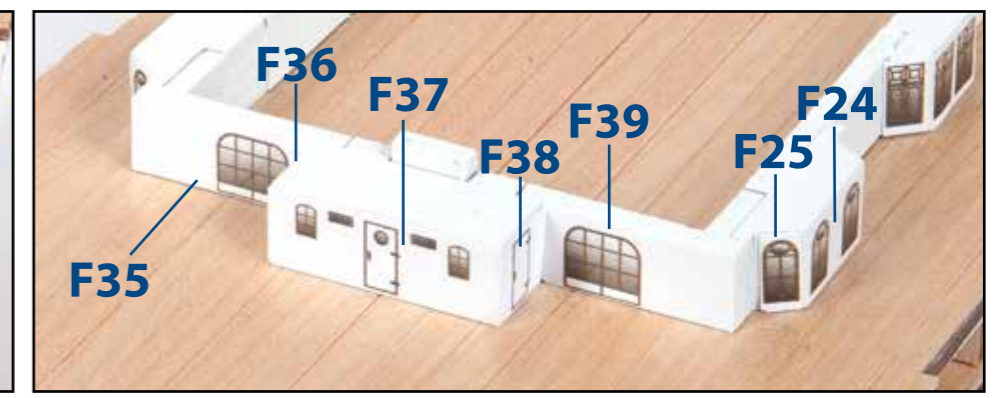
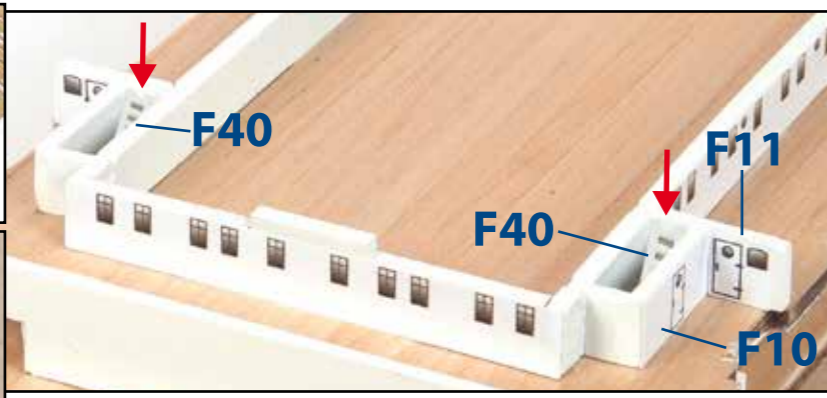
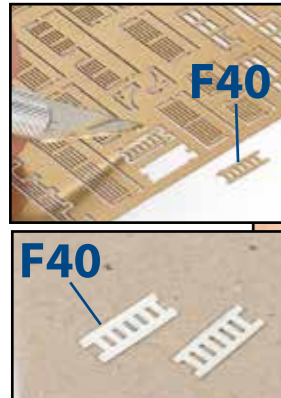
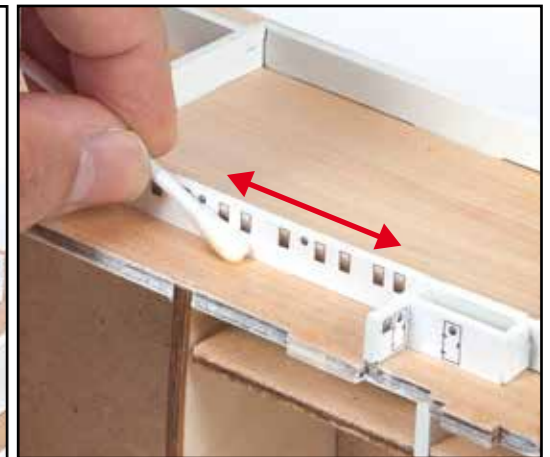
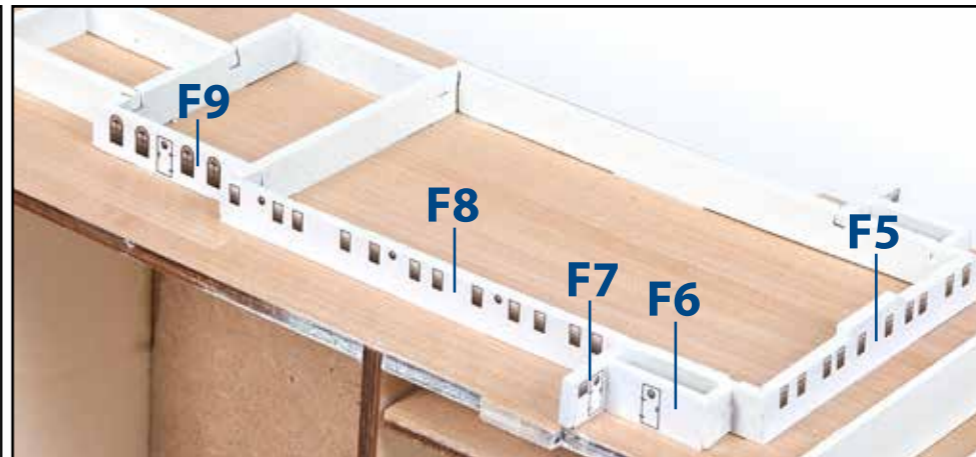
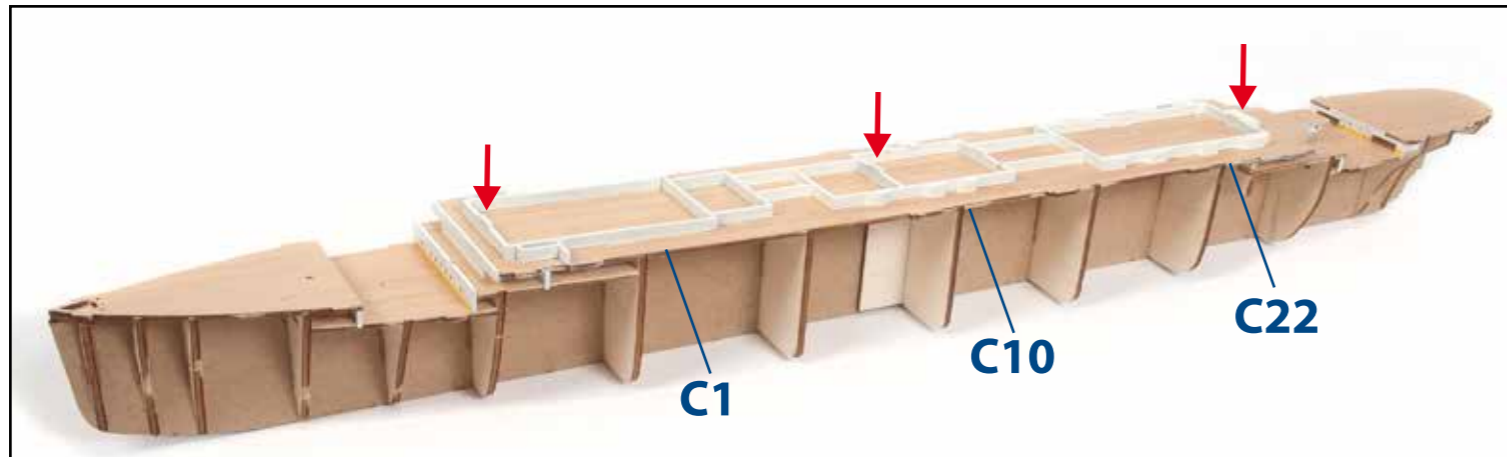
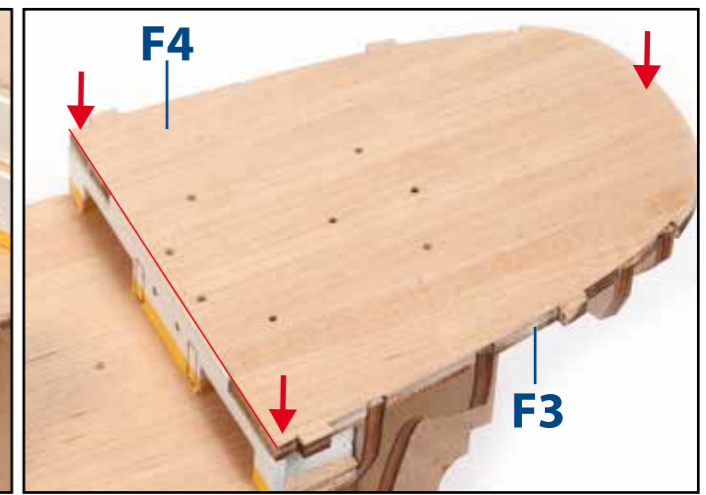
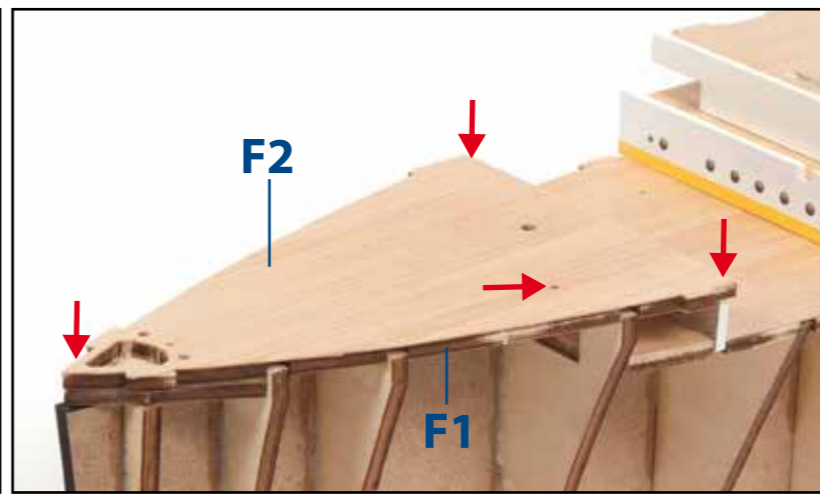
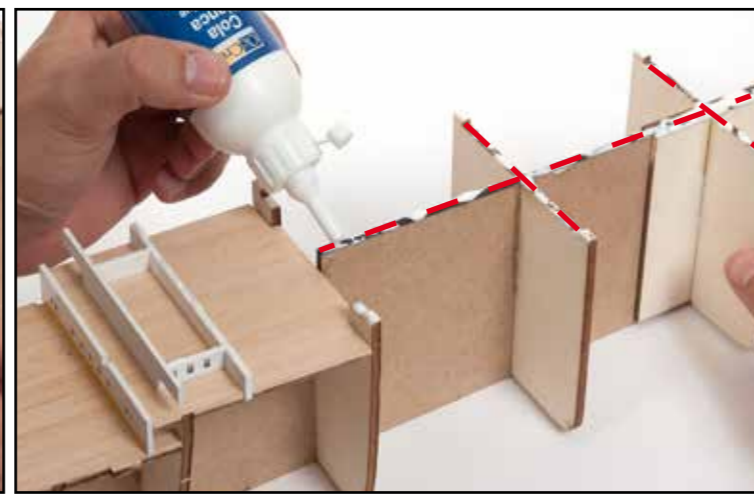
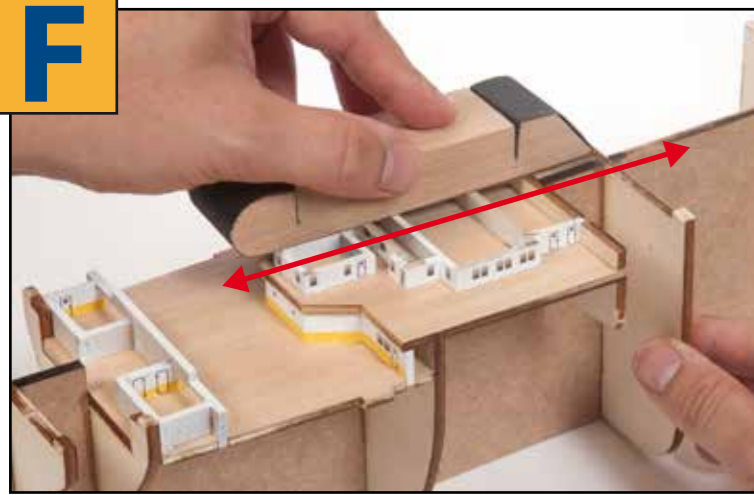

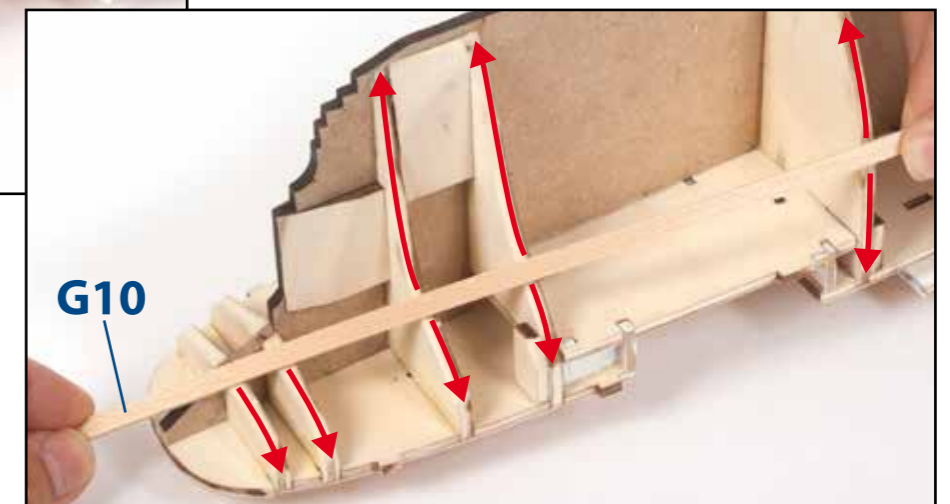
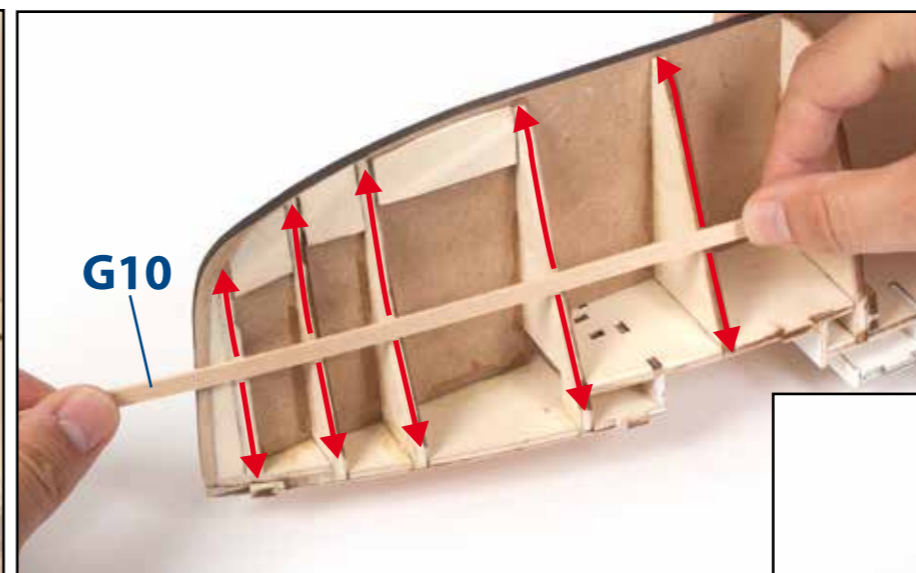
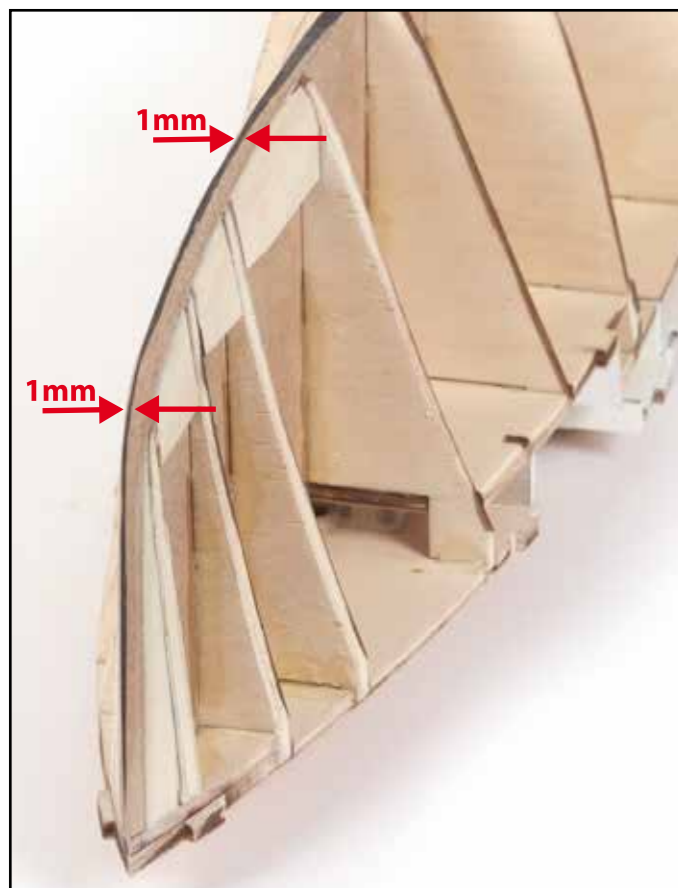
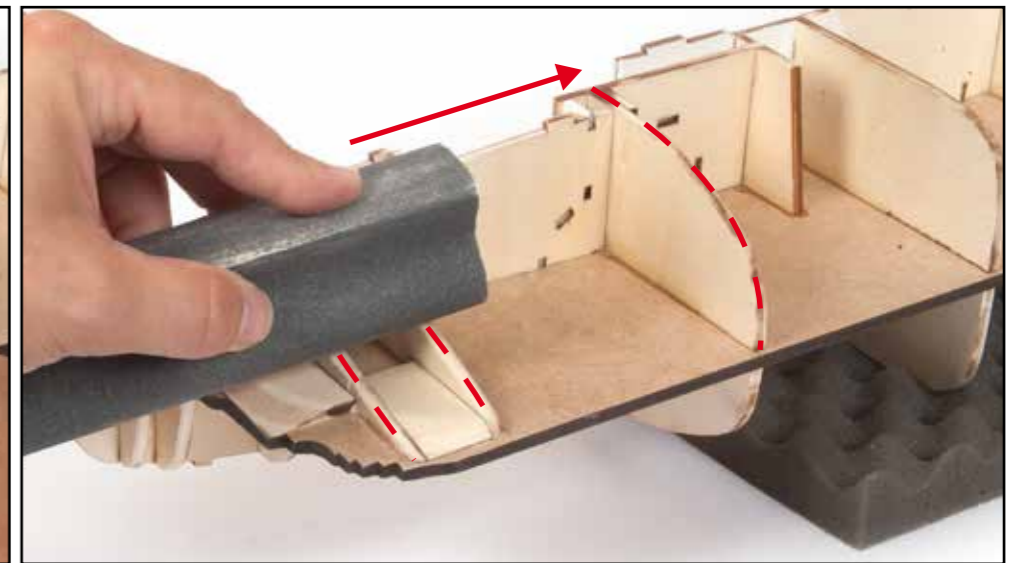
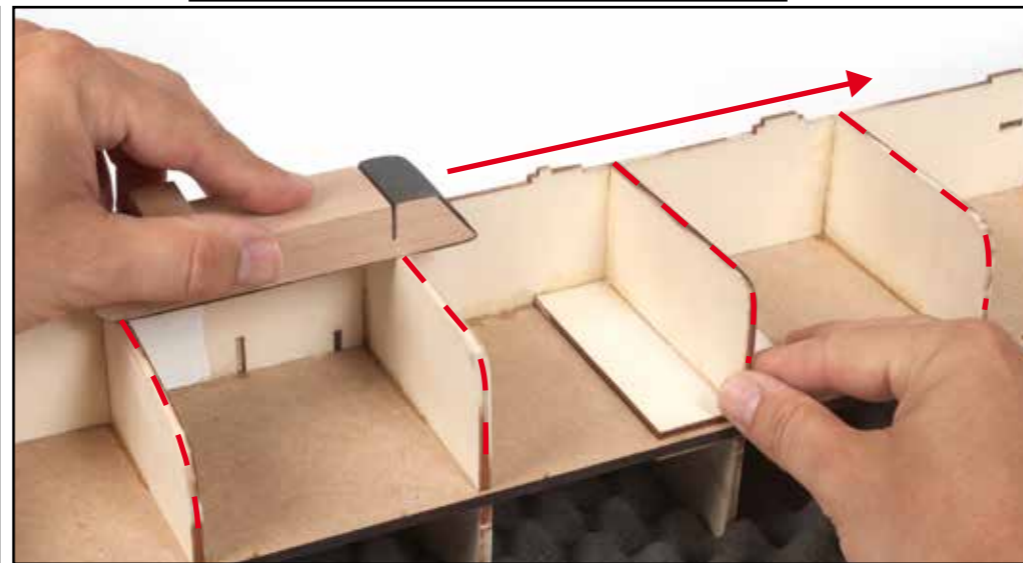
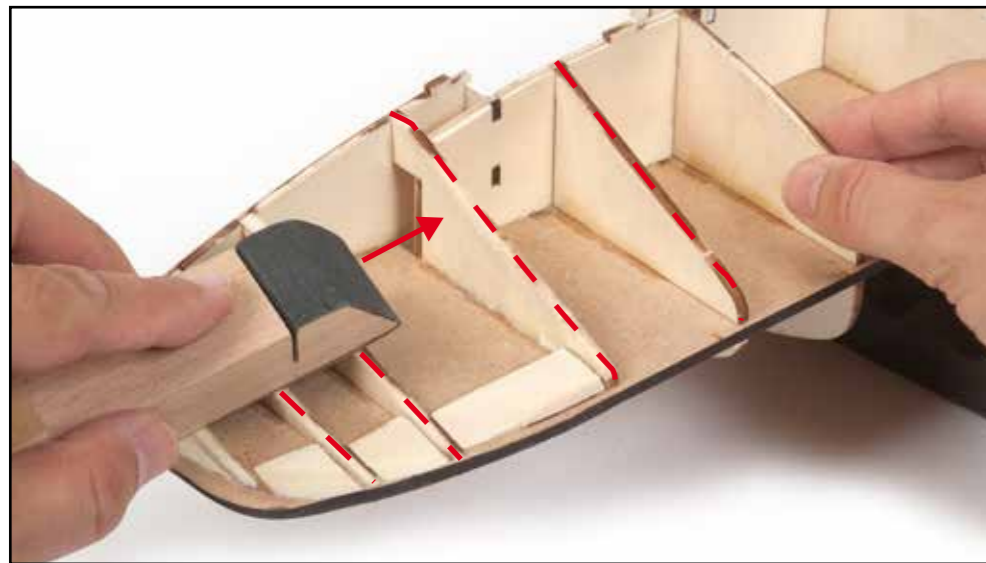
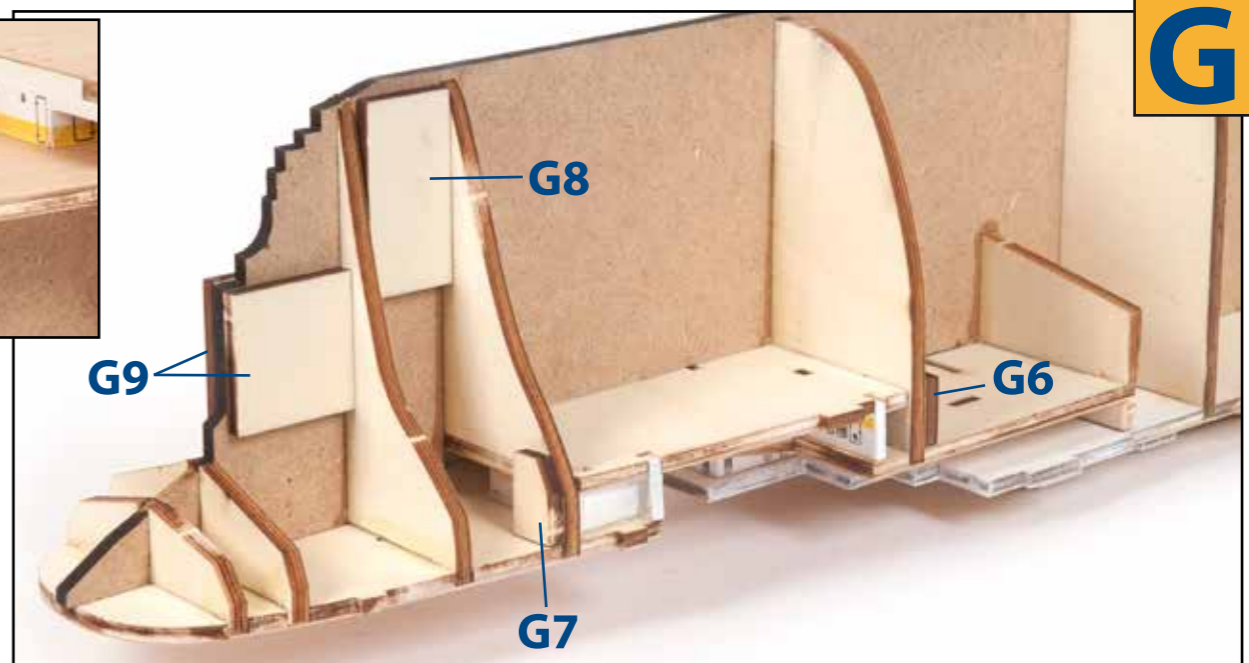
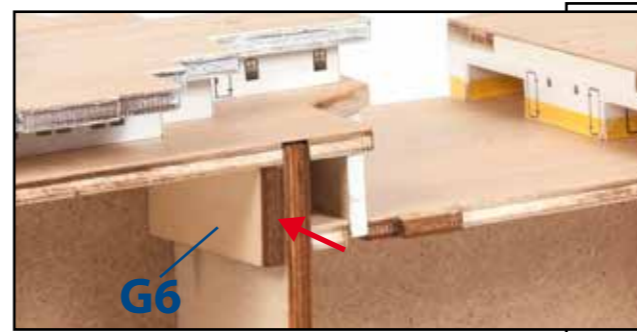
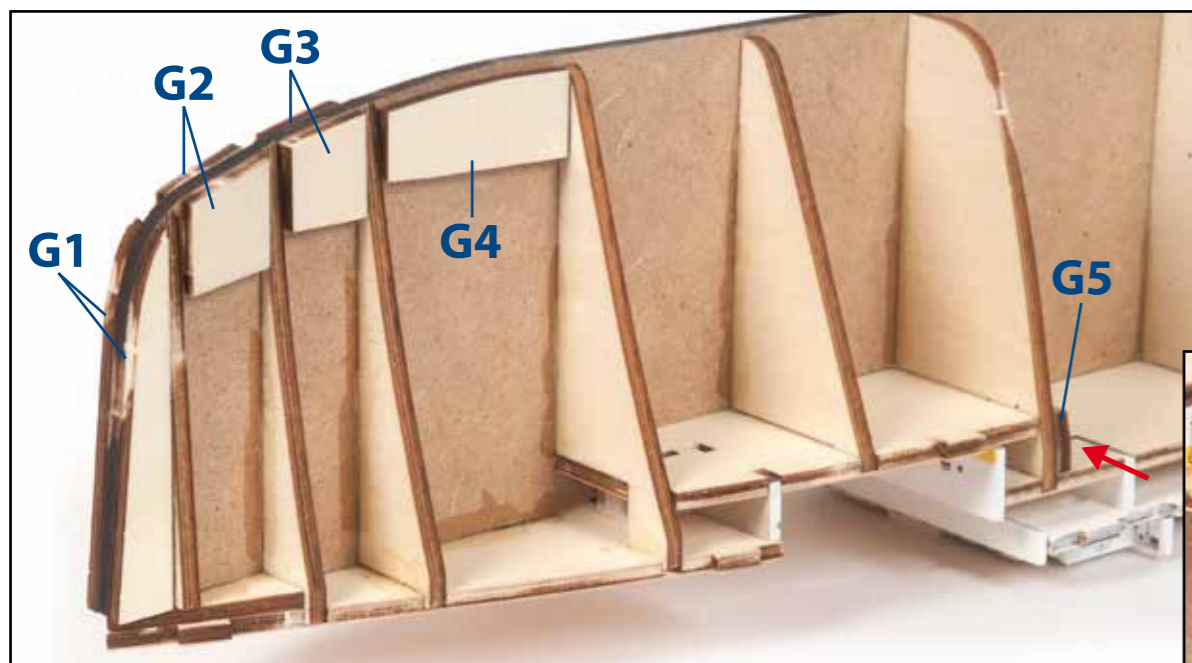

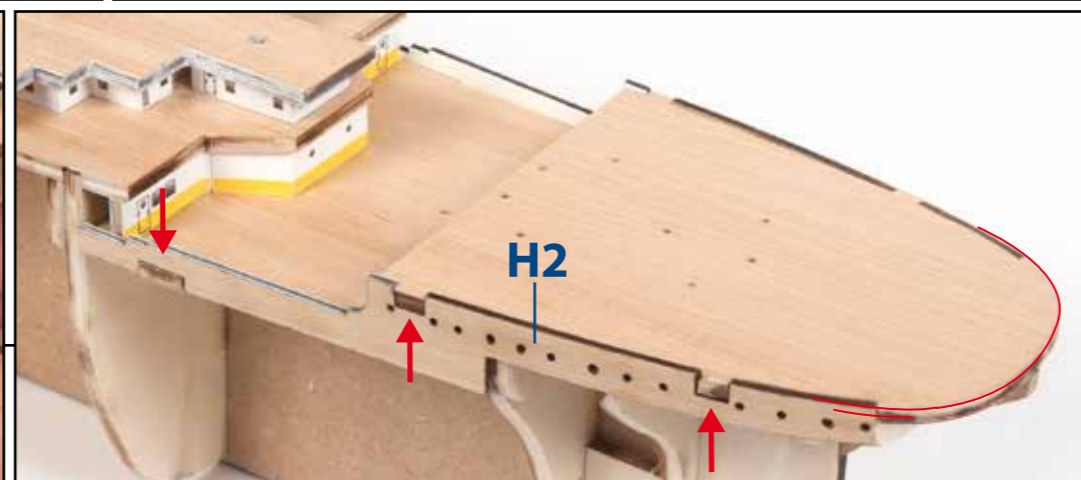
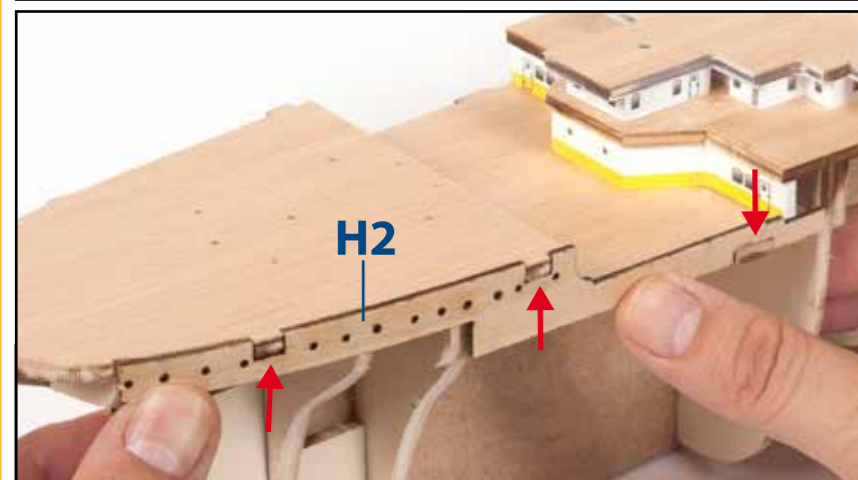
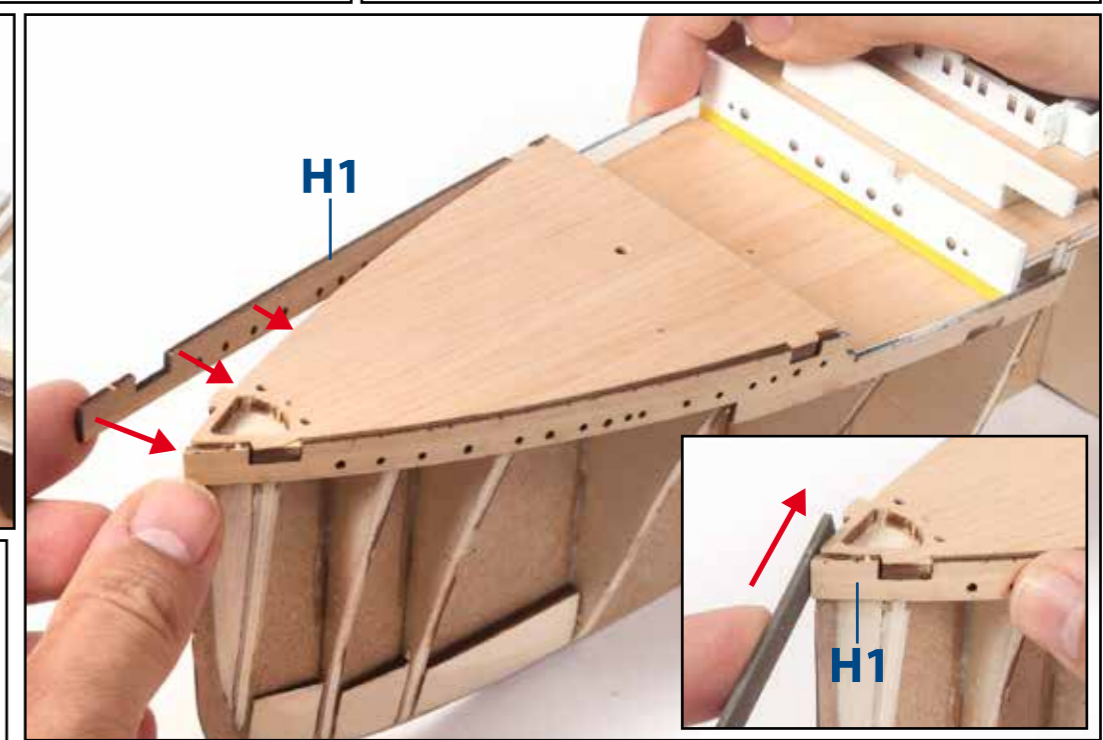
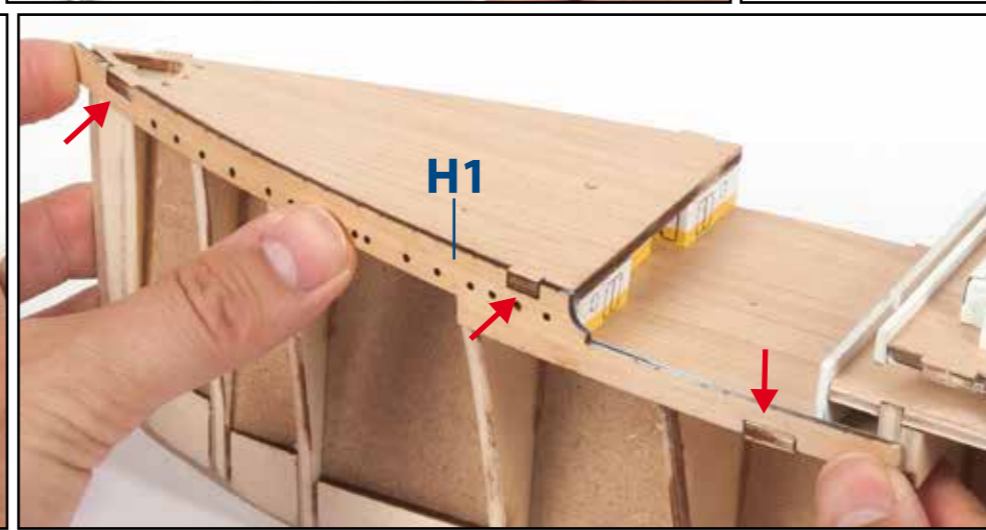
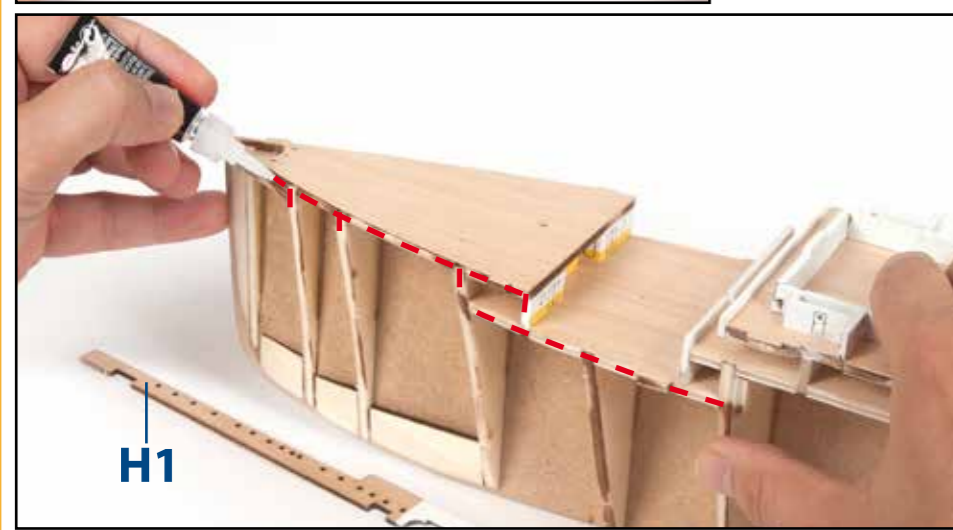
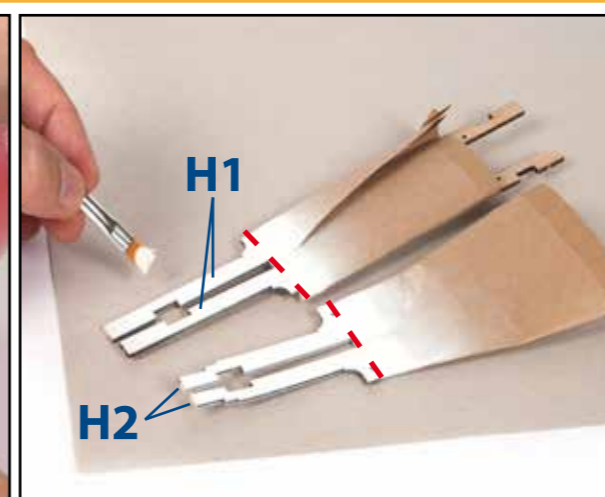
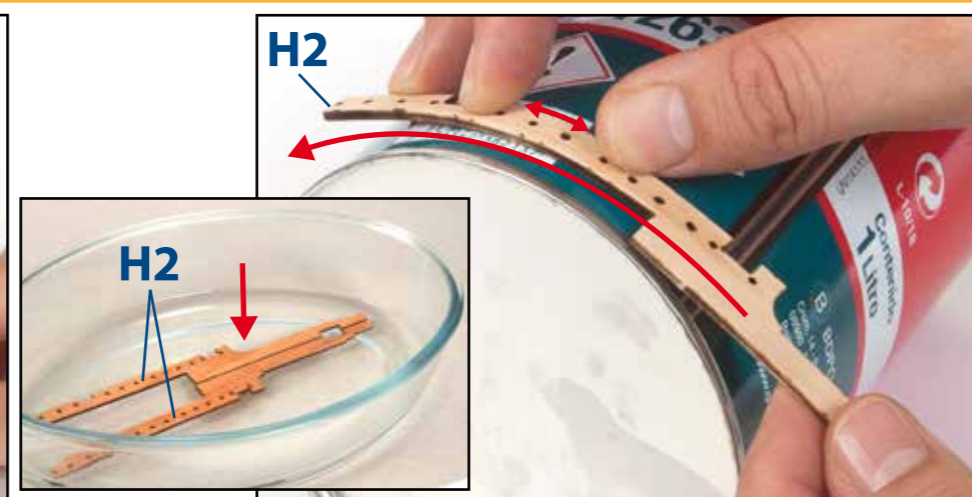
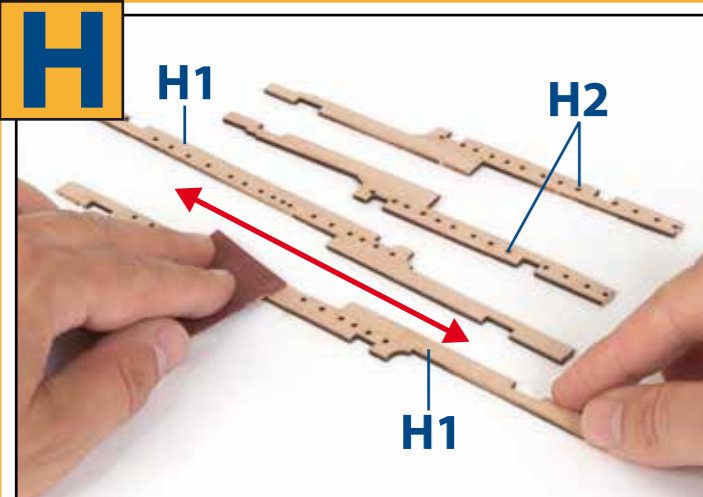
**H**

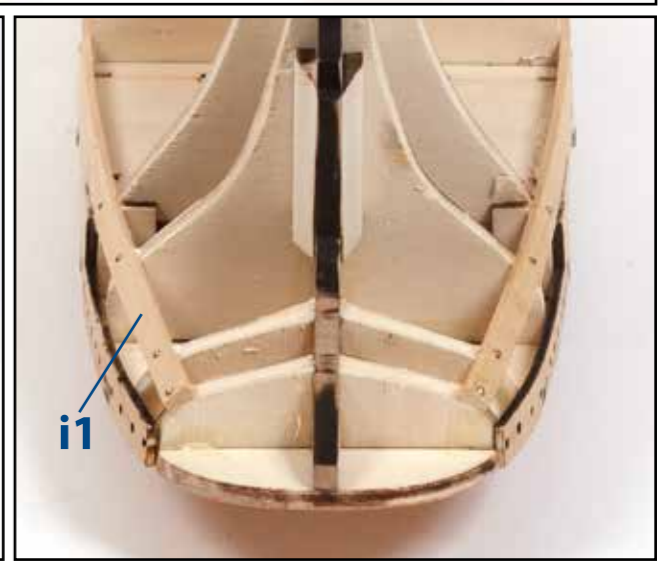
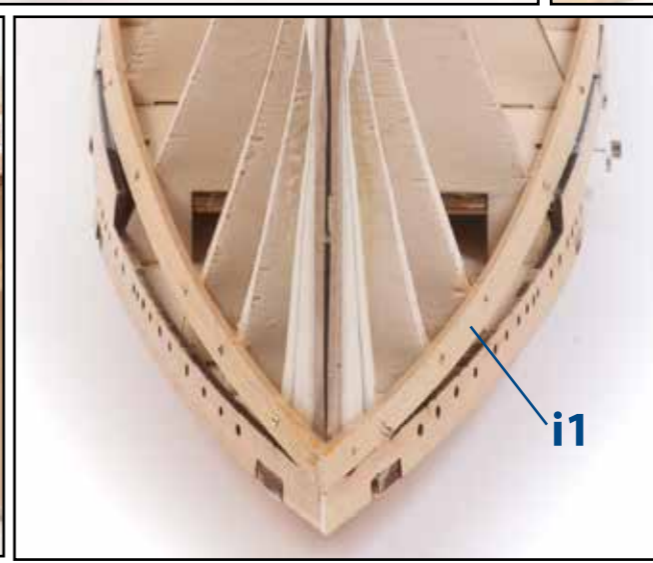
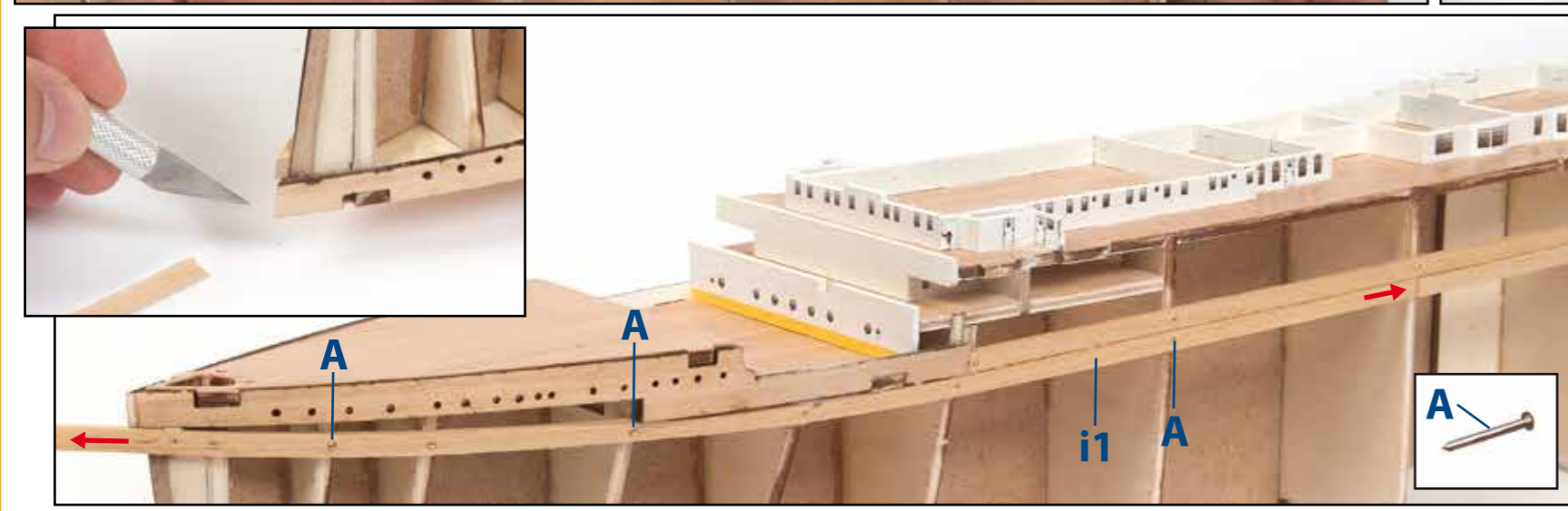
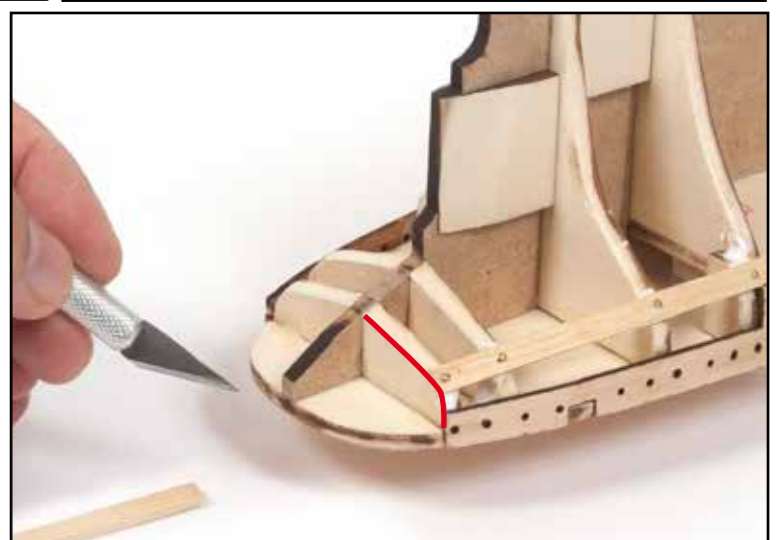
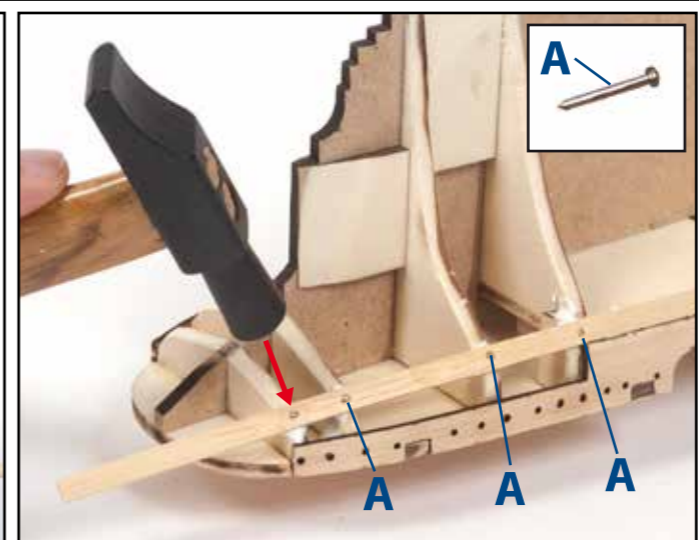
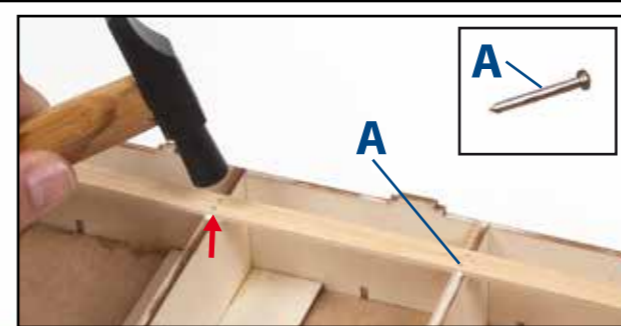
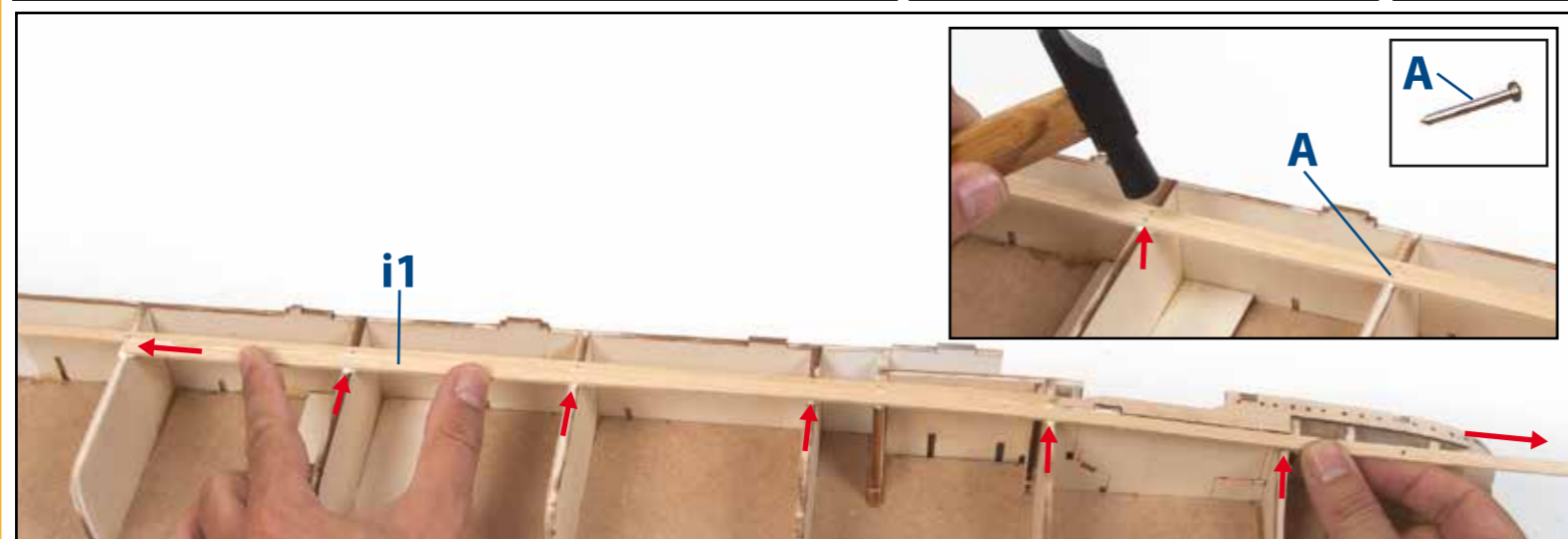
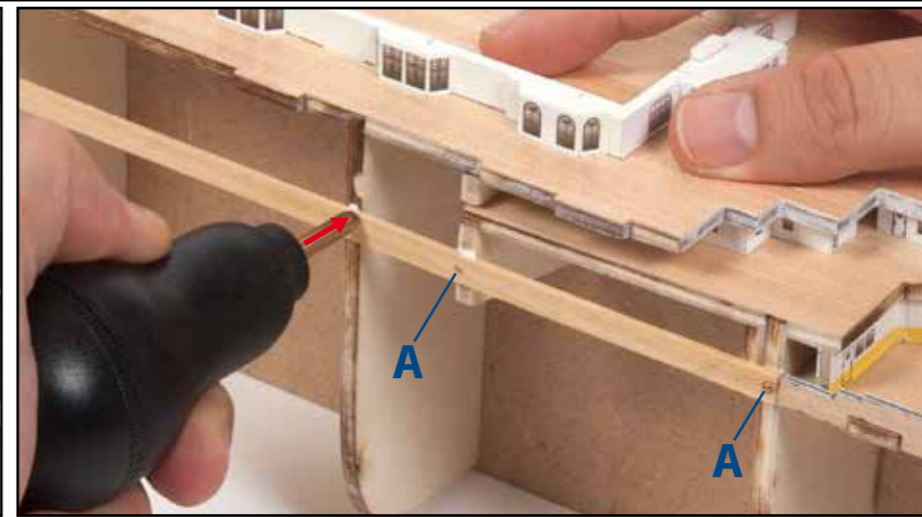
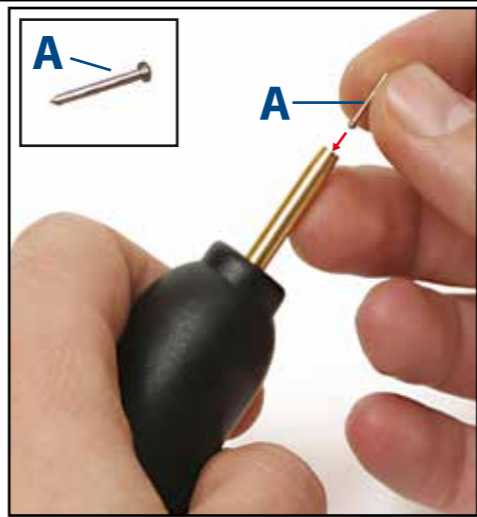
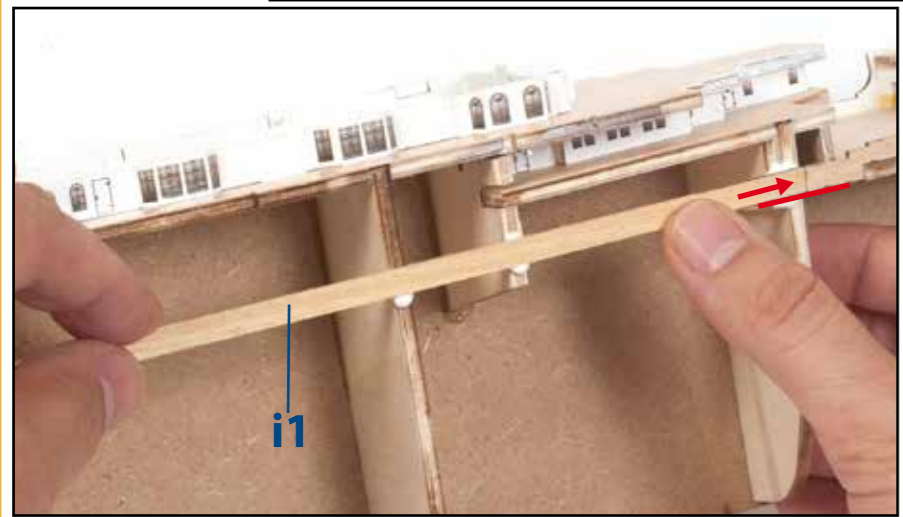
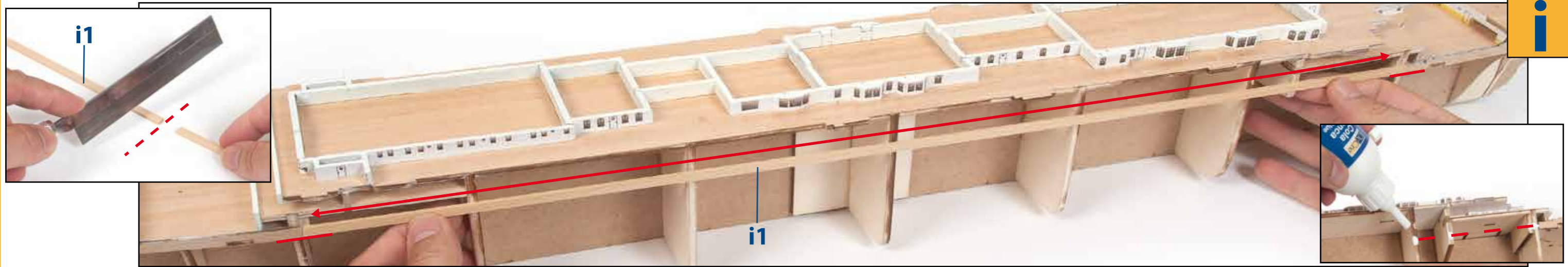

J

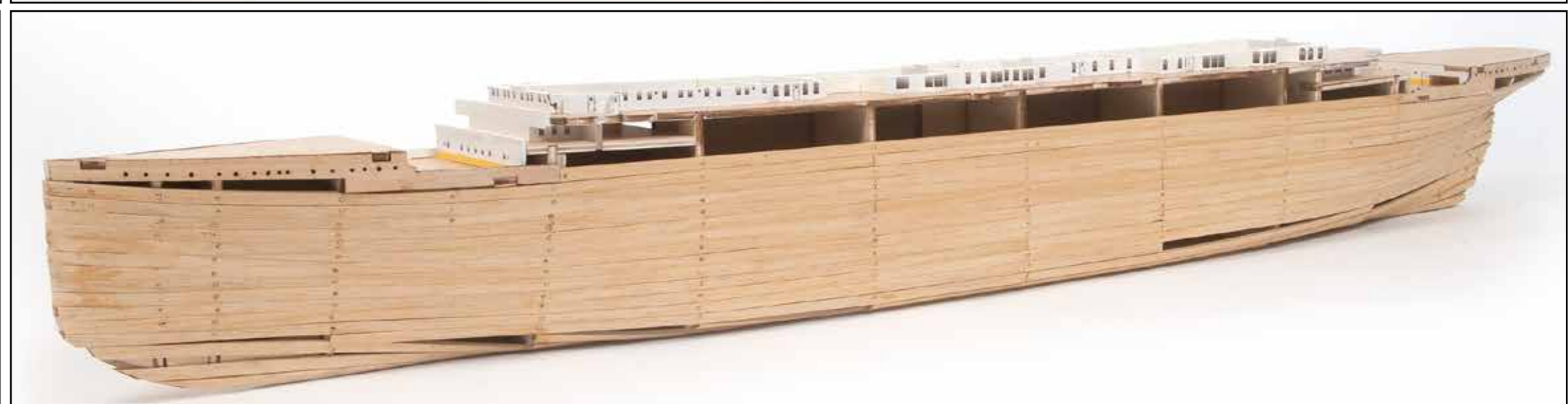
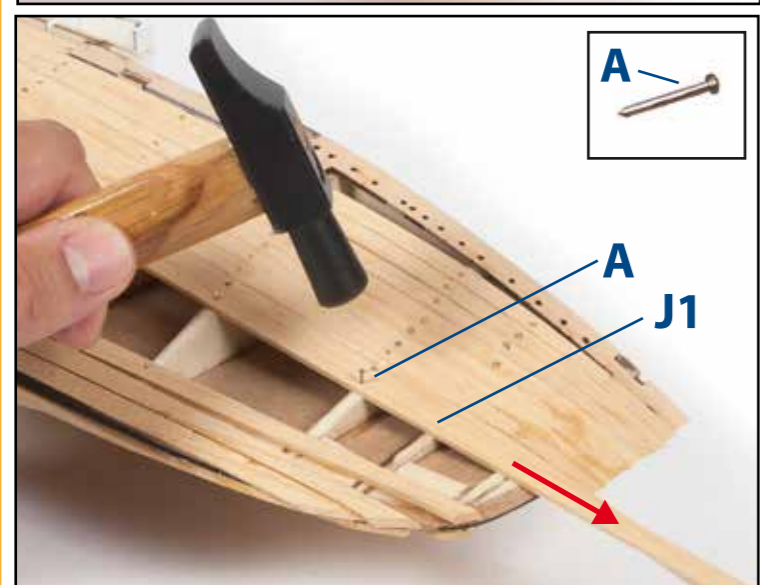
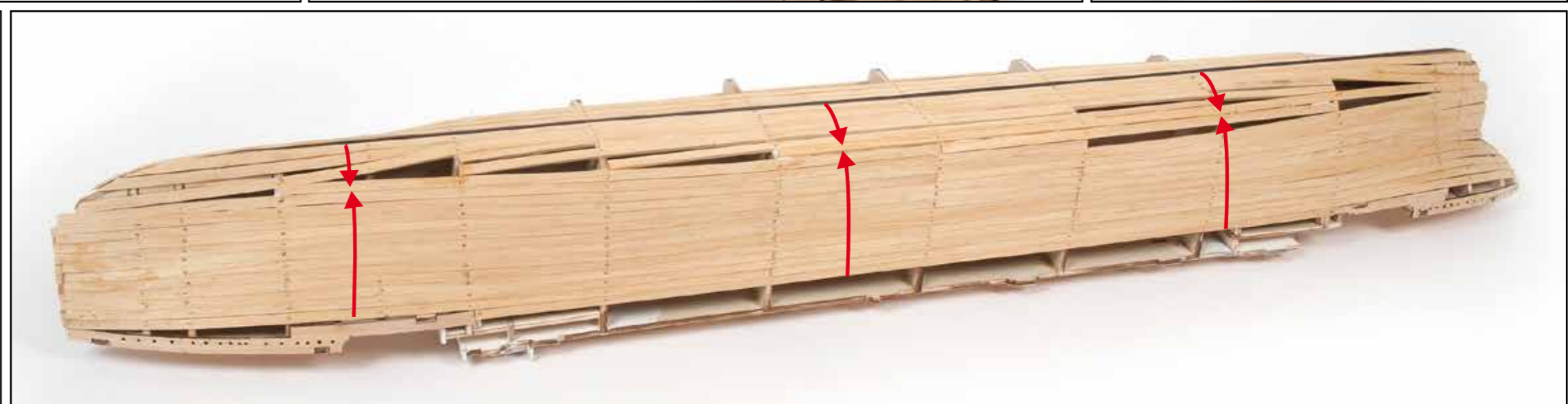
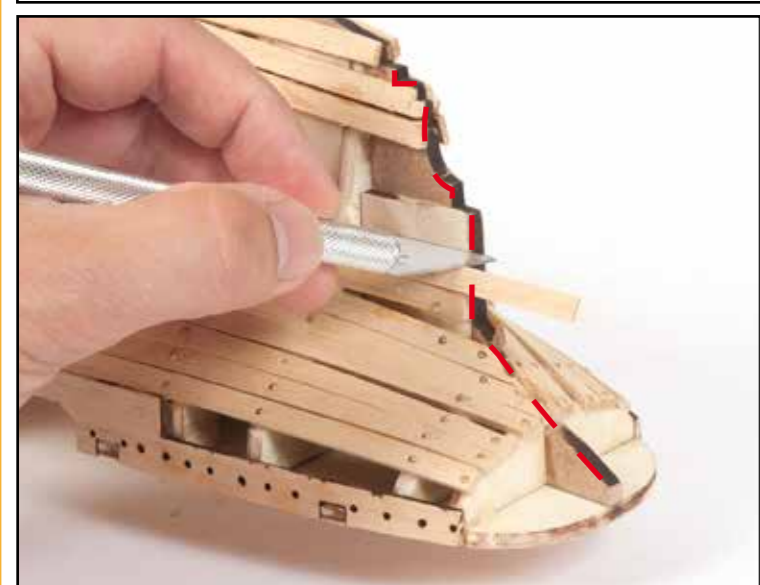
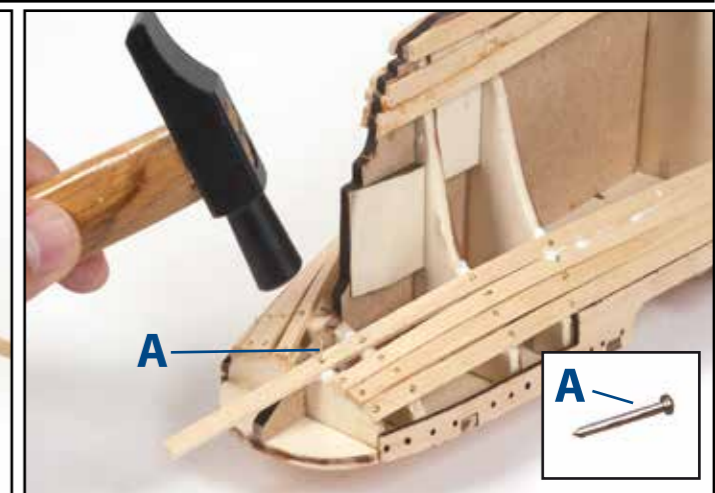
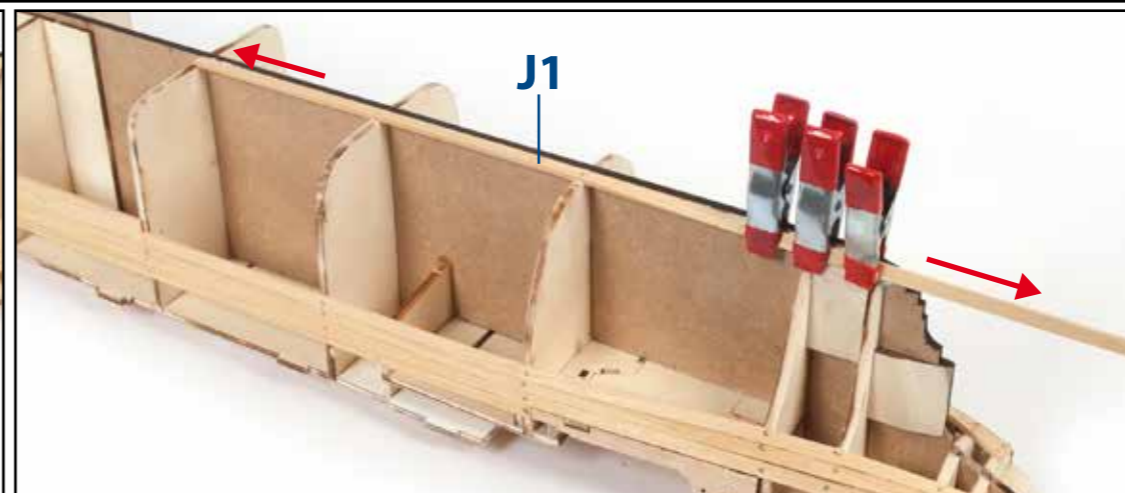
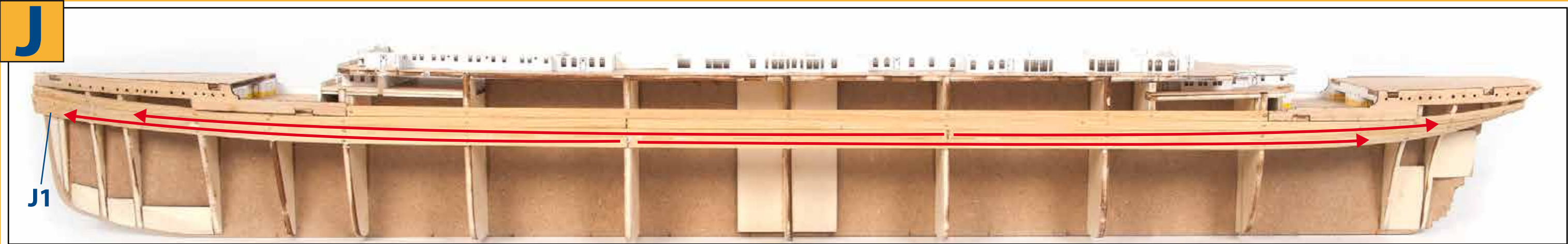

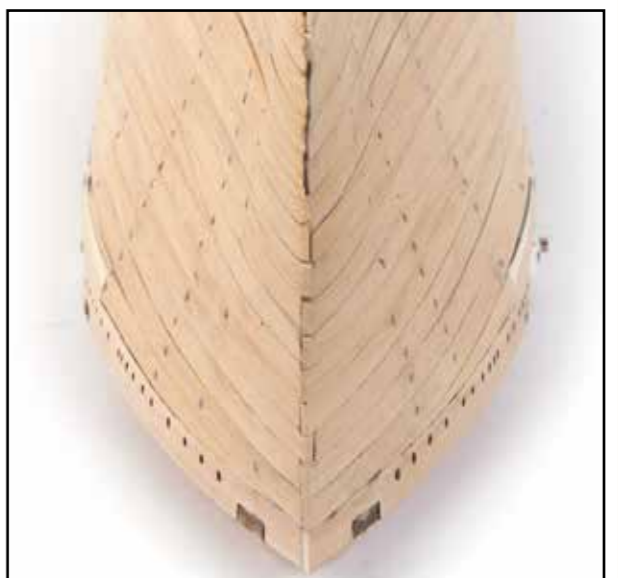
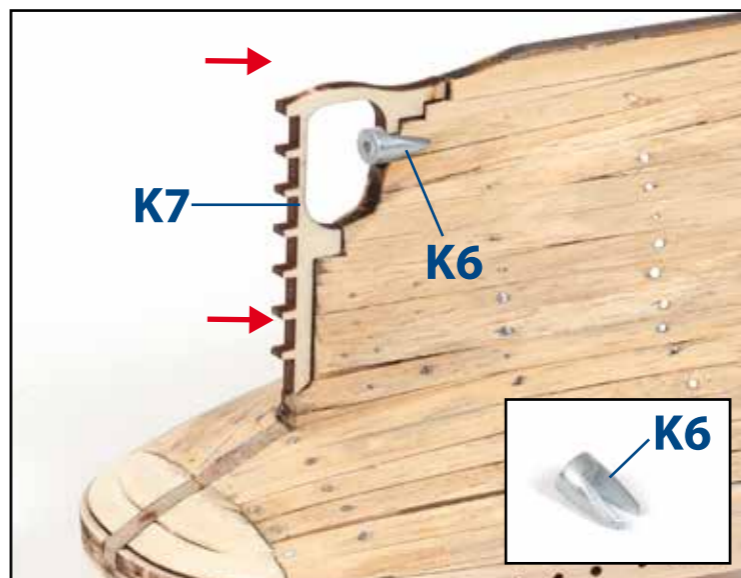
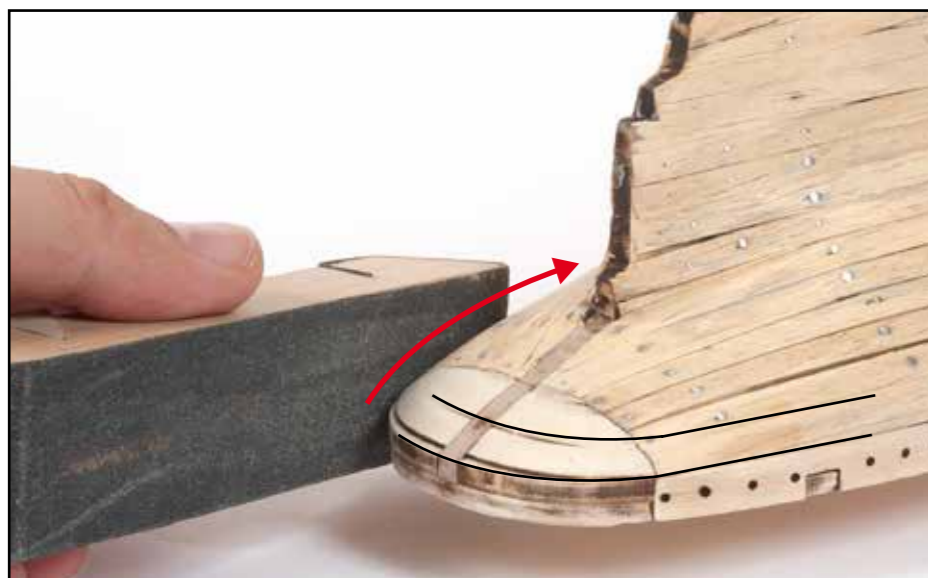
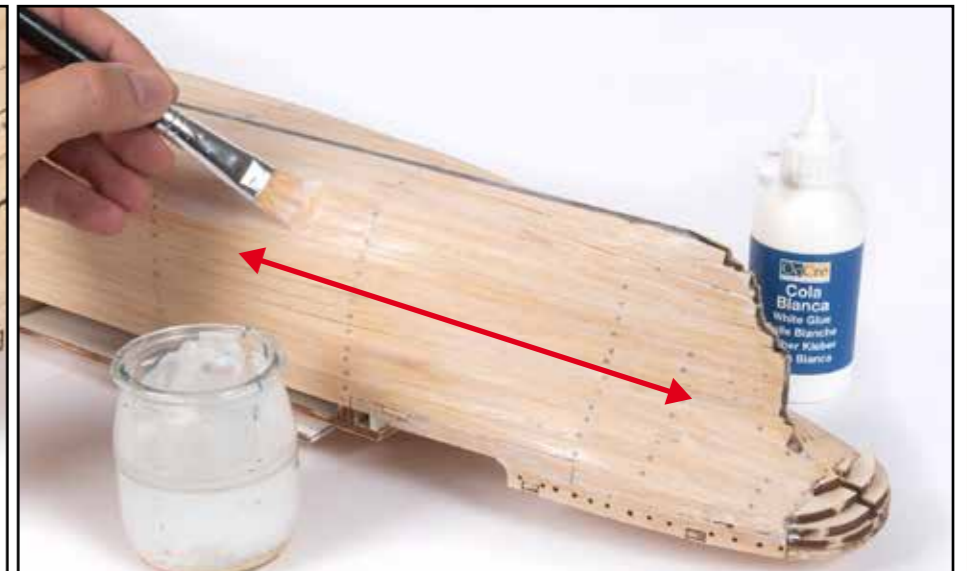
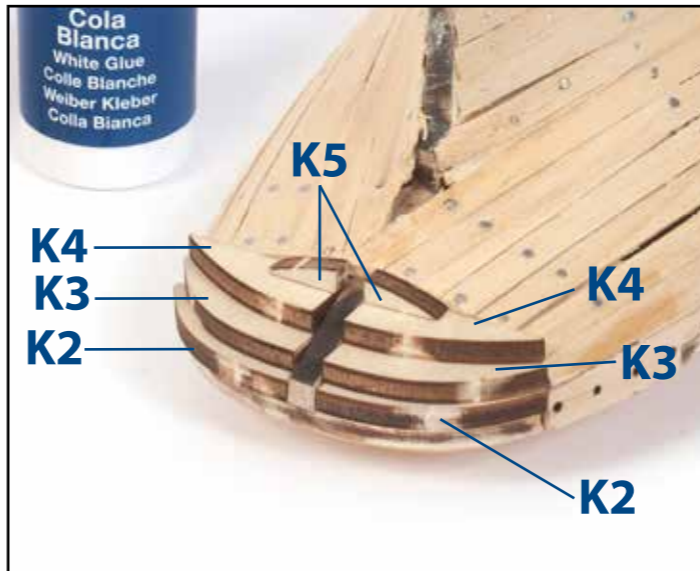
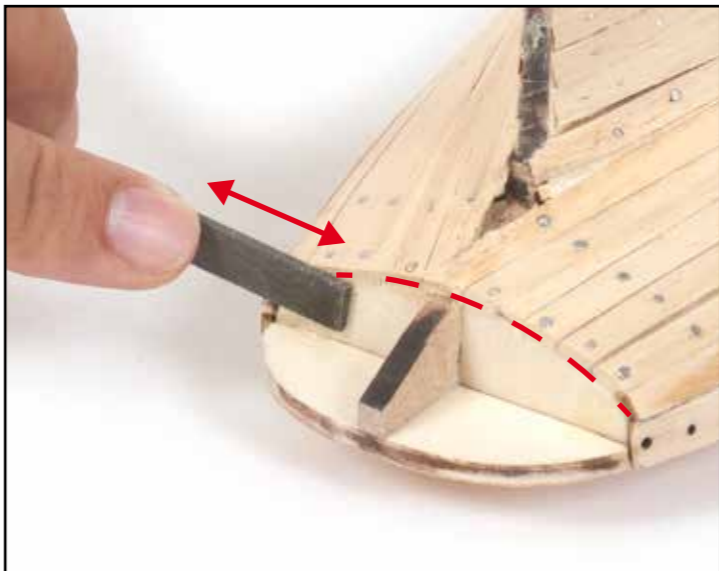
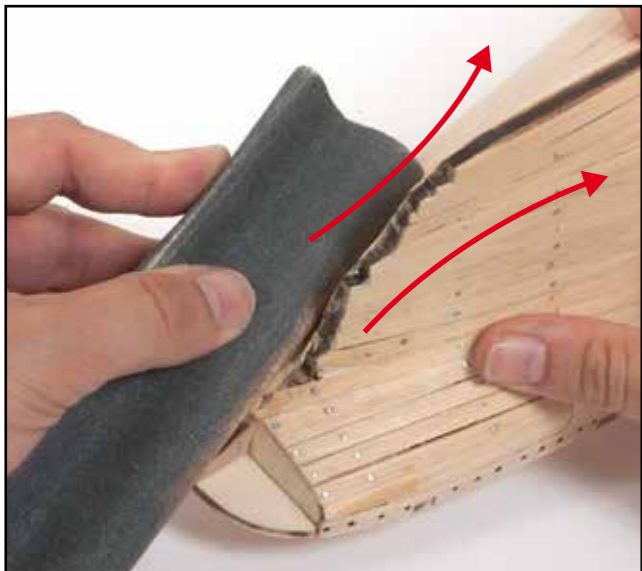
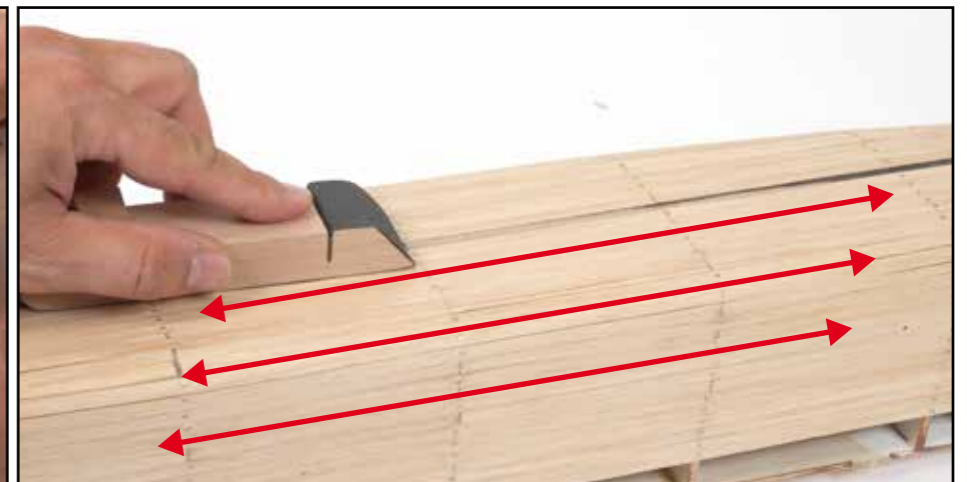
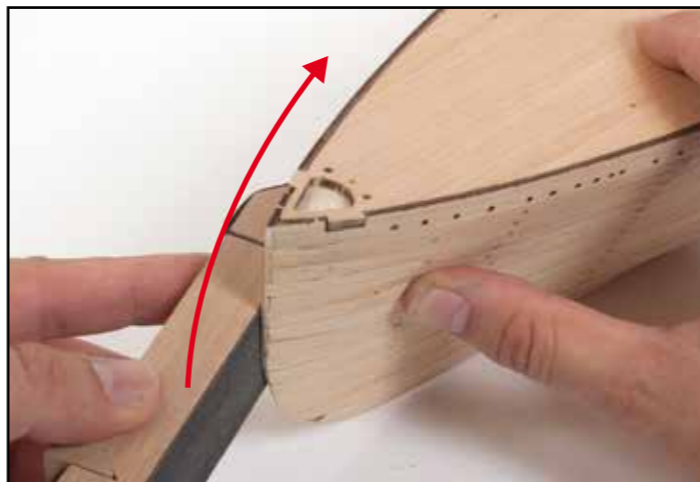
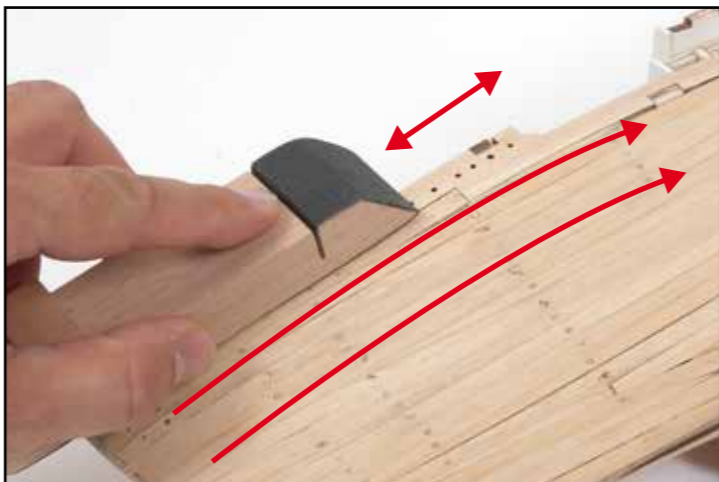
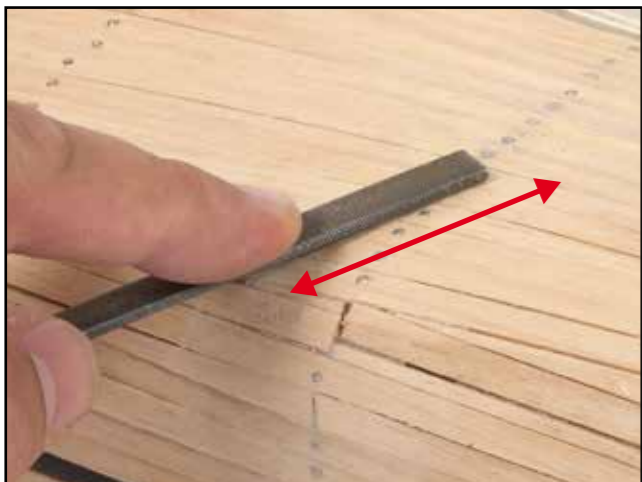
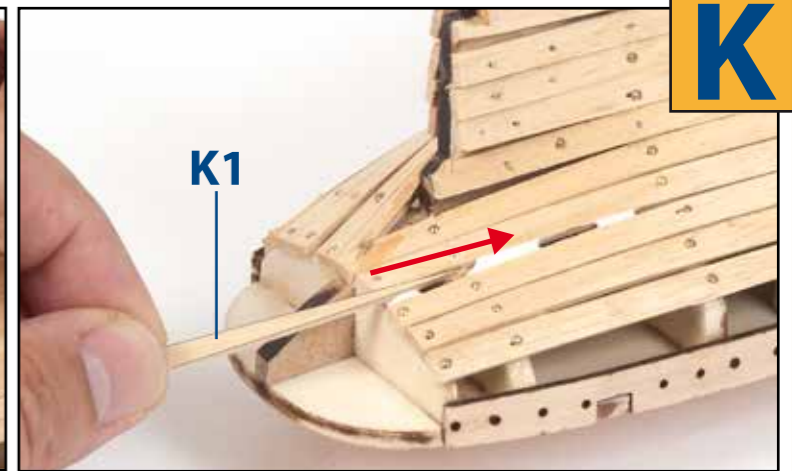
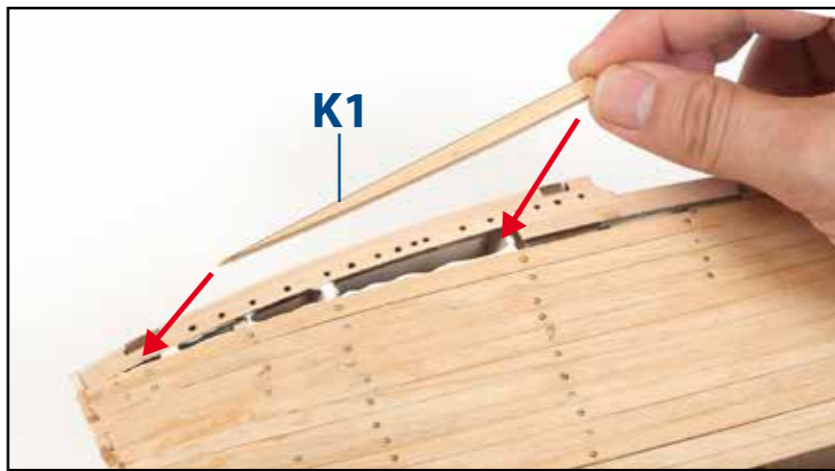
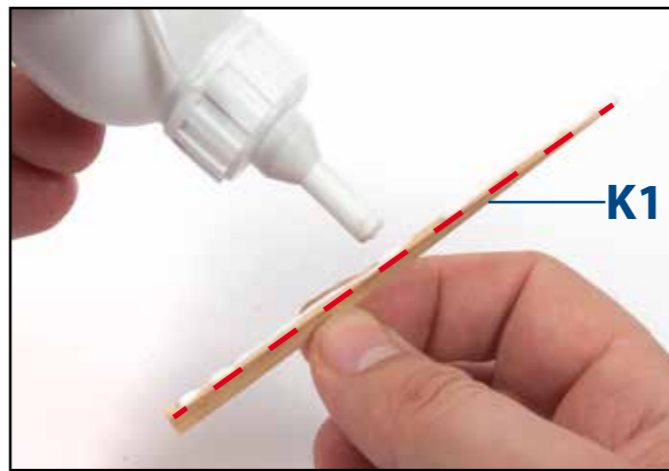
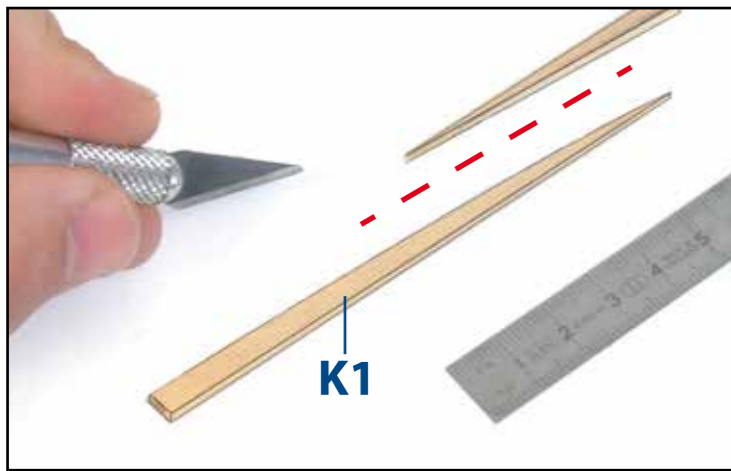

L

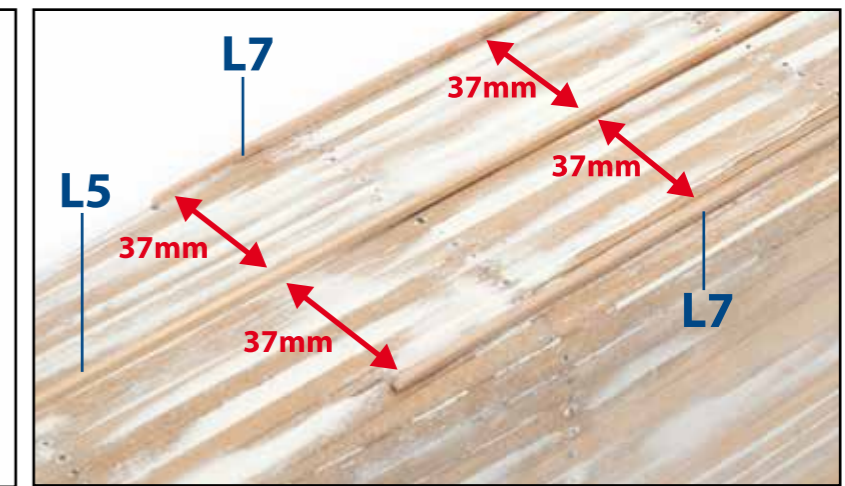
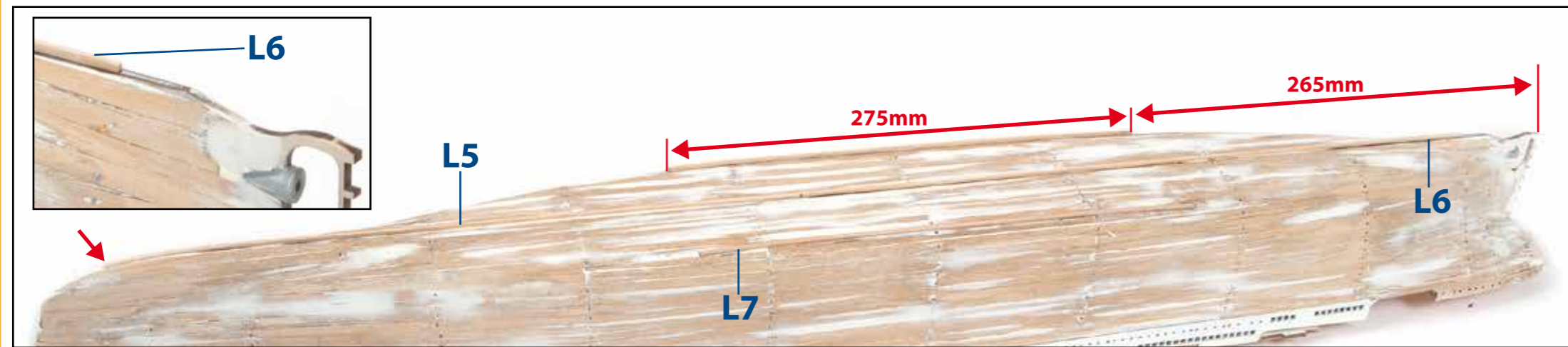
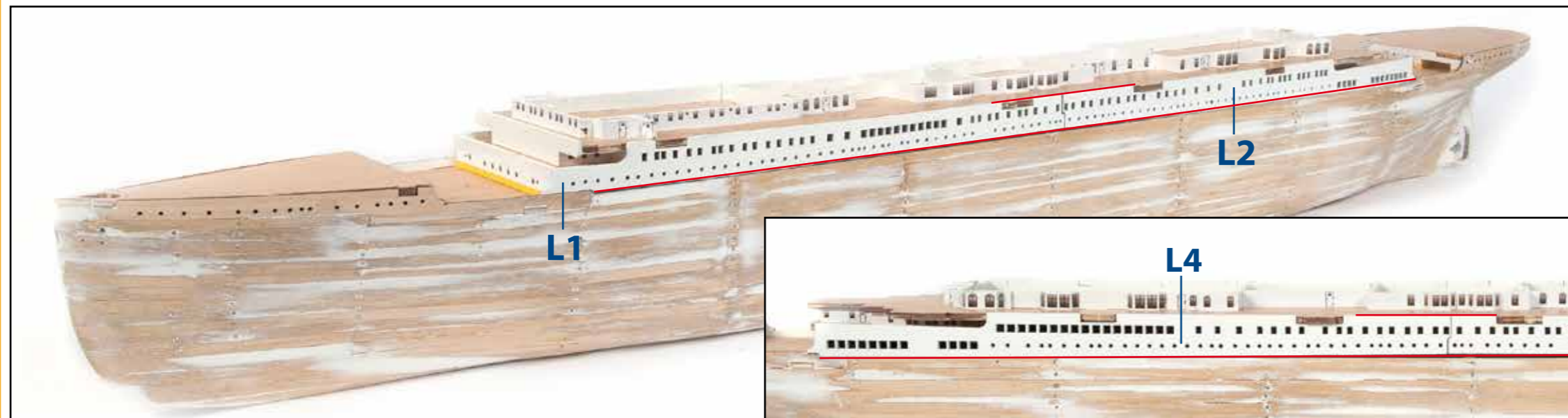
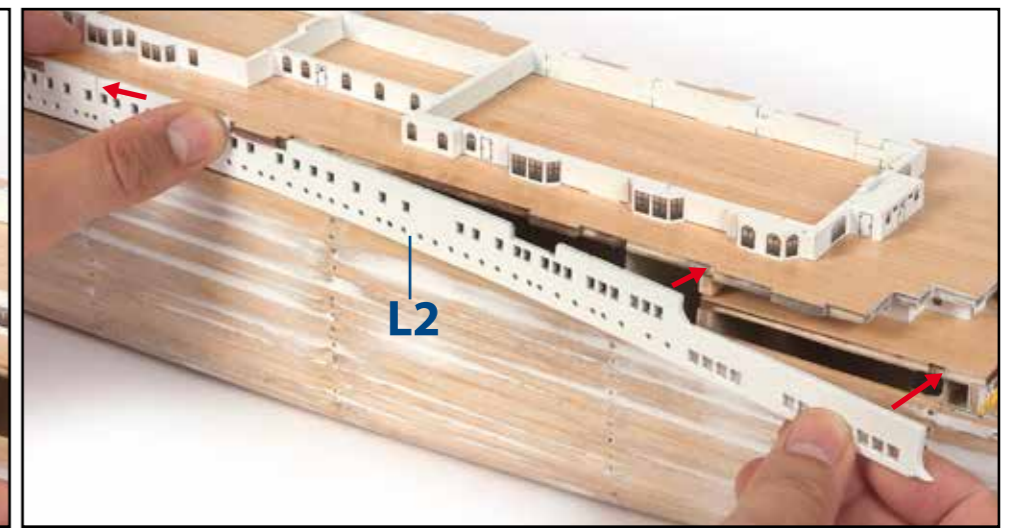
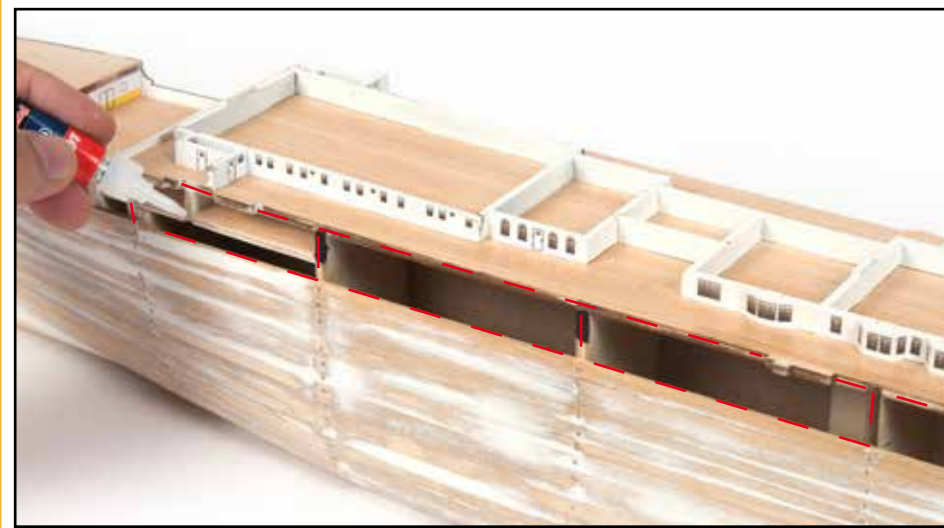
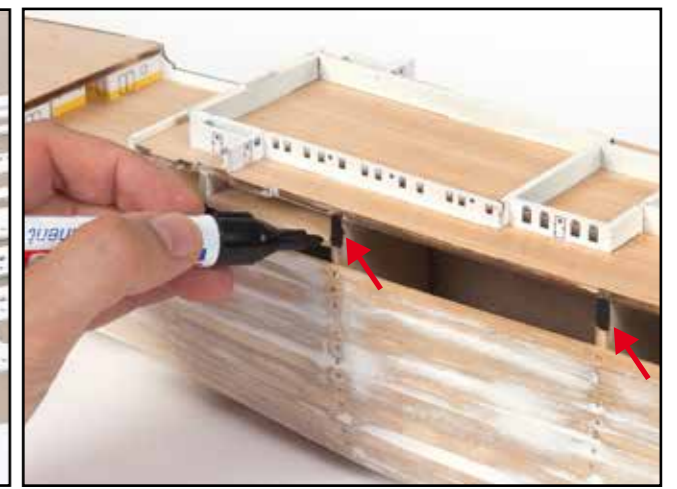
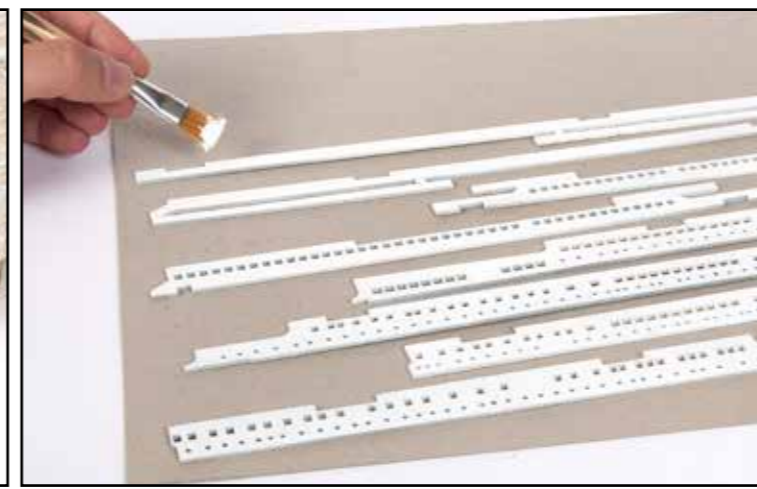
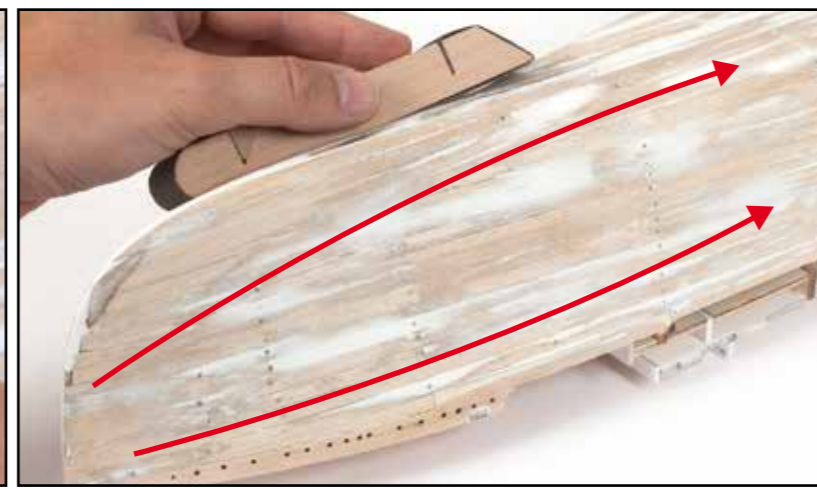



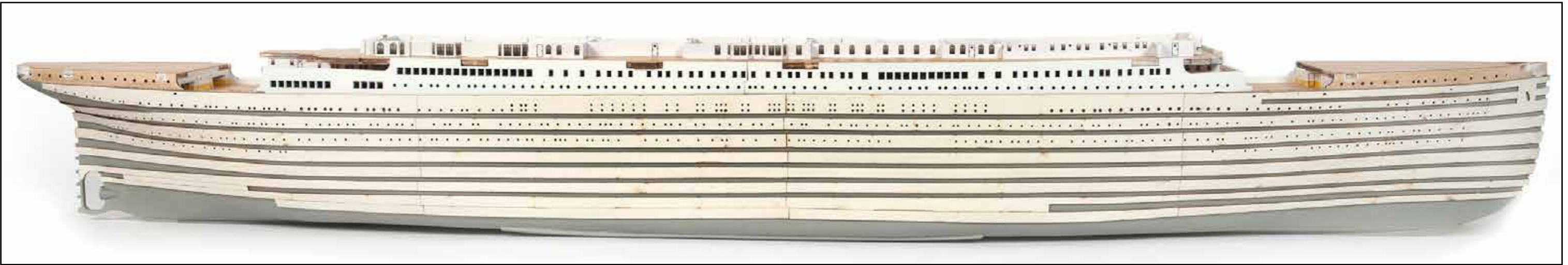
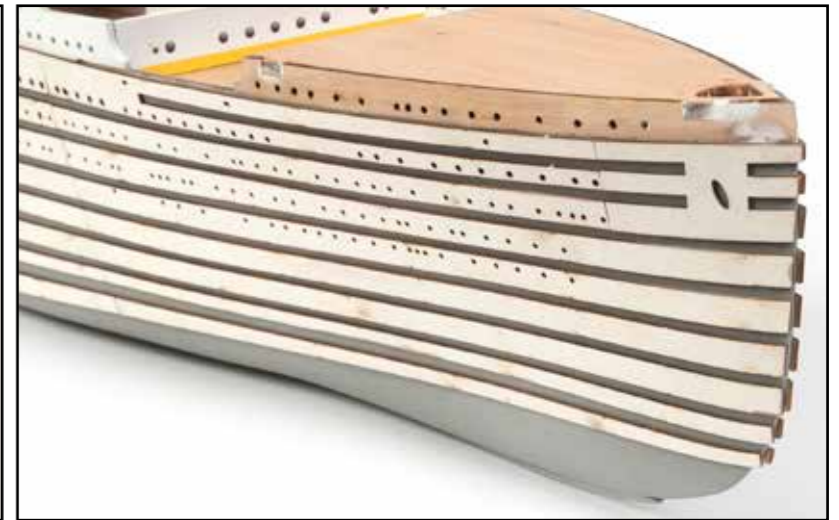
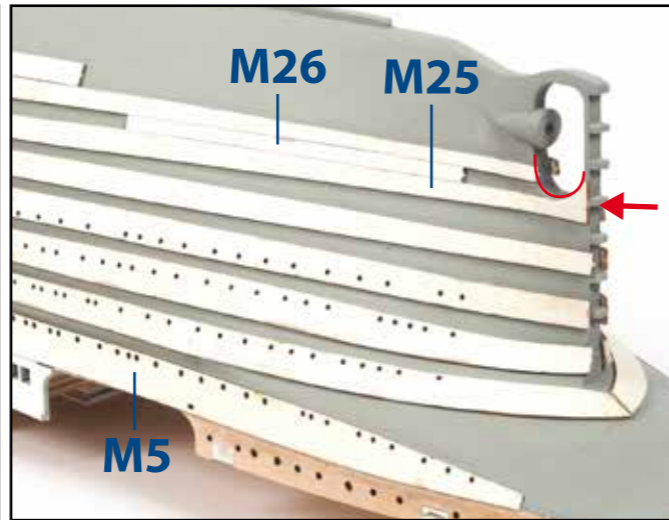
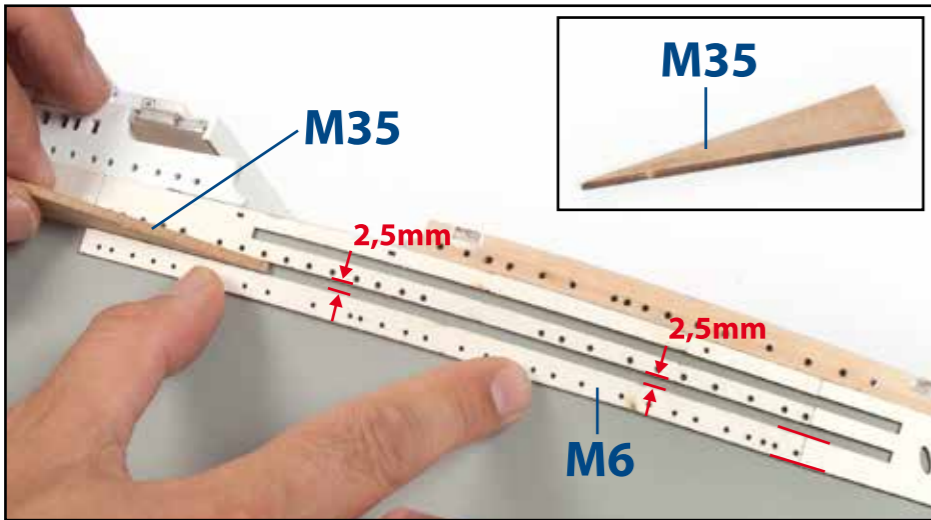
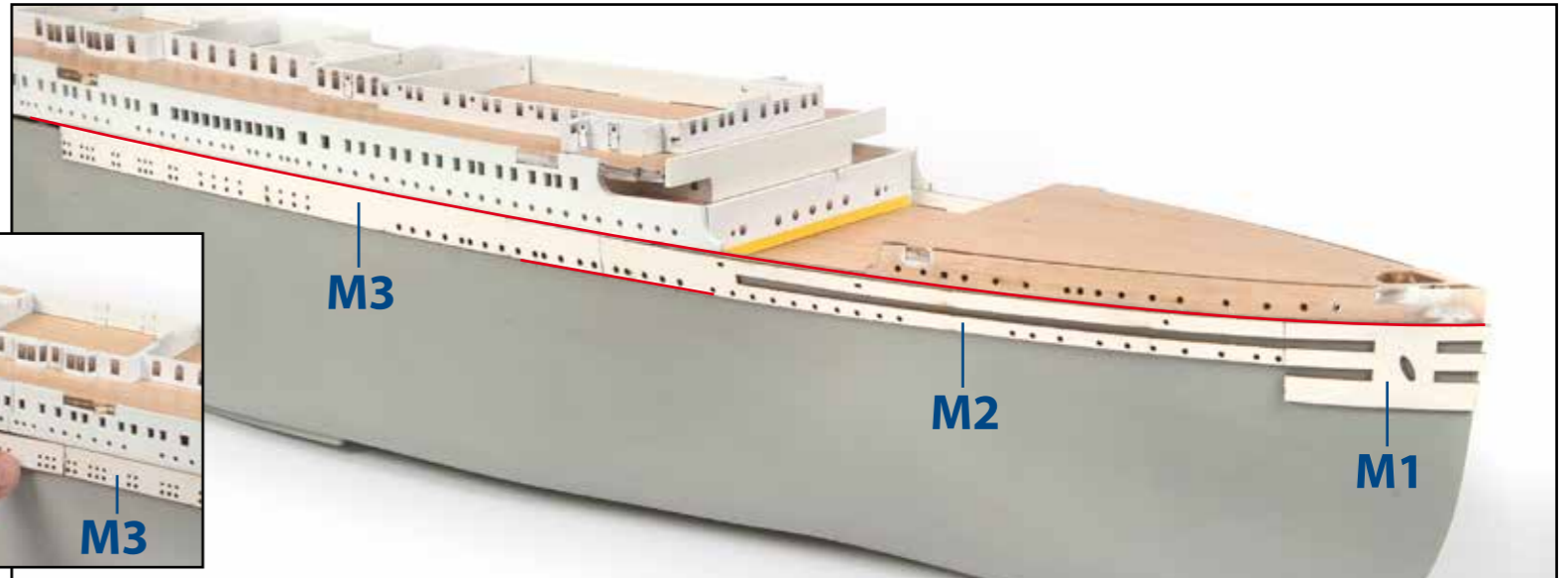
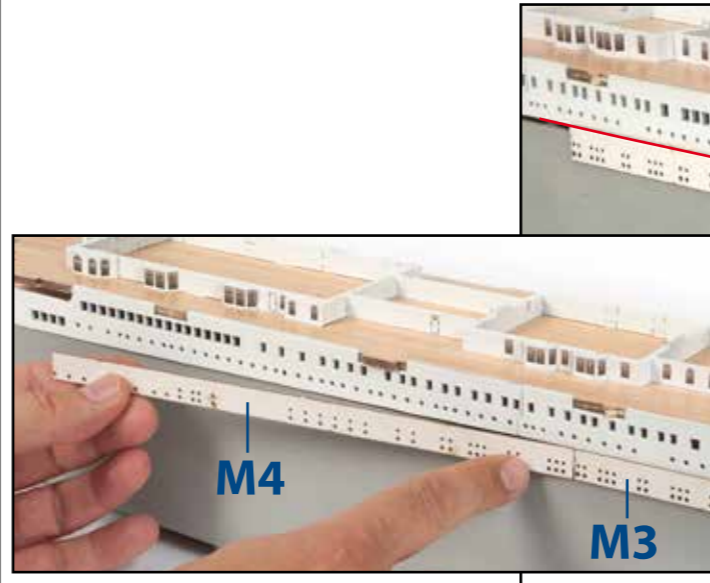
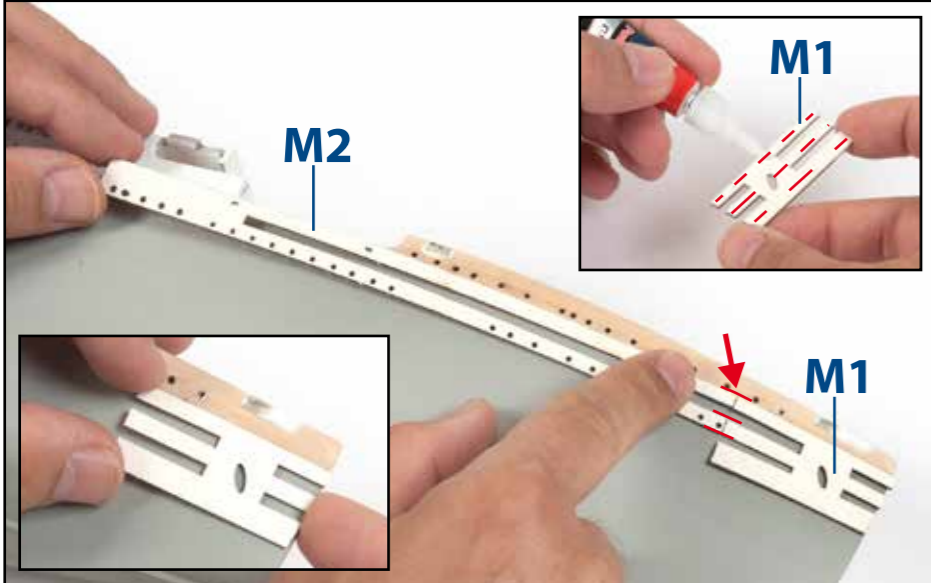
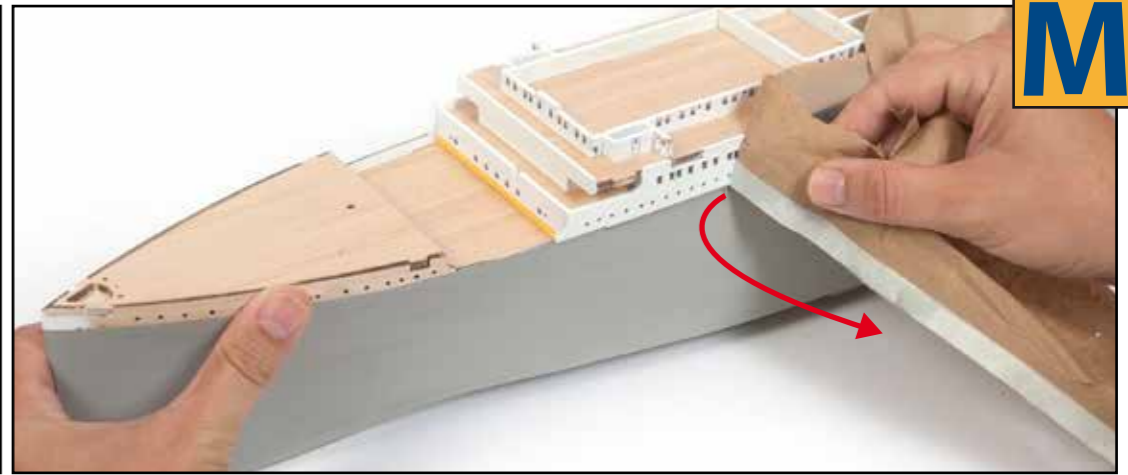
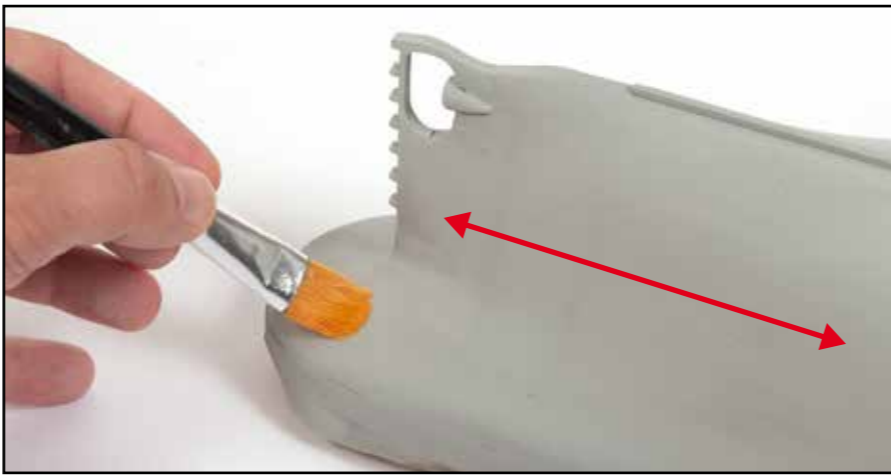
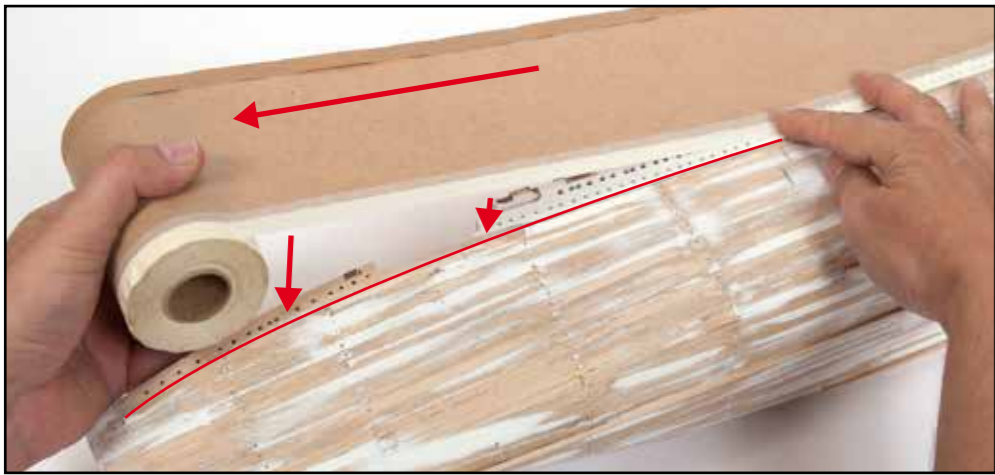

**N**

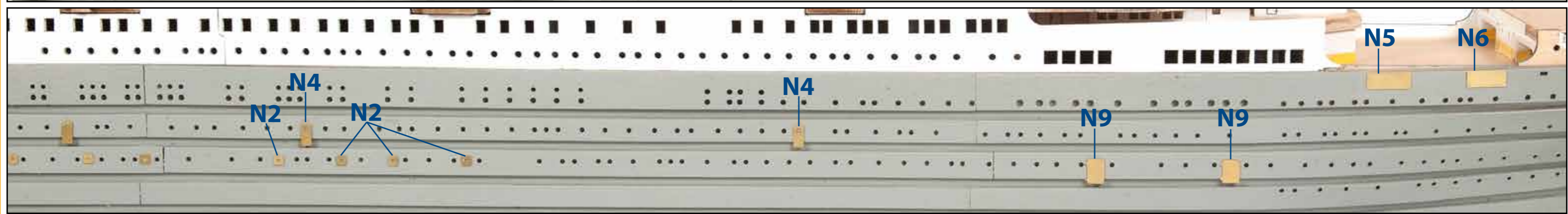
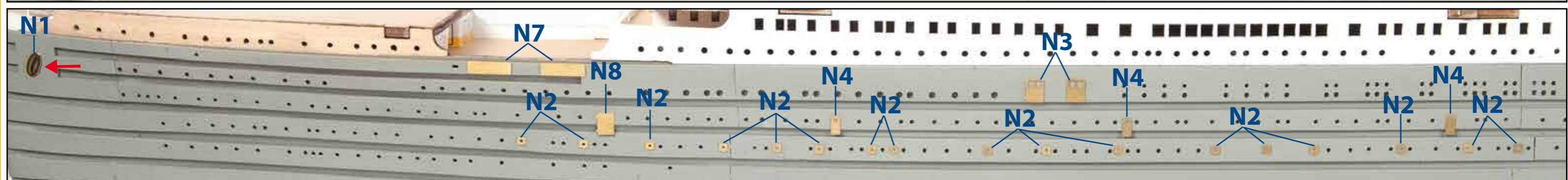
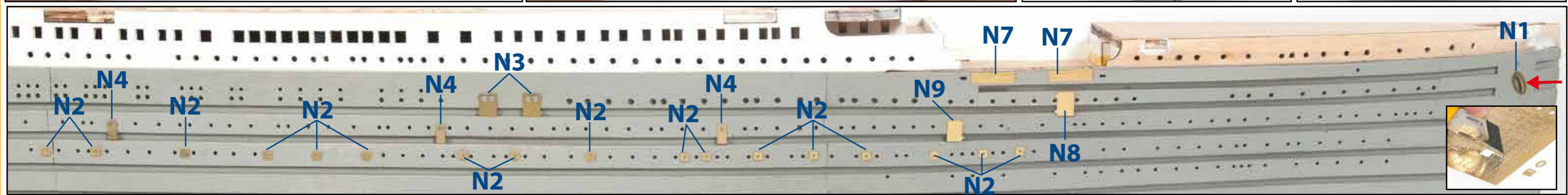
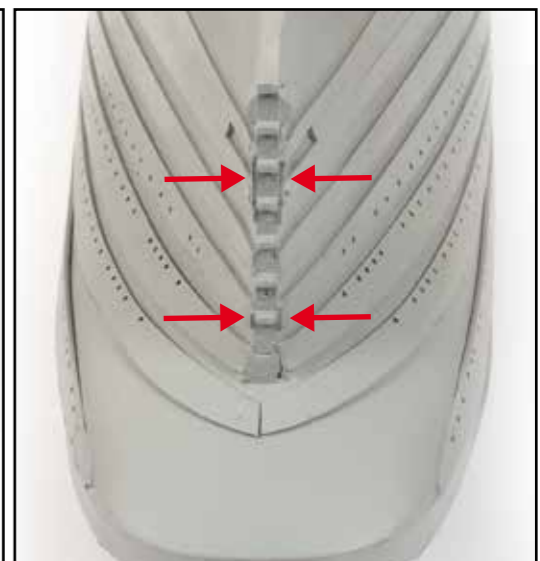
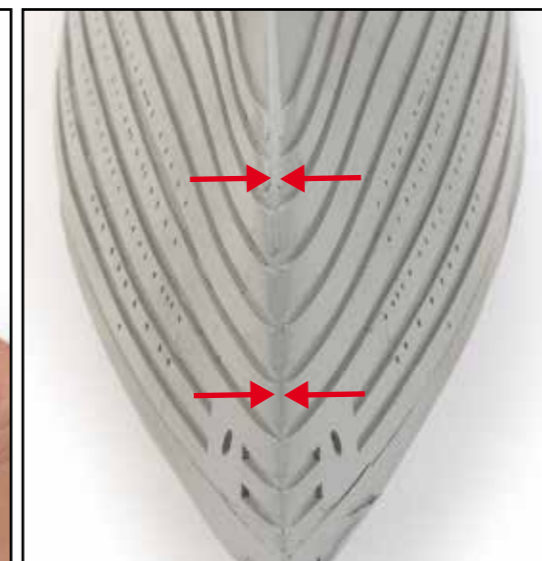
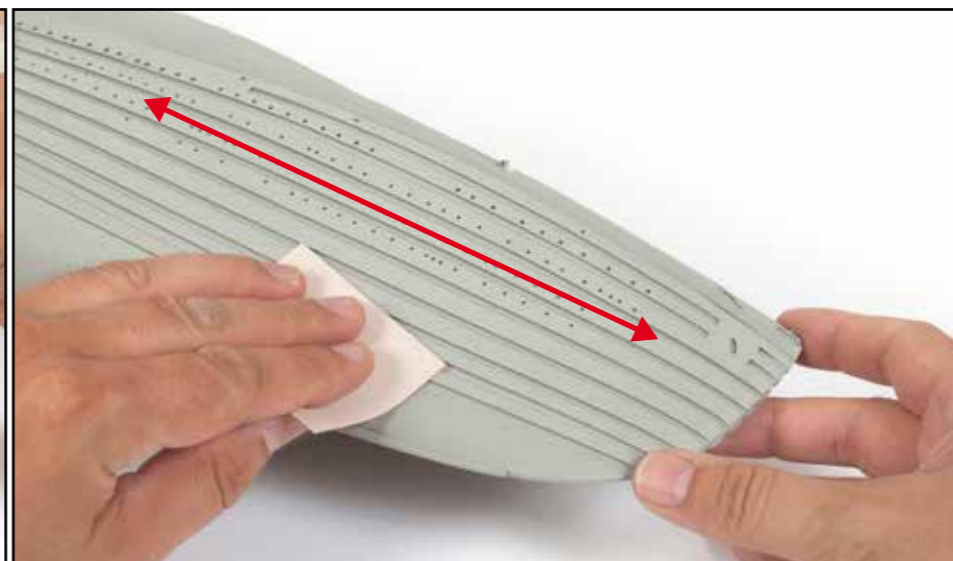
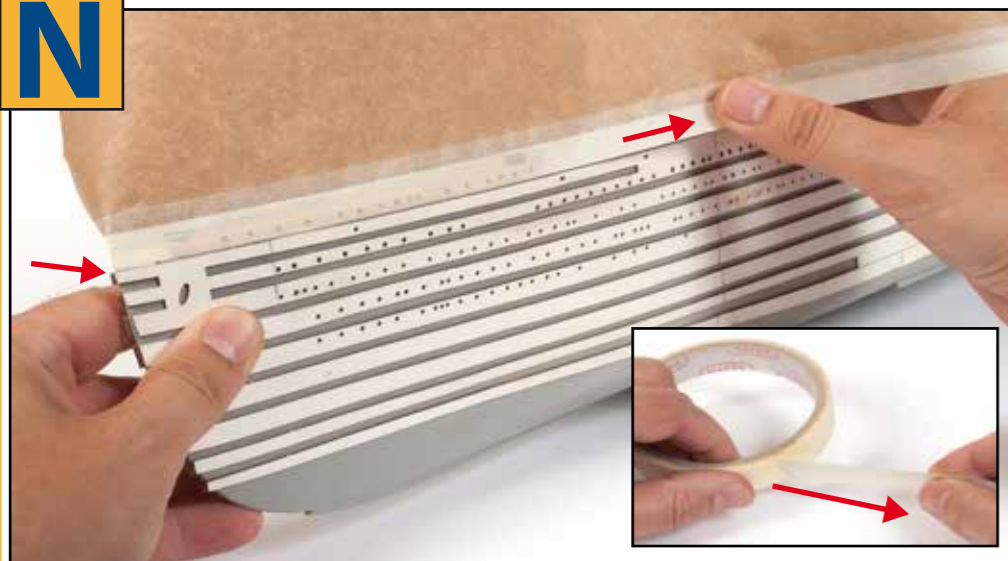

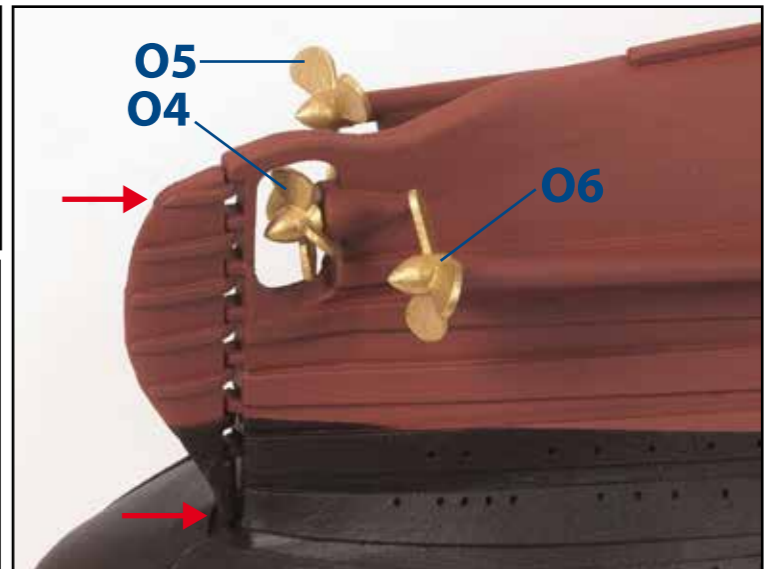
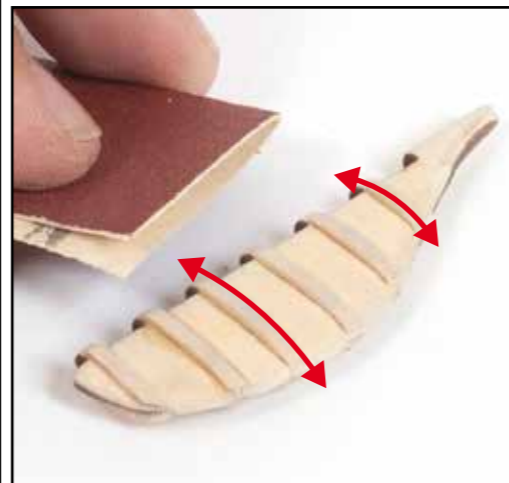
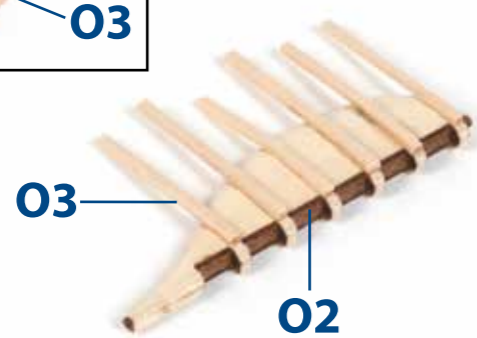
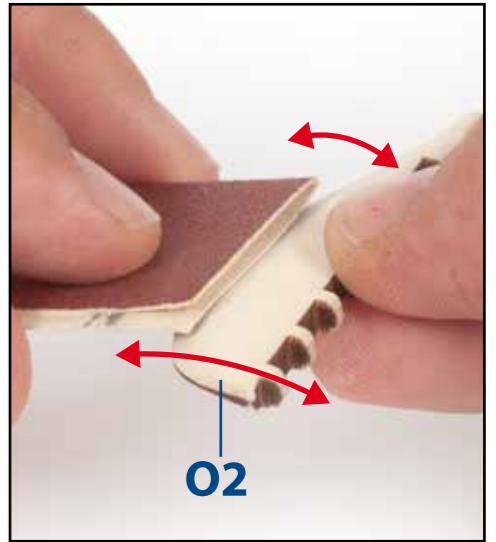
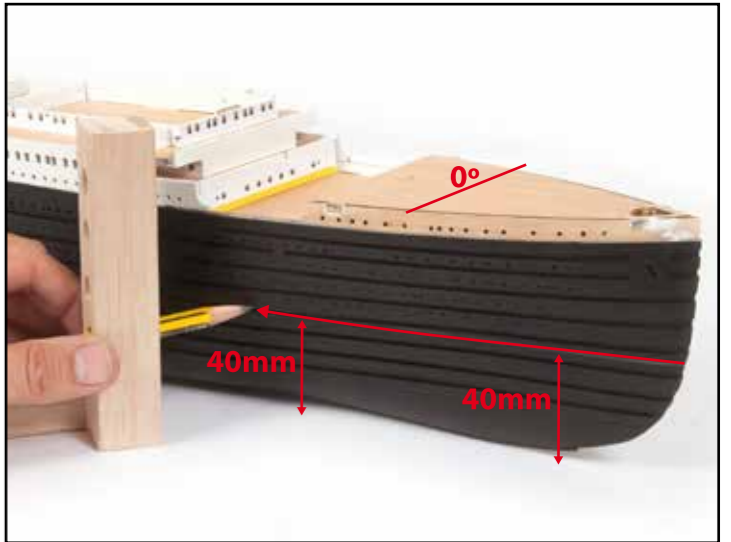
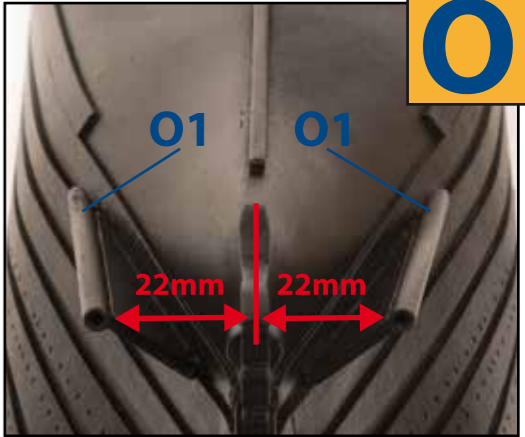
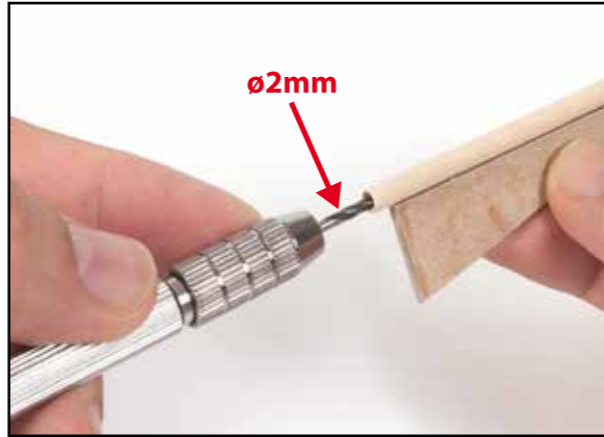
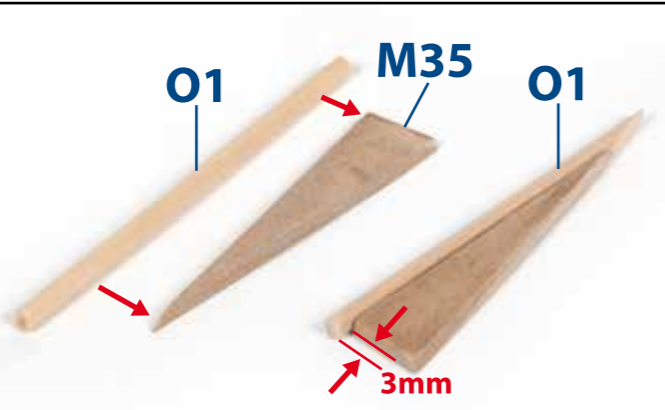
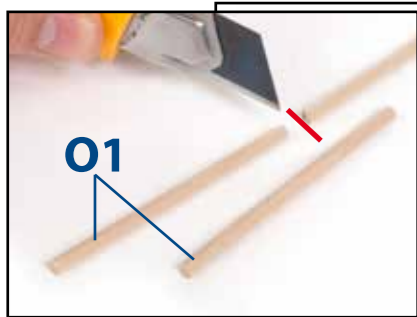

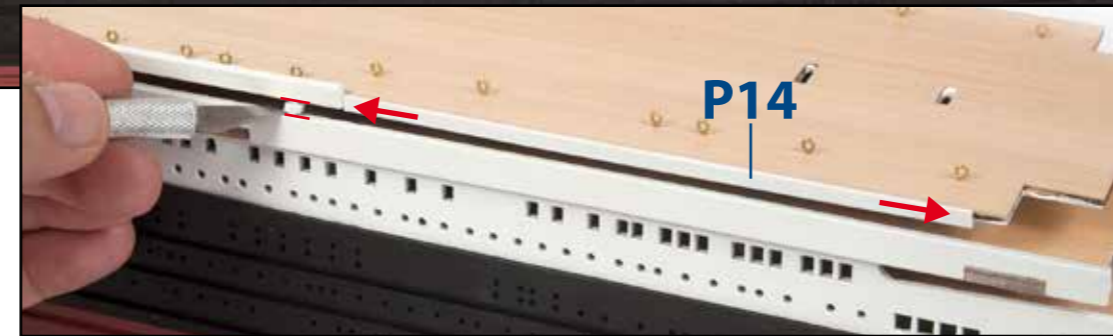
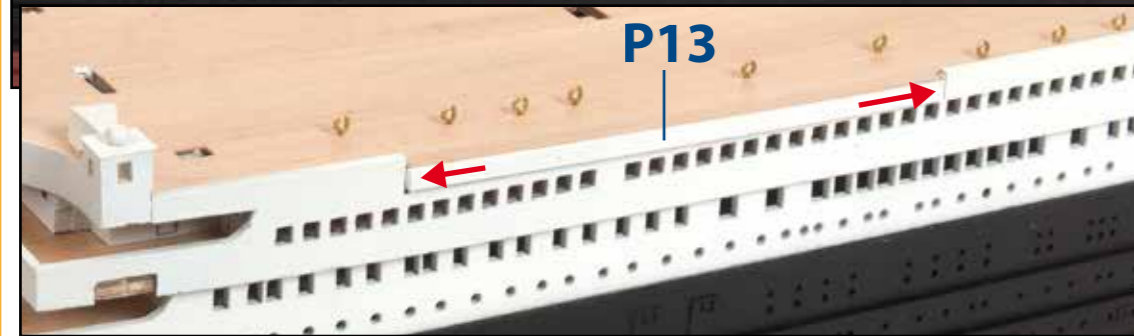
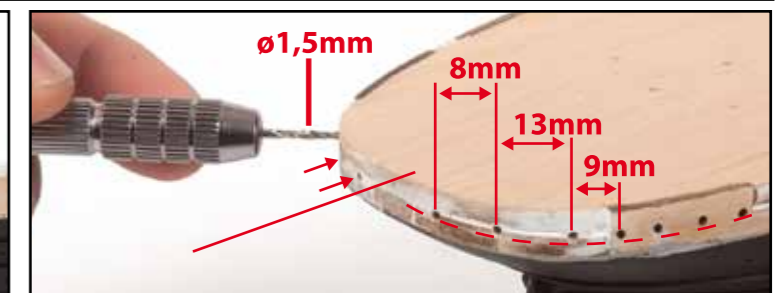
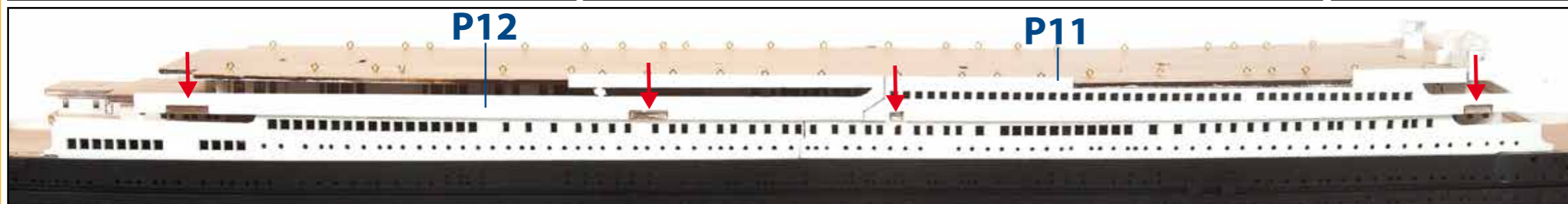
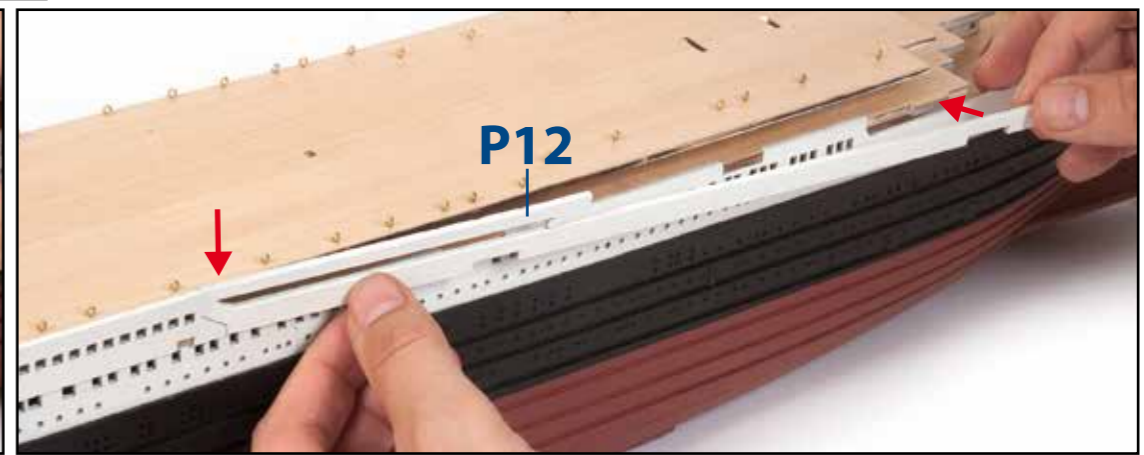
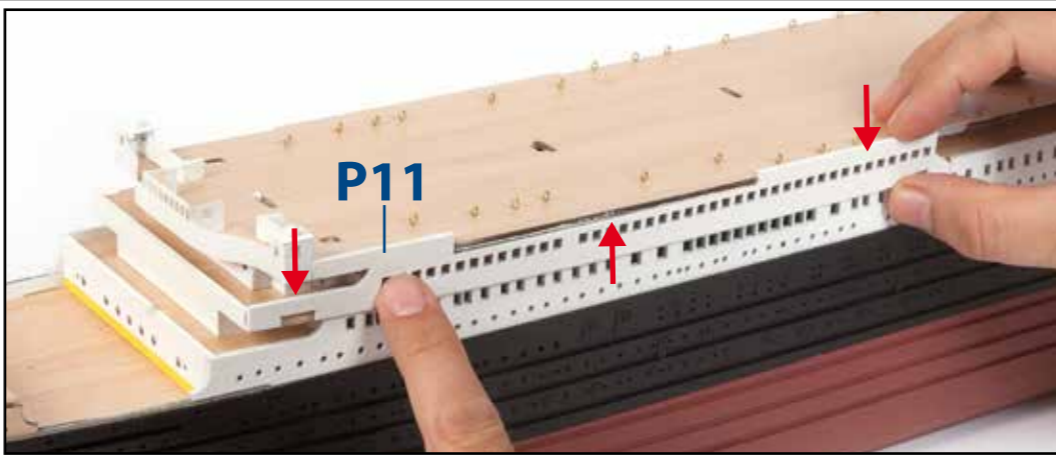
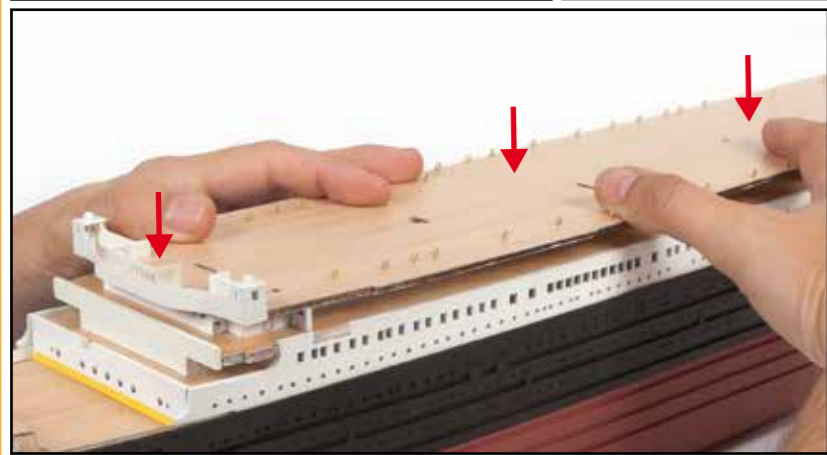
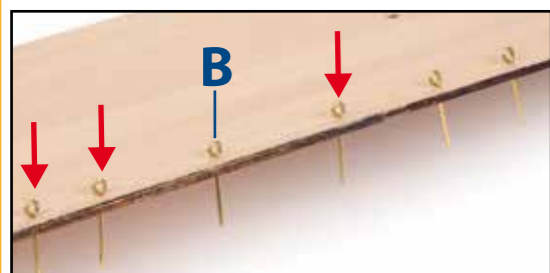
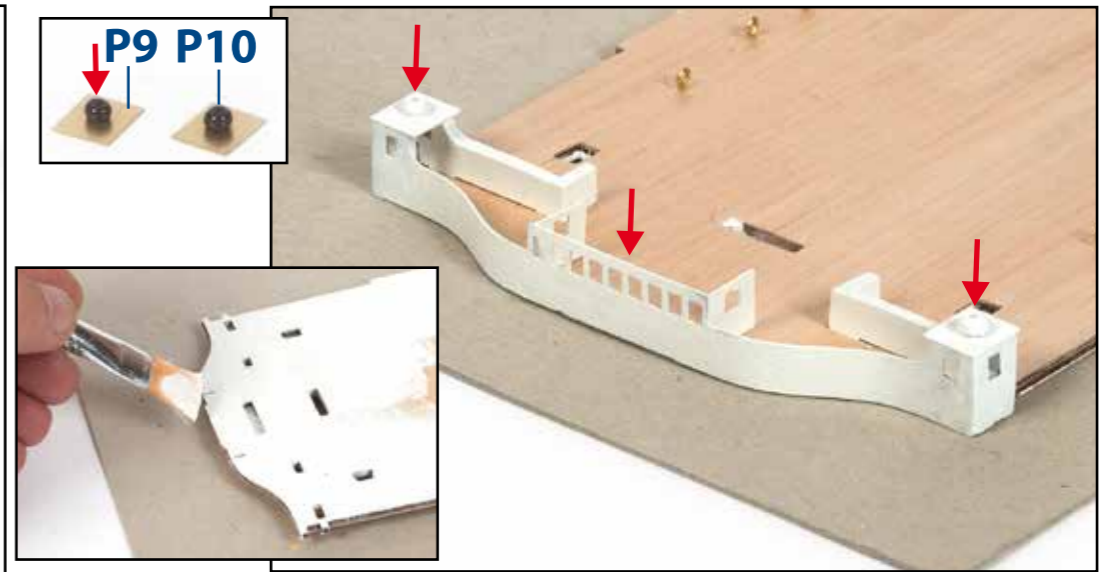
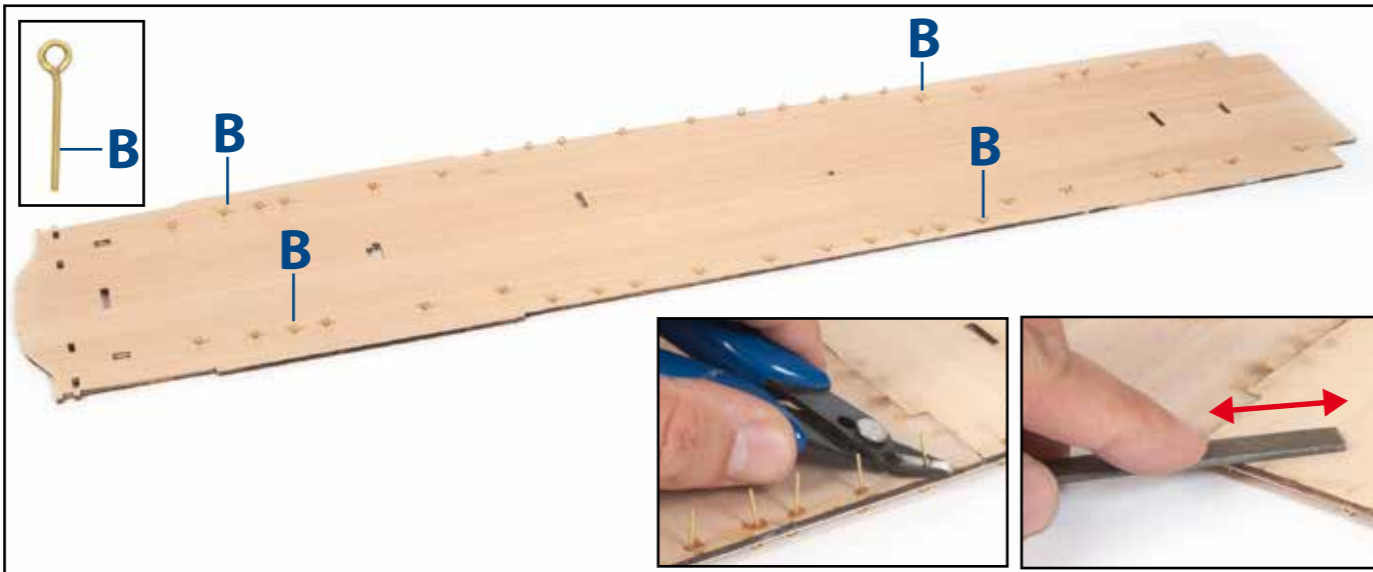
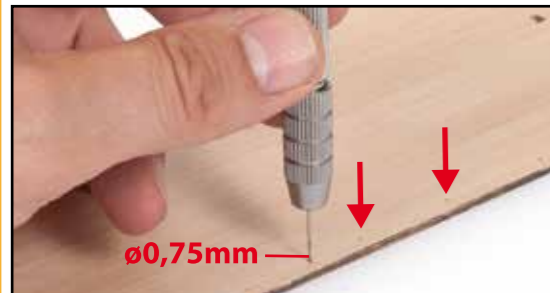
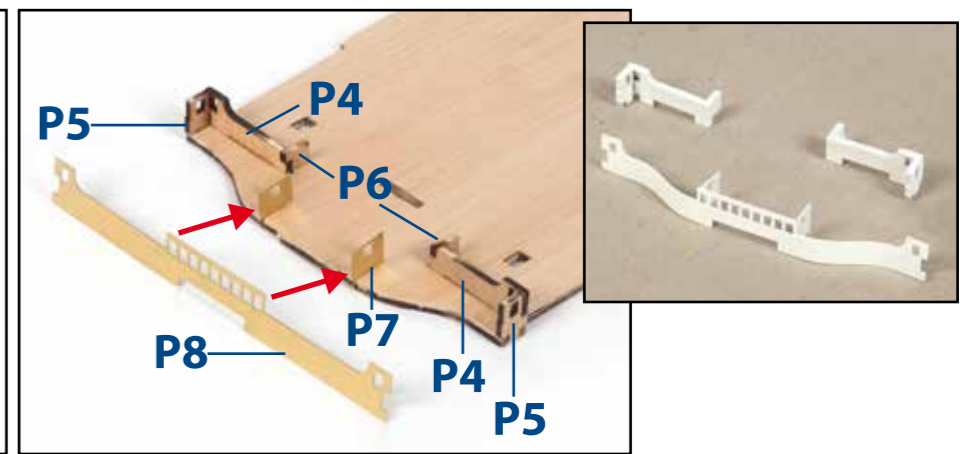
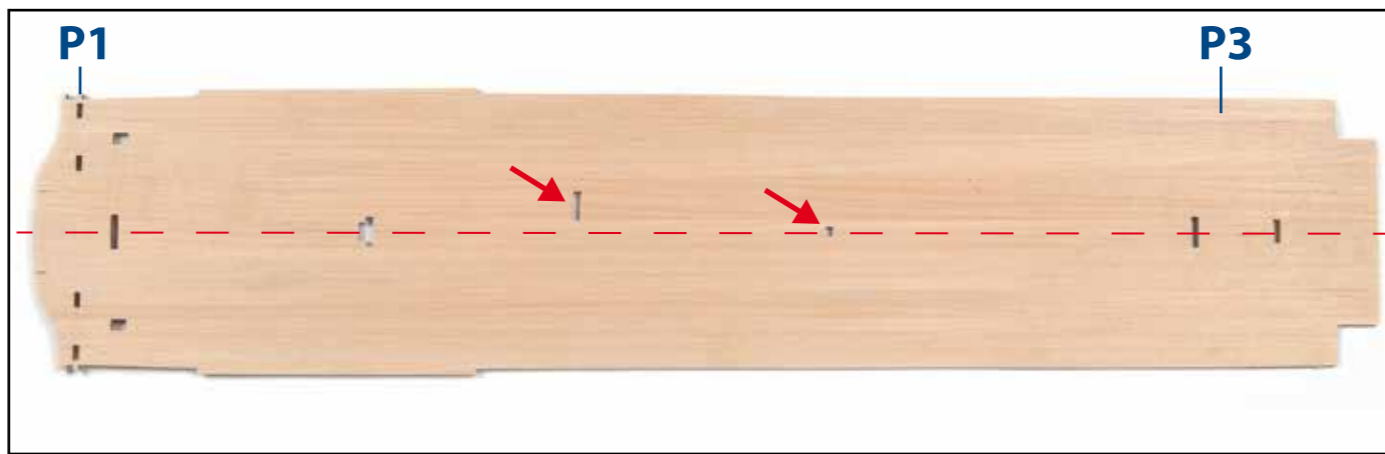
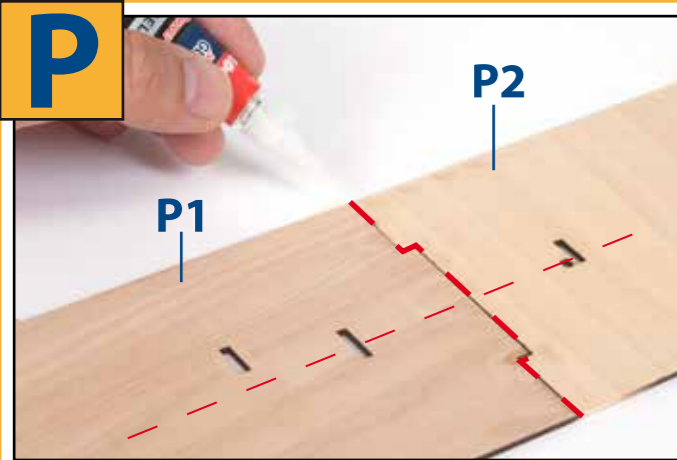

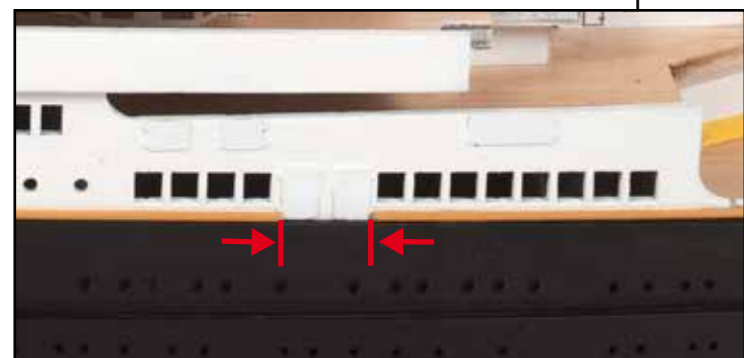
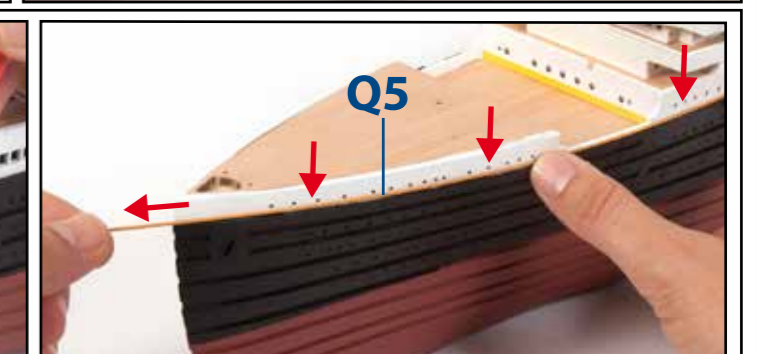
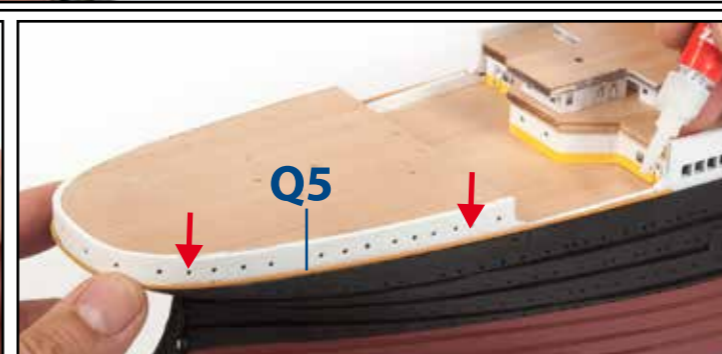
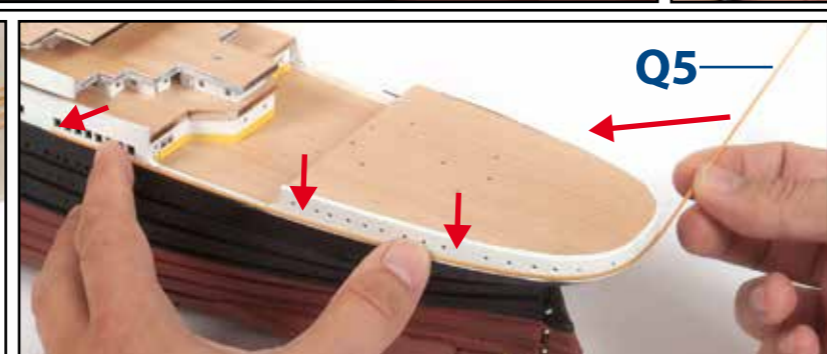
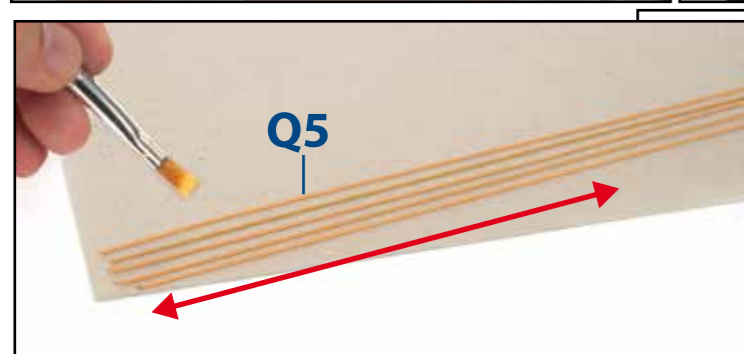
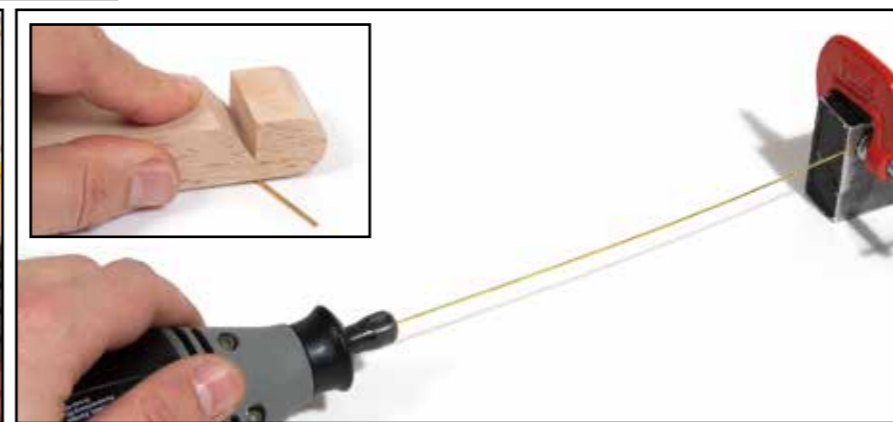
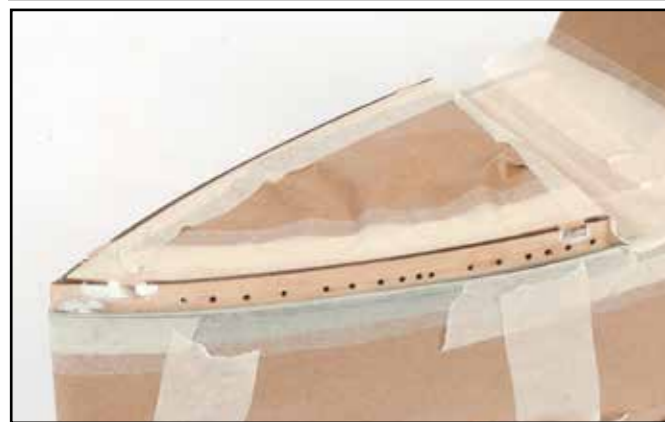
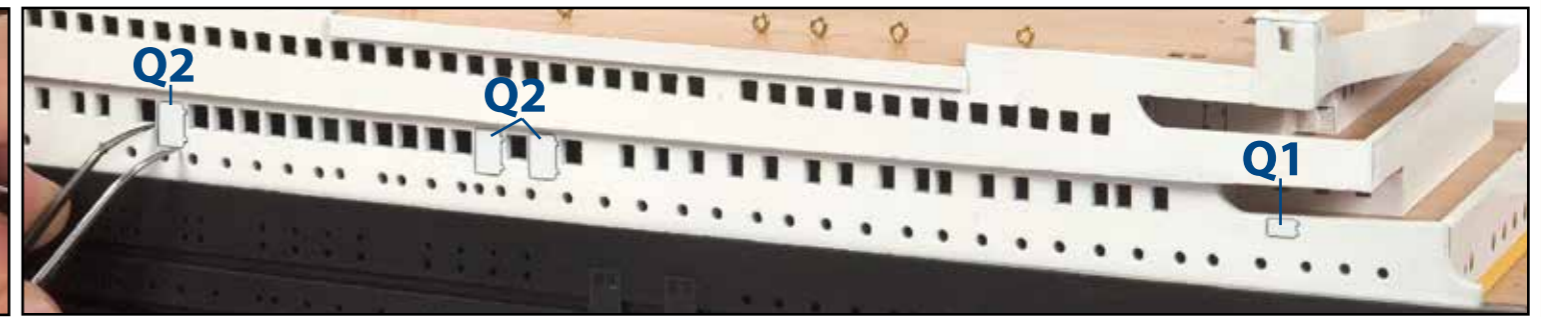
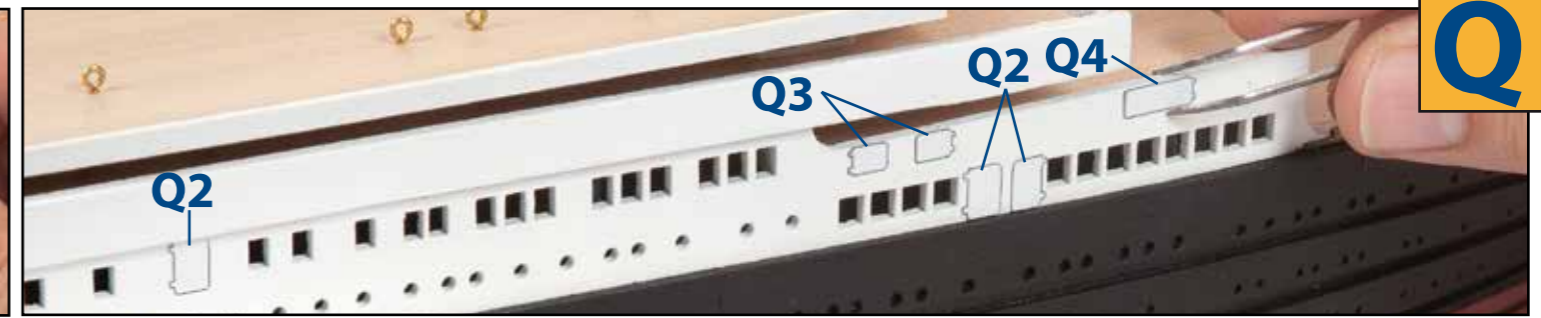
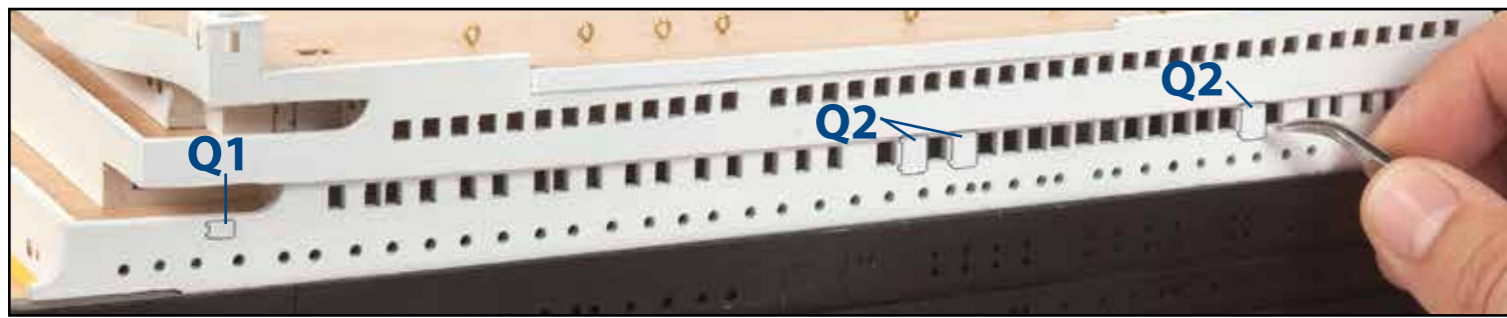

**R**

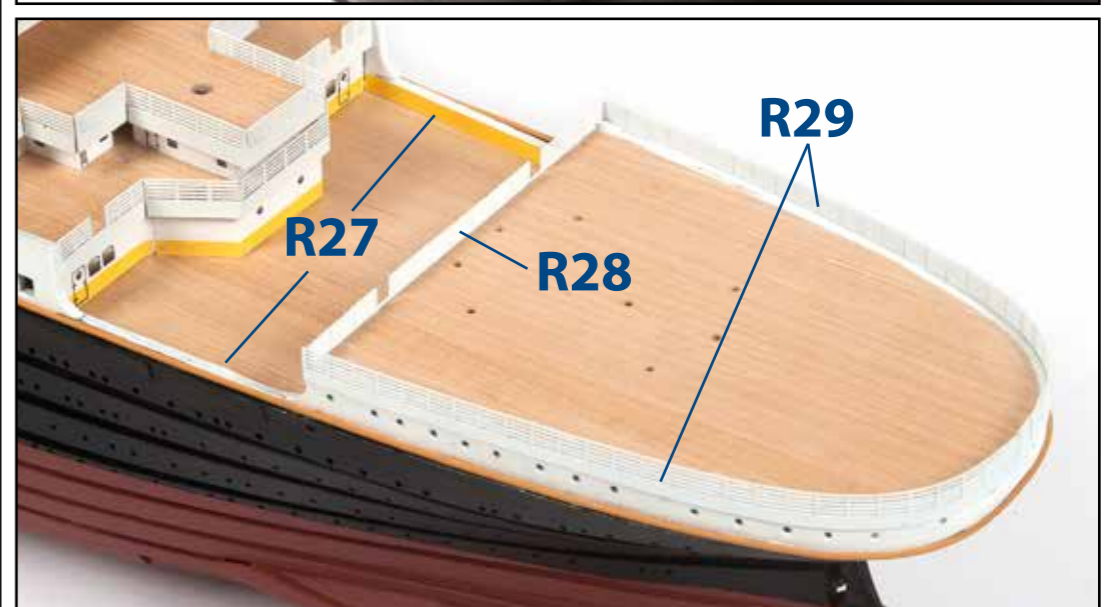
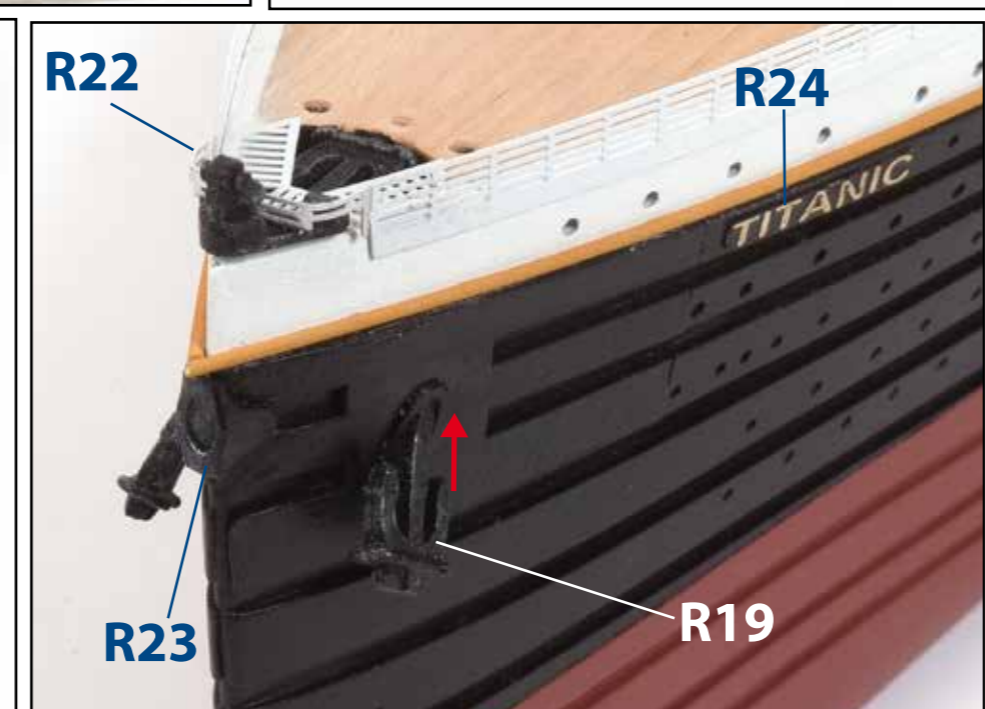
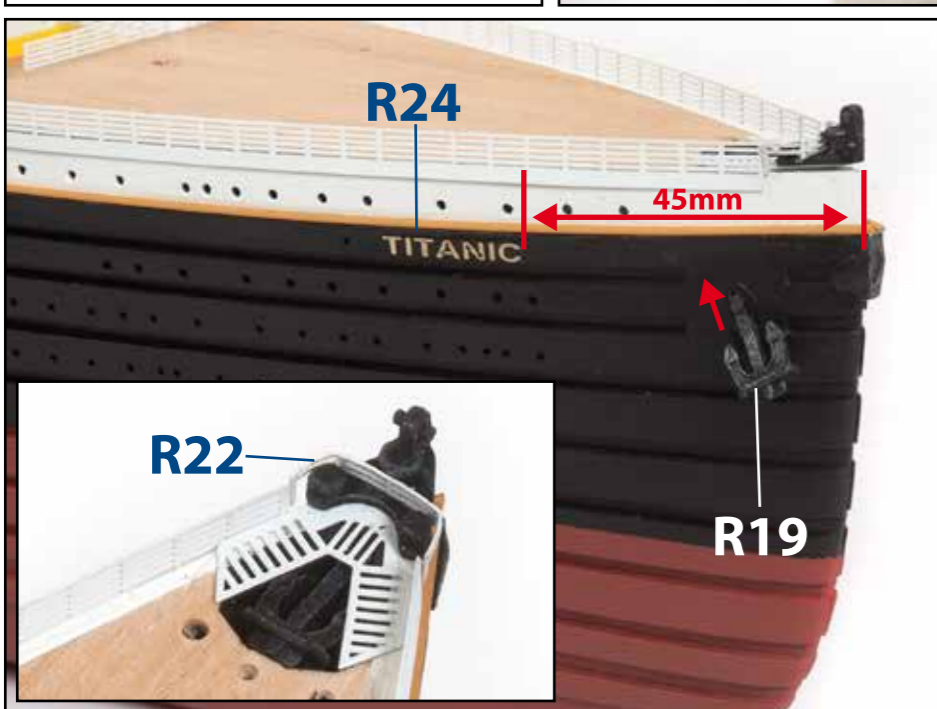
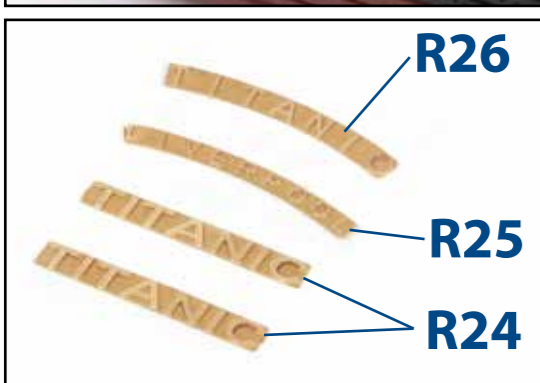
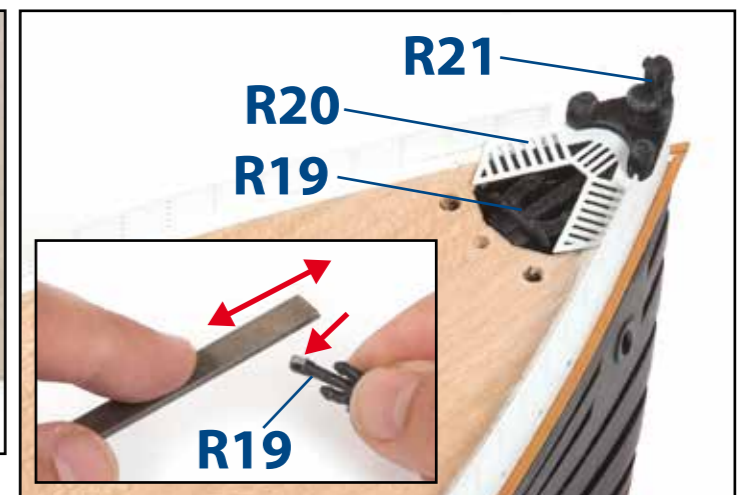
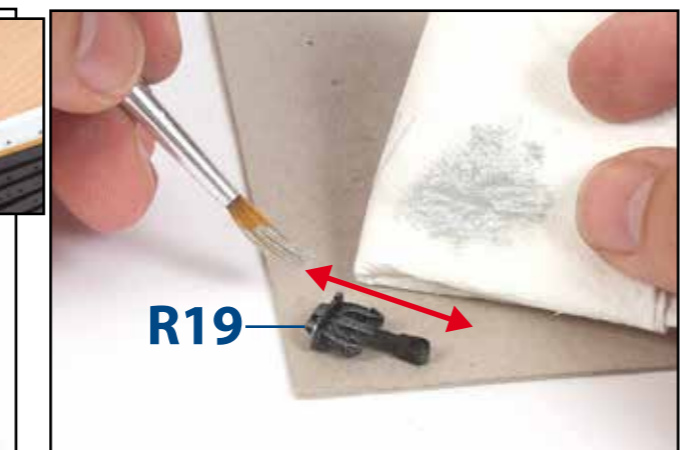
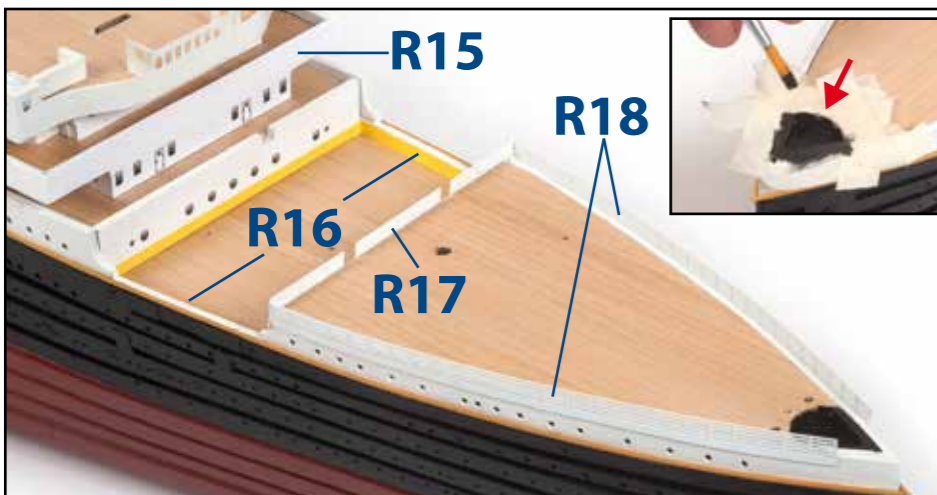
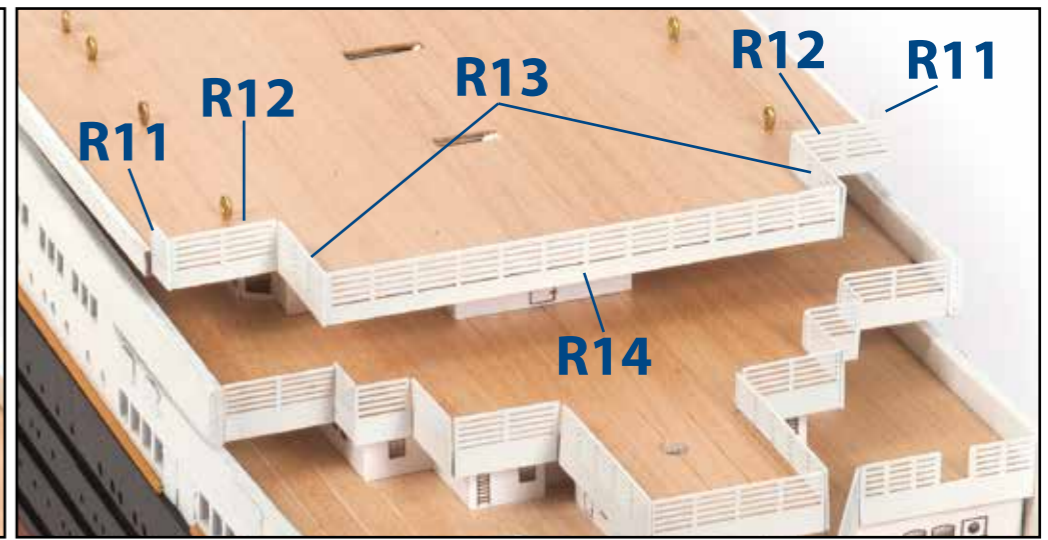
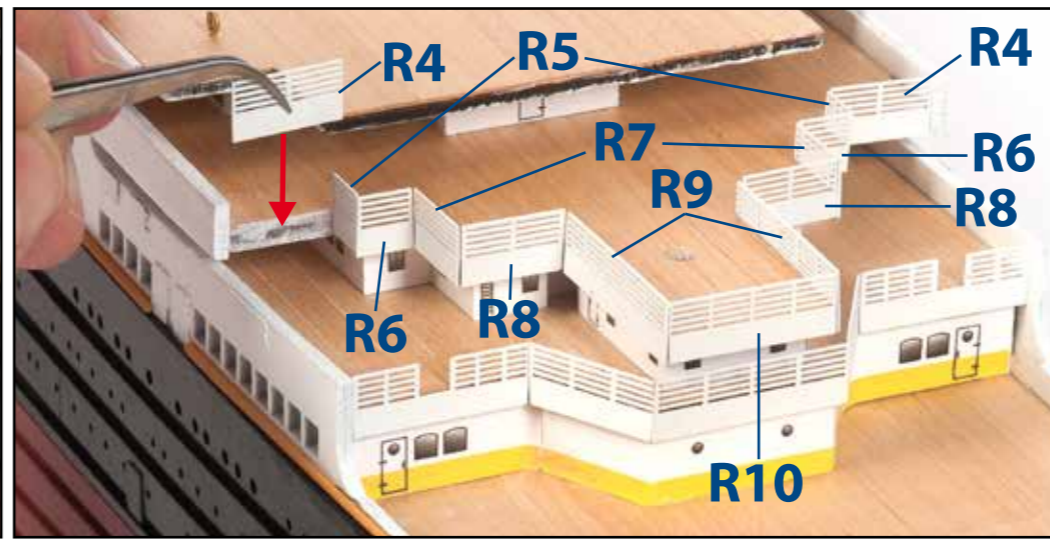
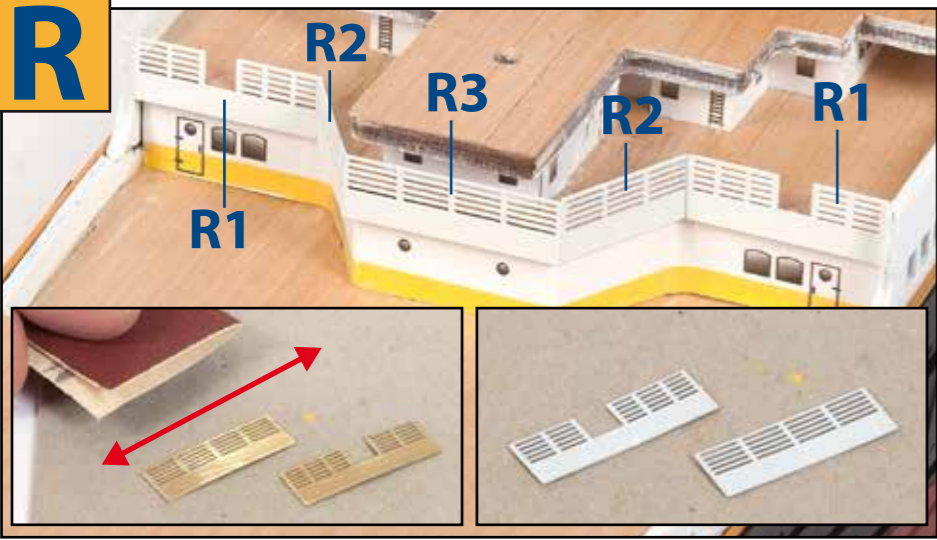

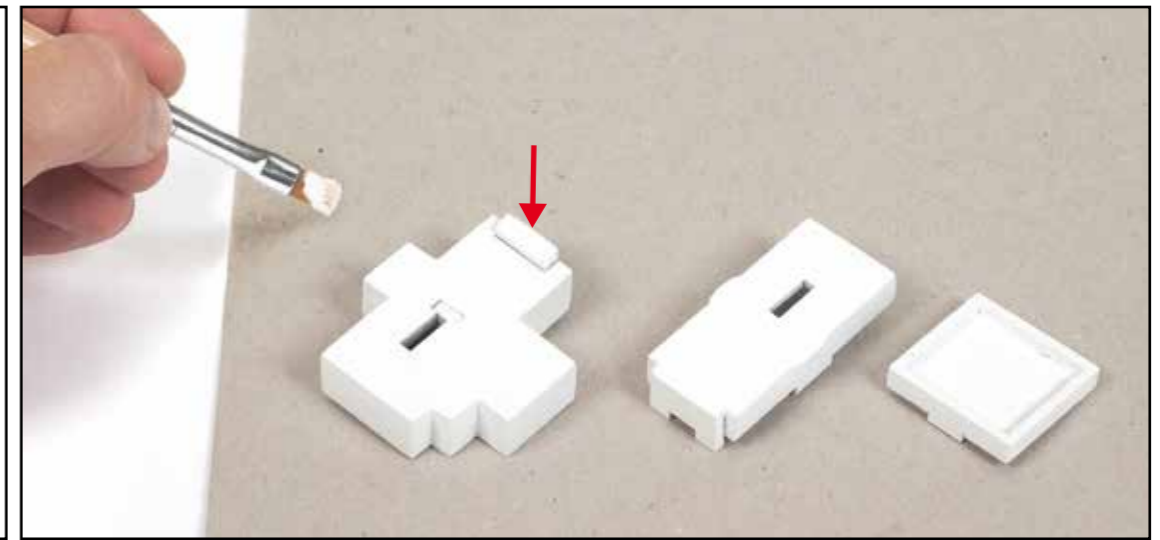
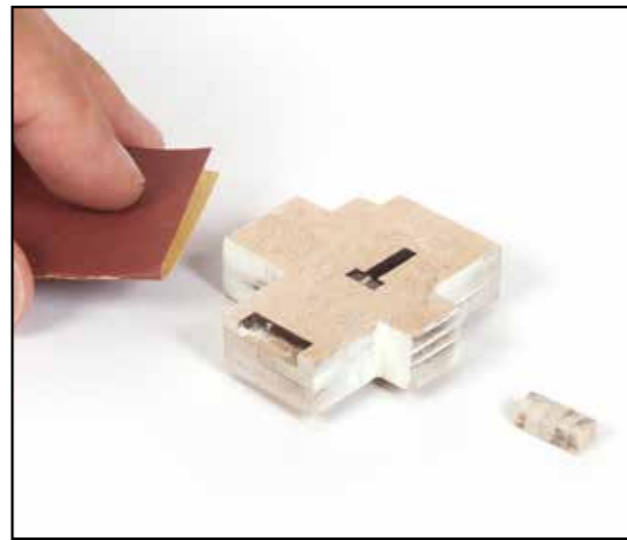
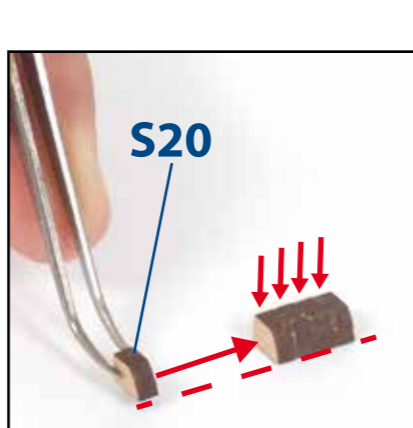
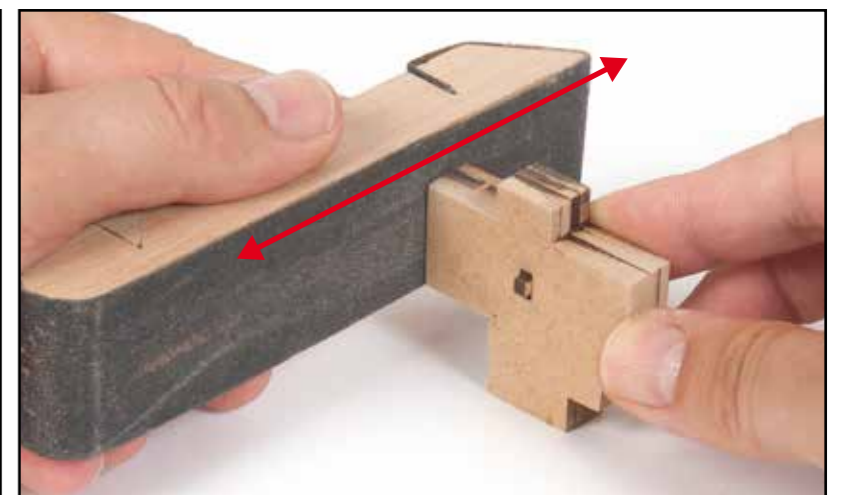
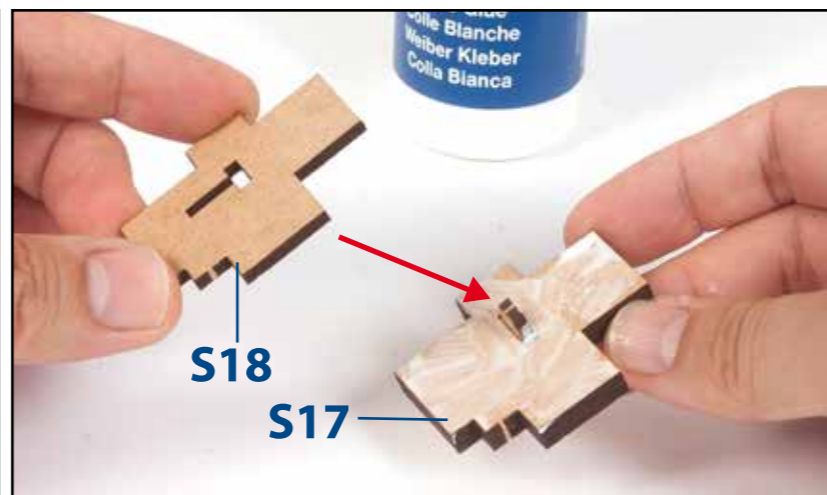
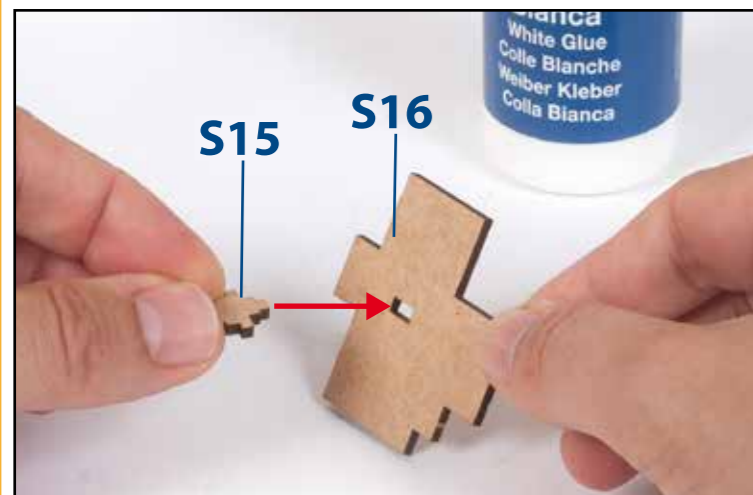
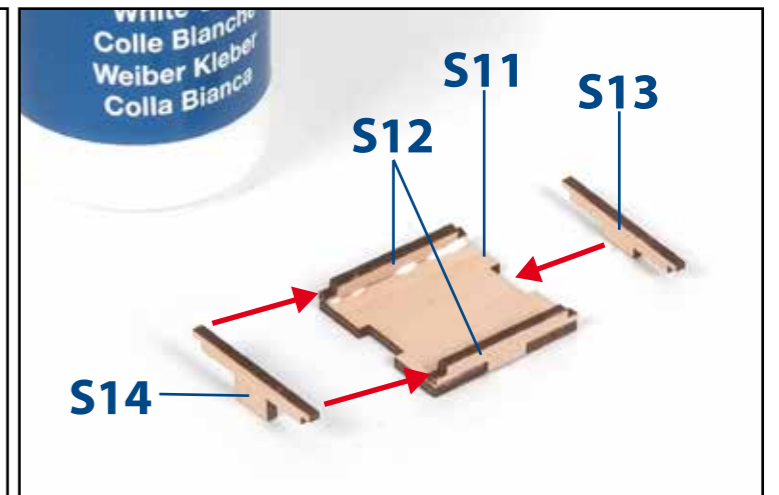
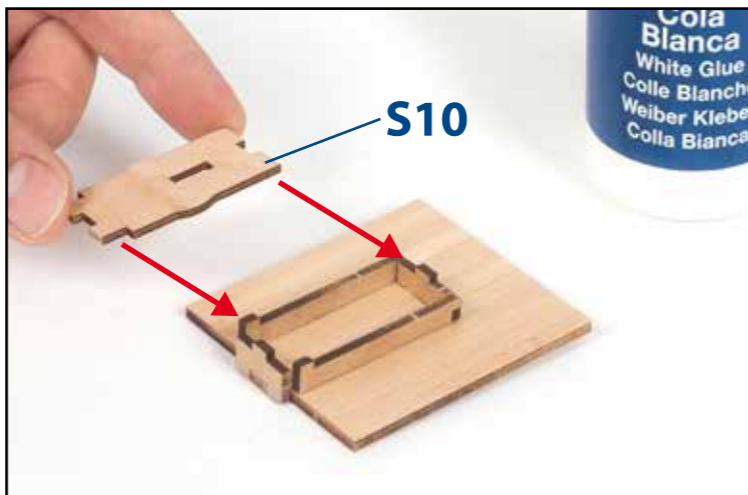
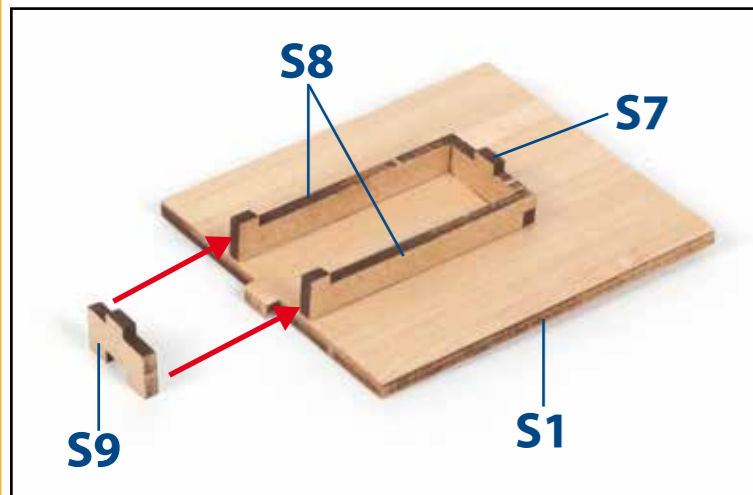
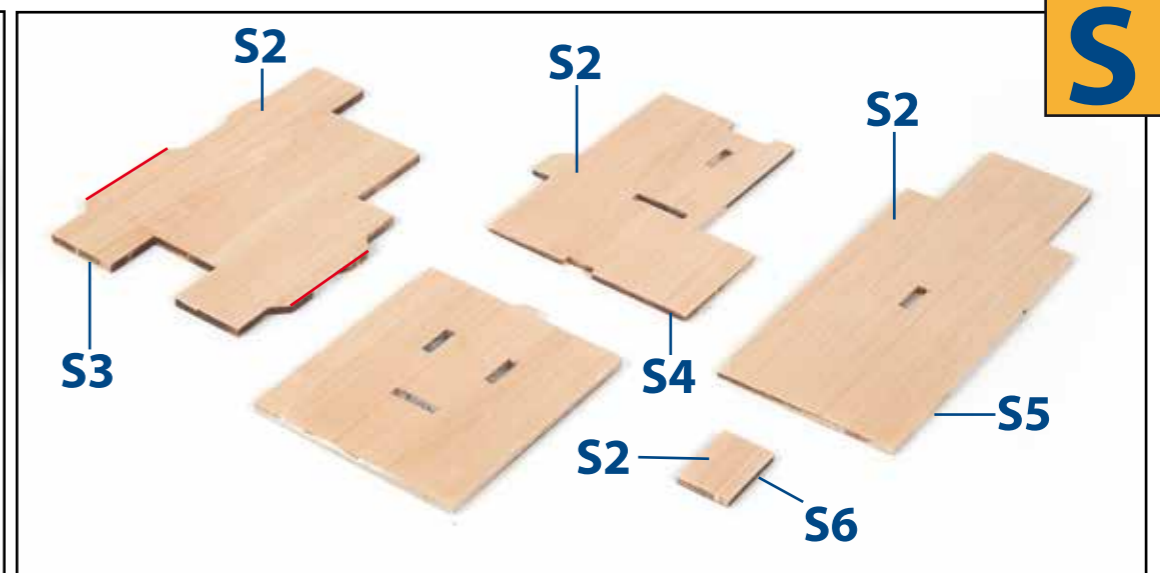
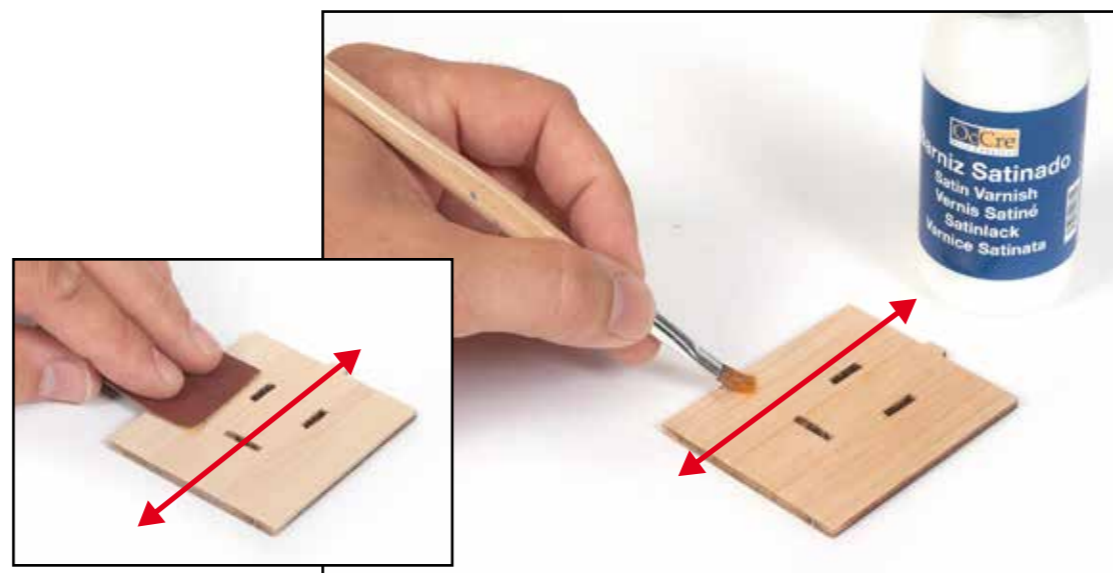
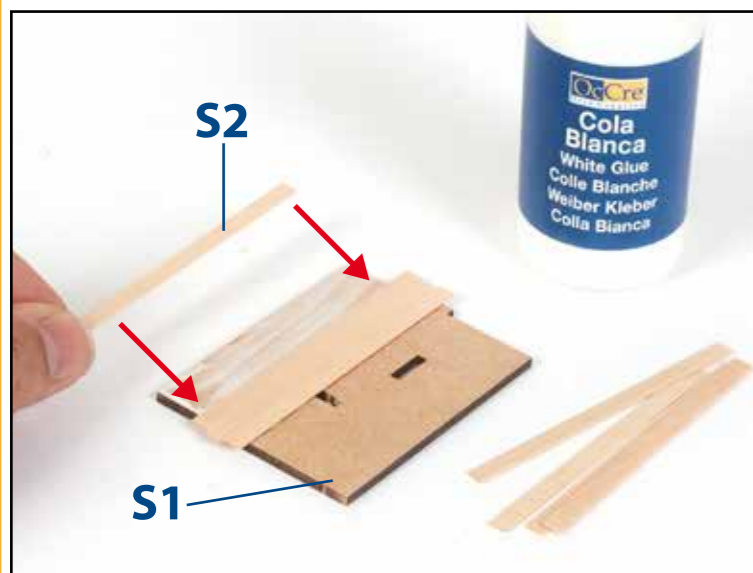

**T**

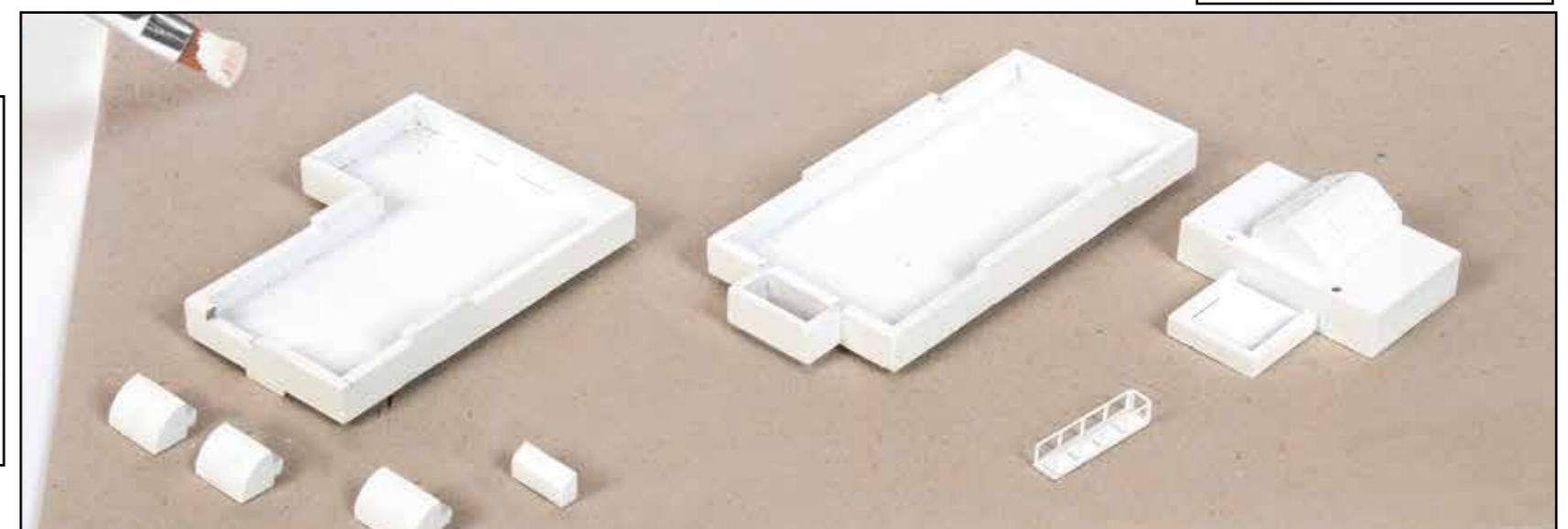
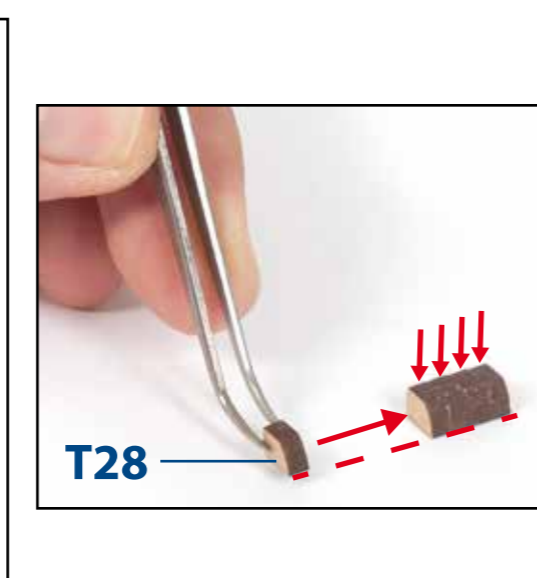
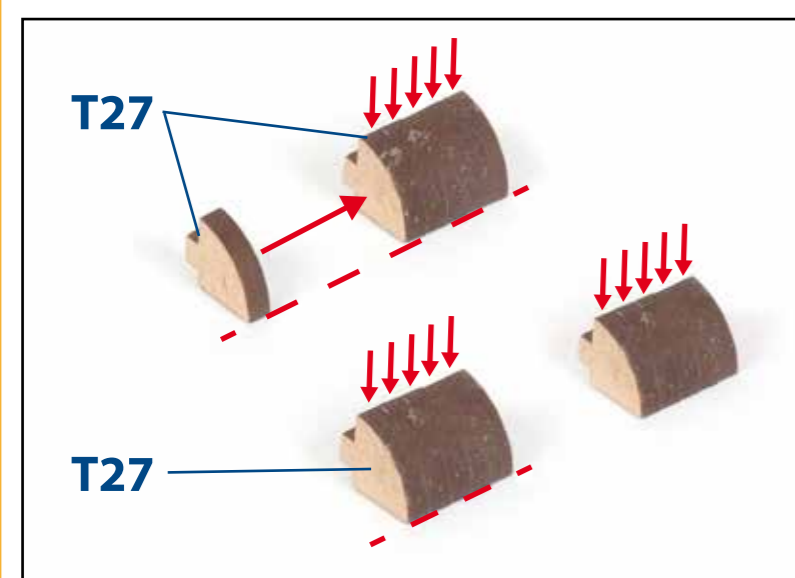
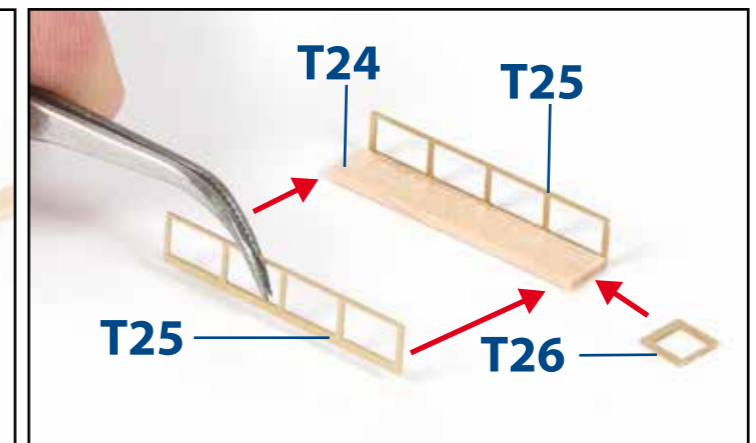
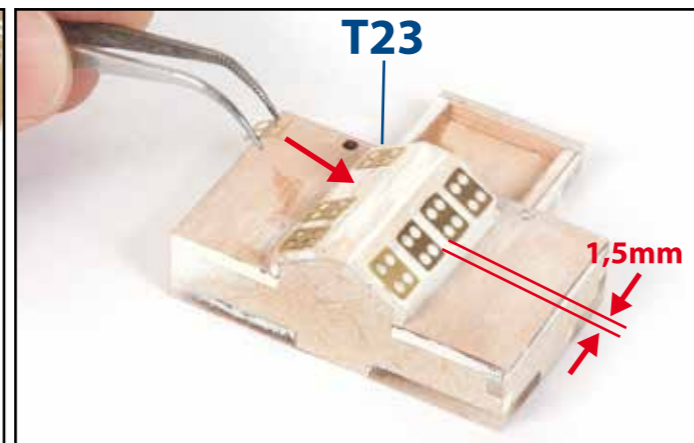
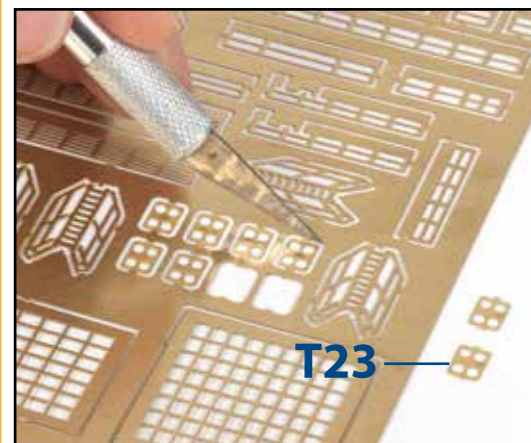
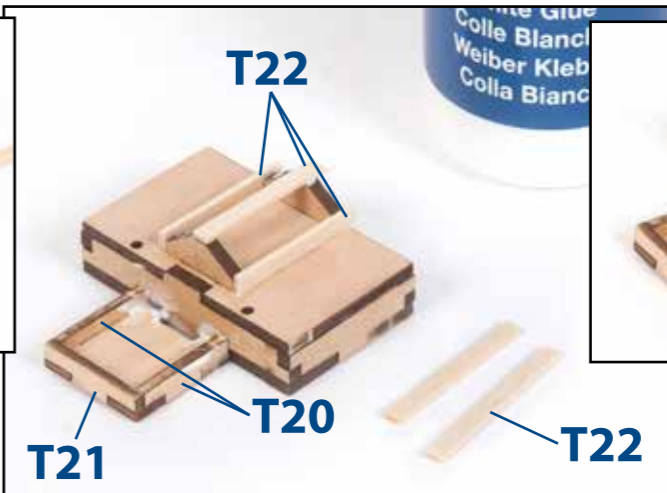
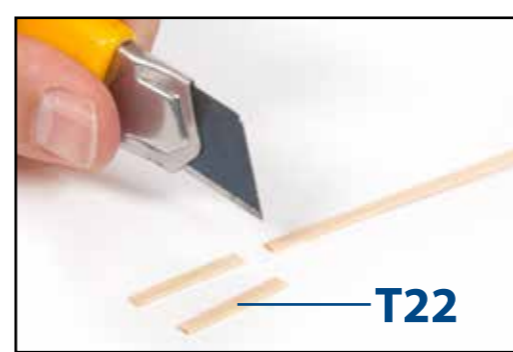
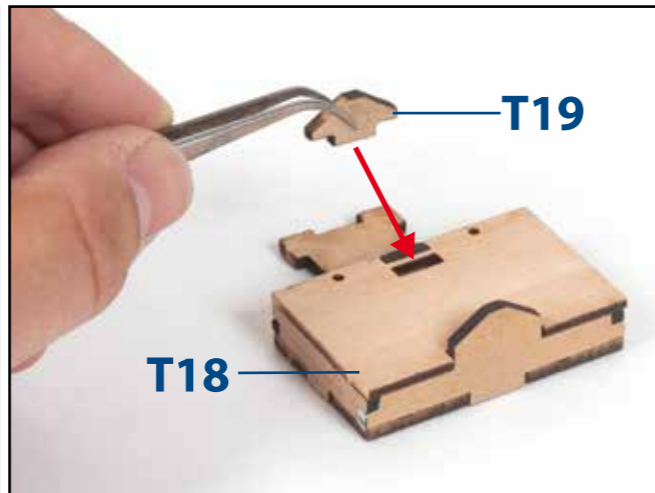
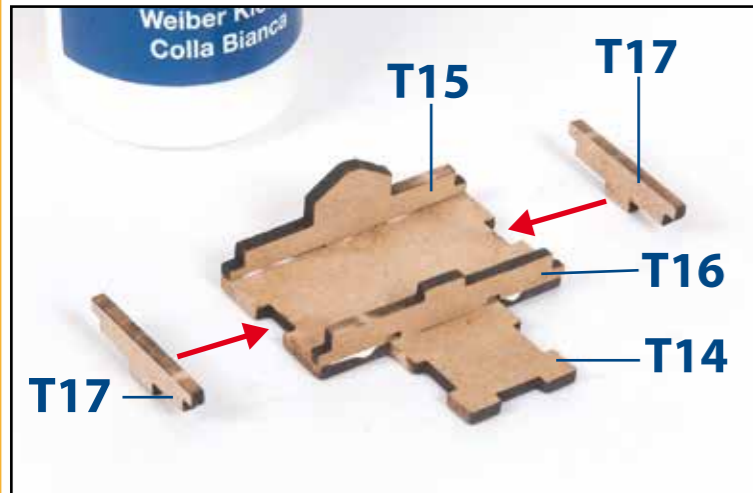
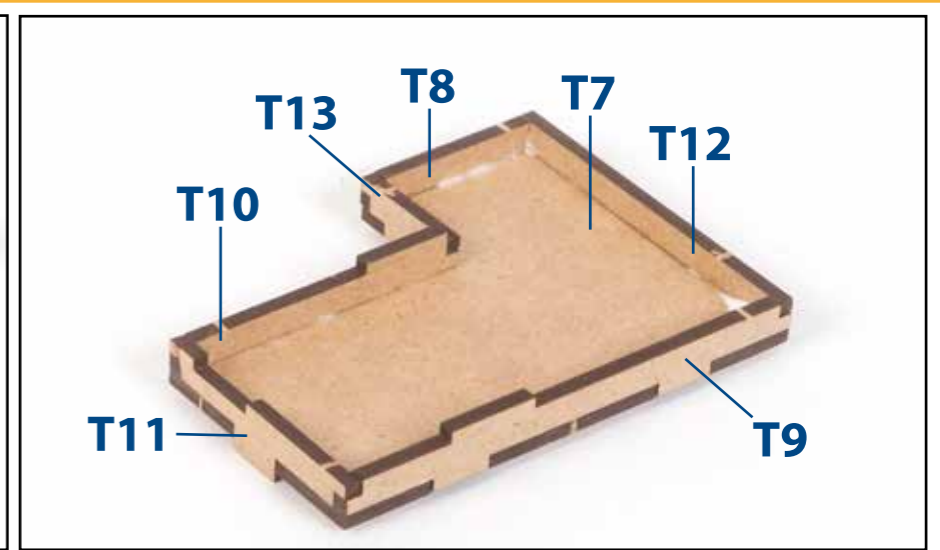
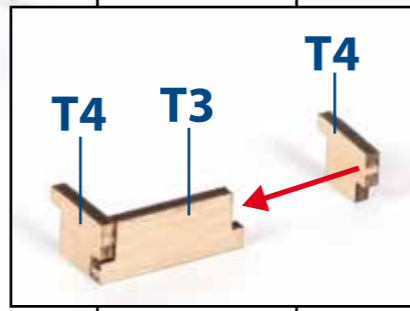
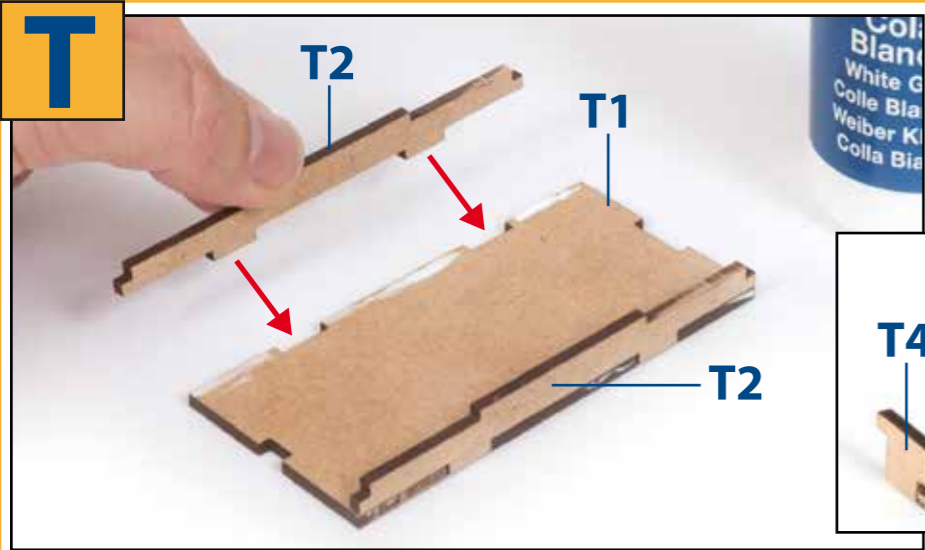



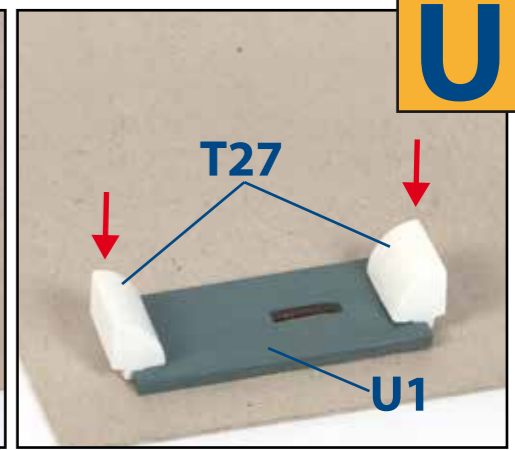
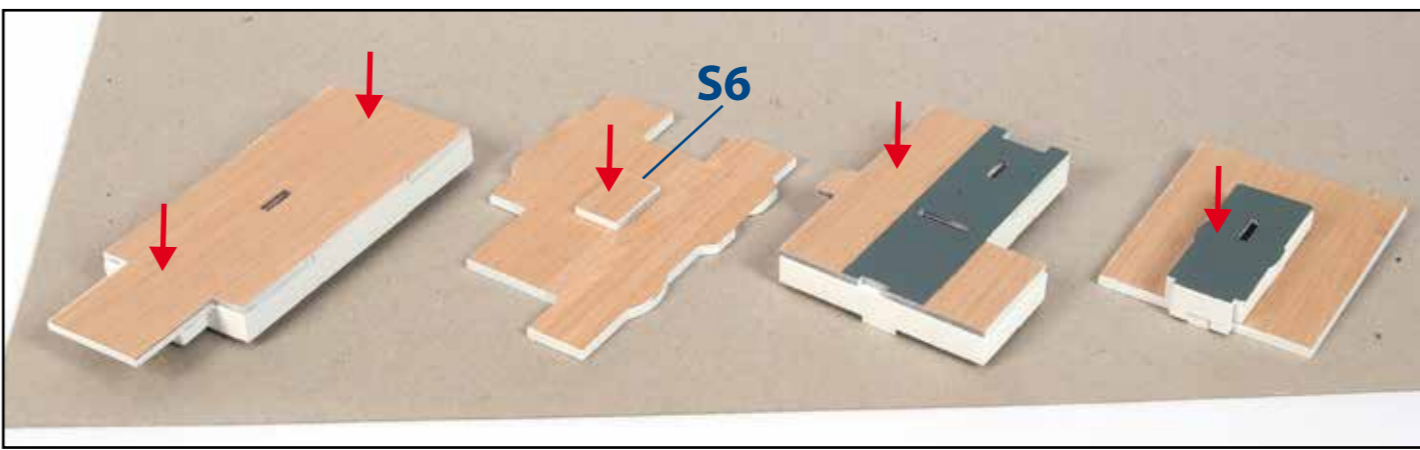
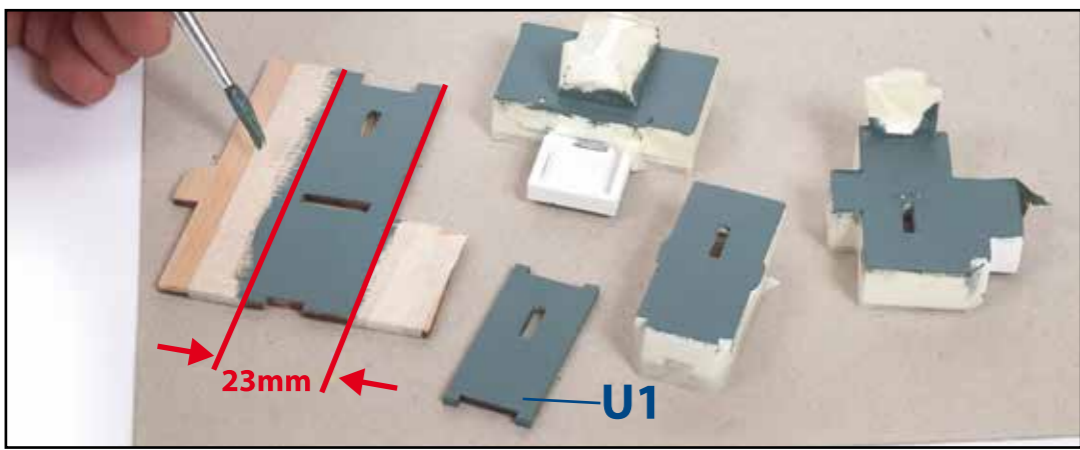

U

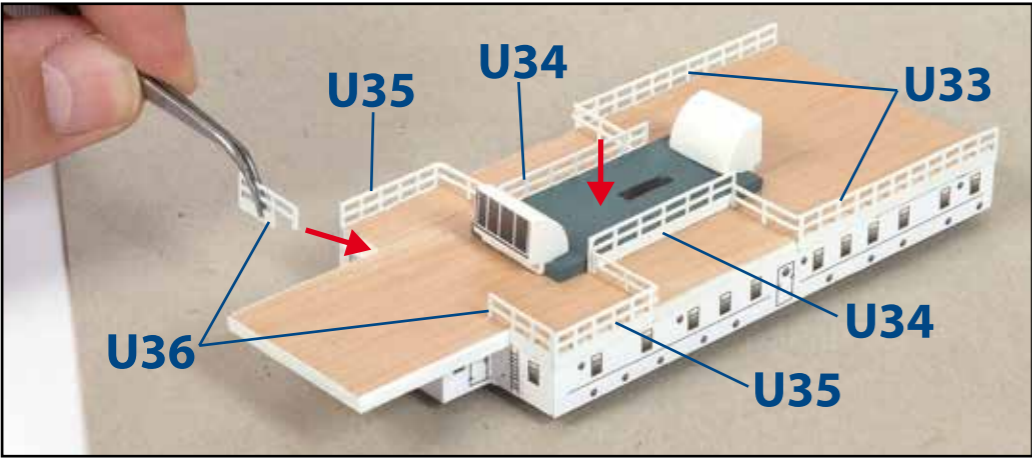
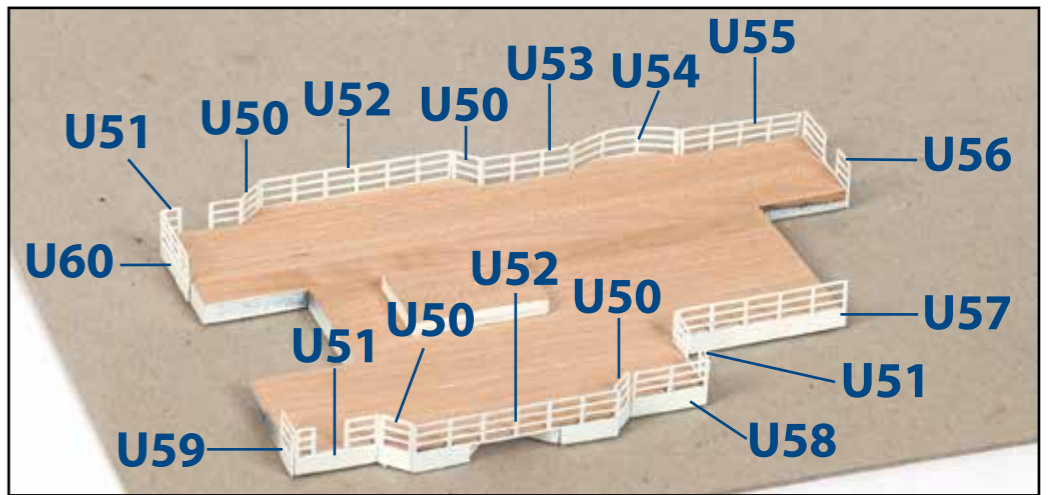
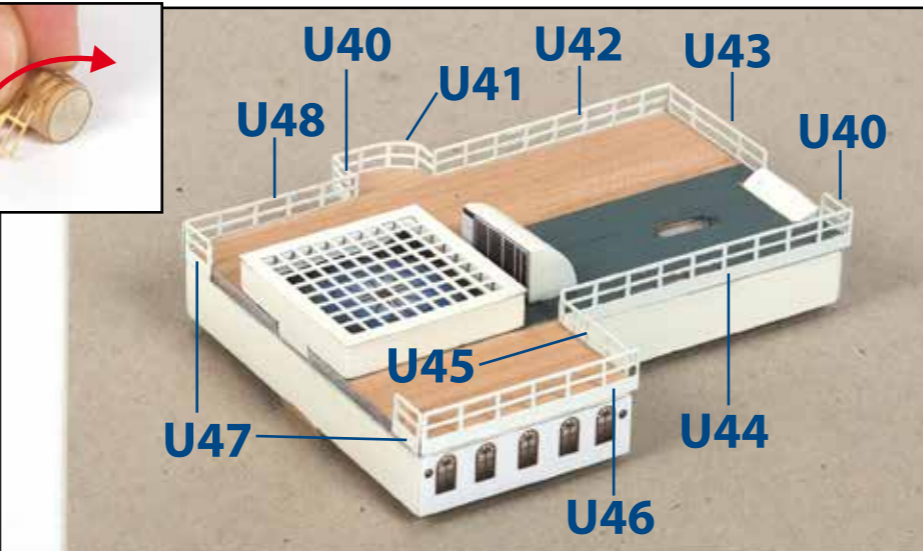
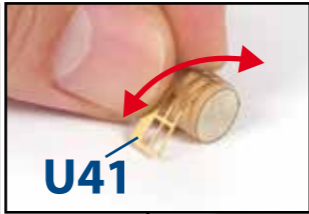
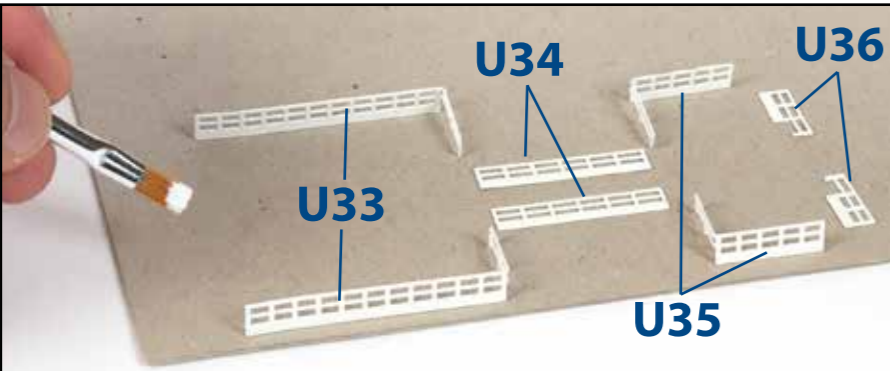
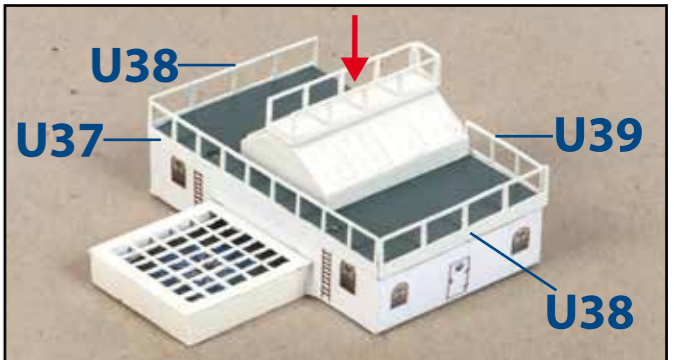
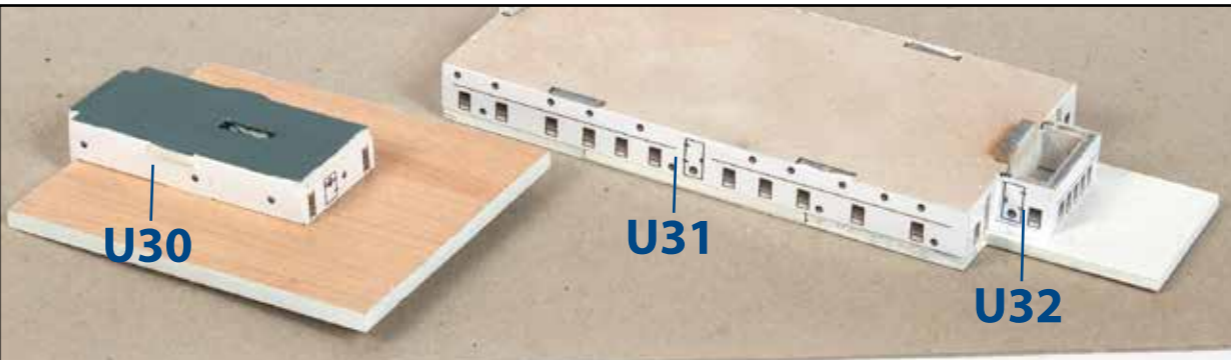
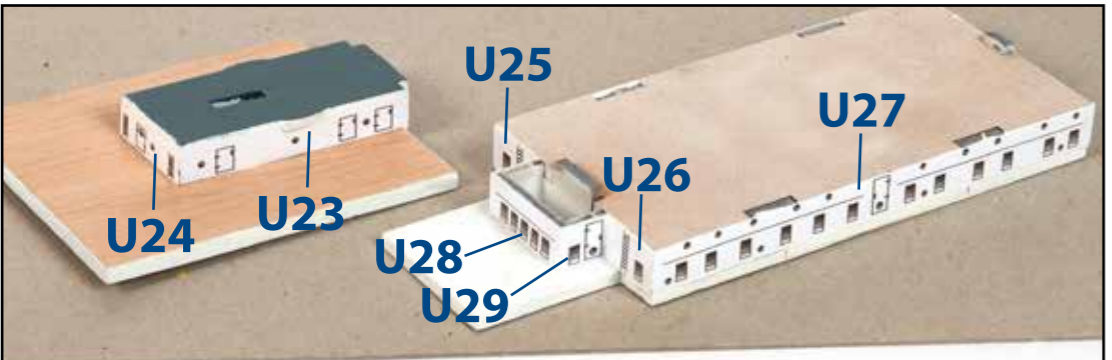
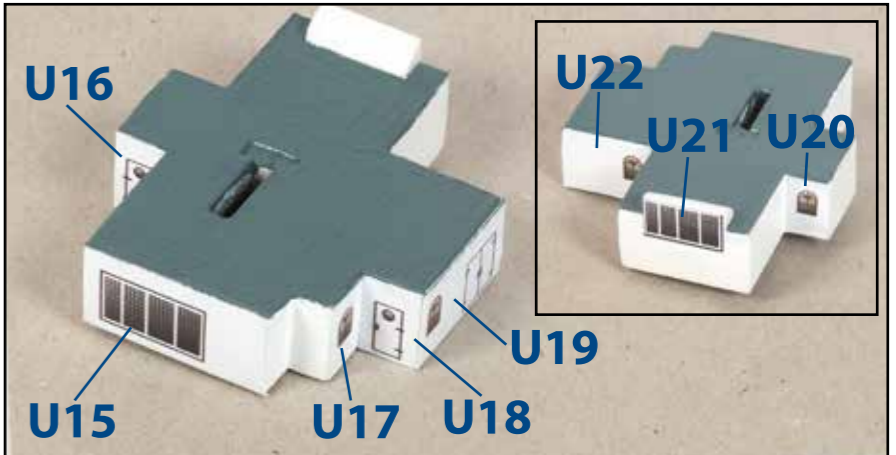
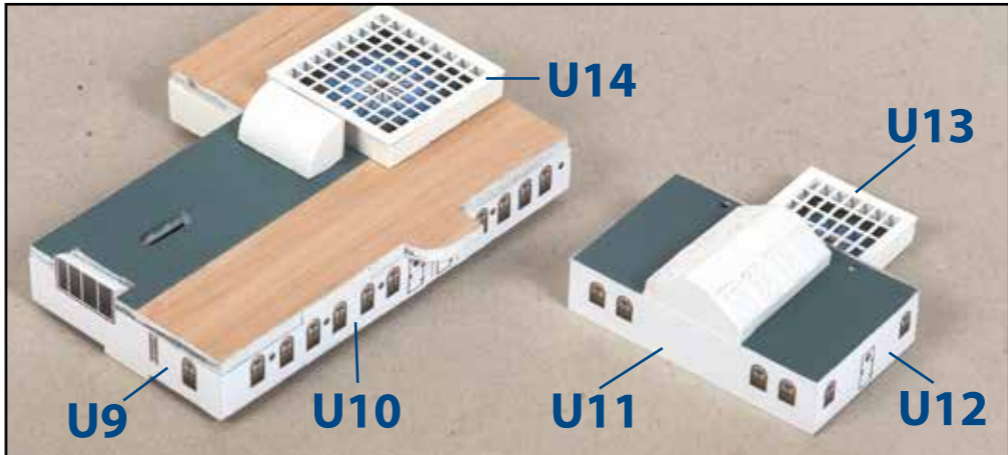
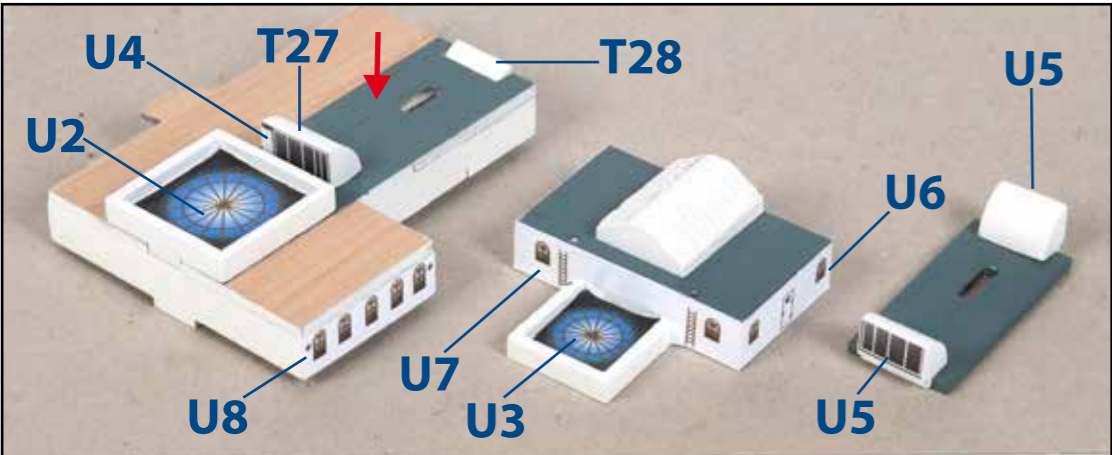

**V**

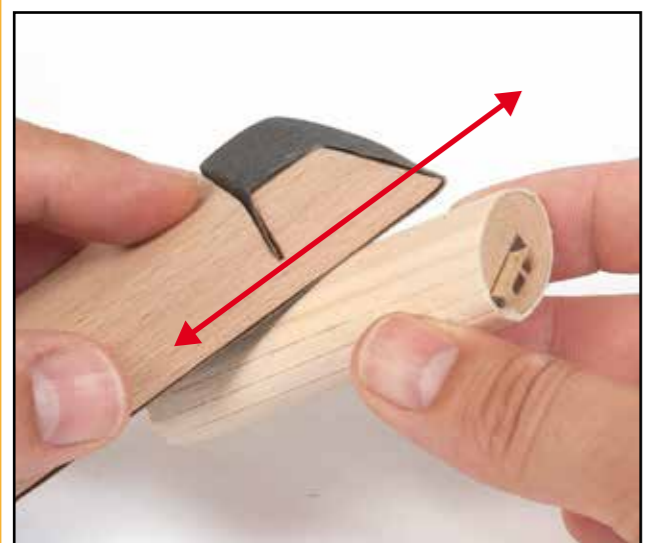
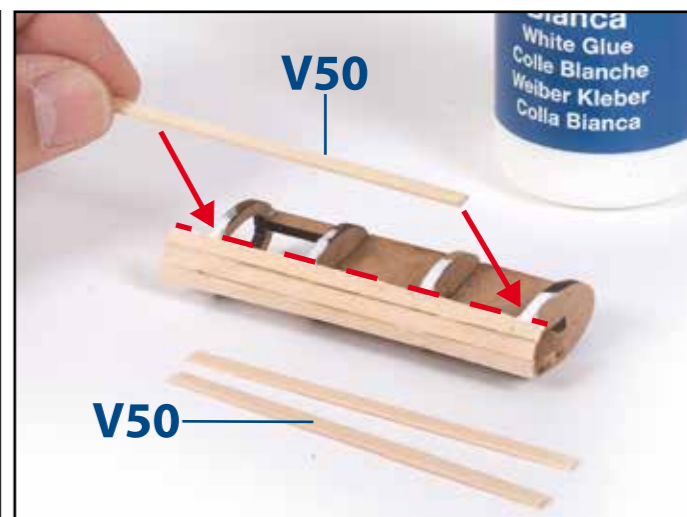
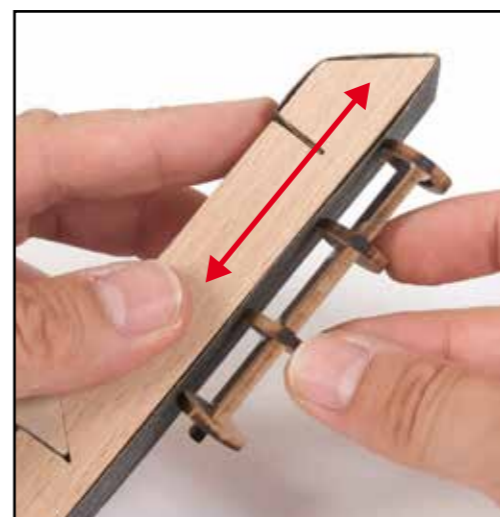
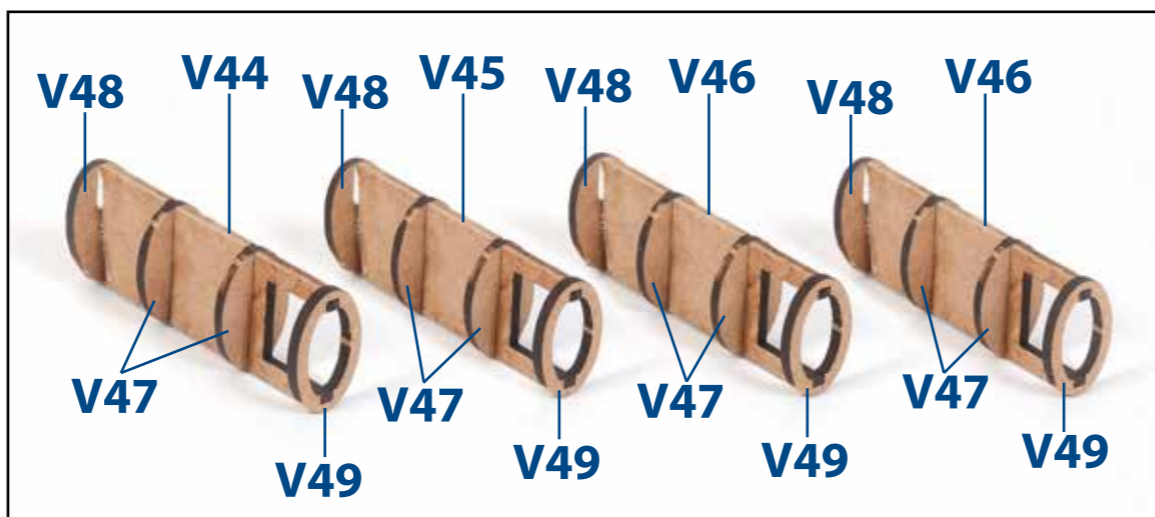
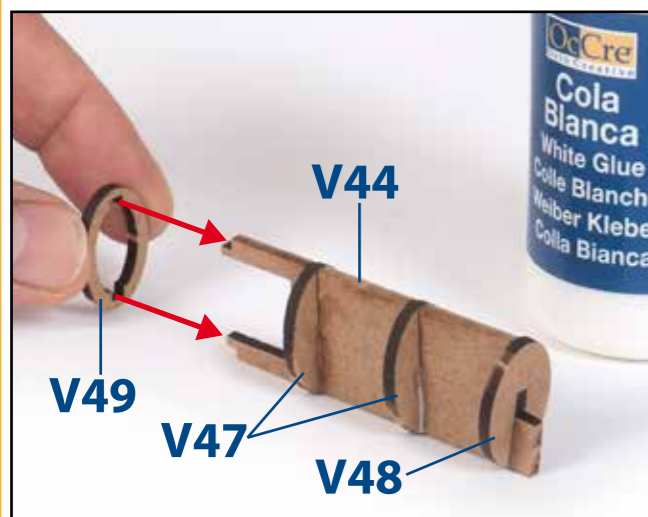
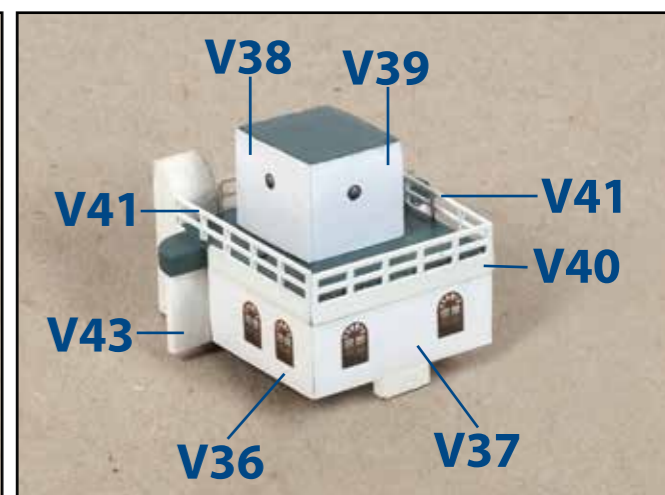
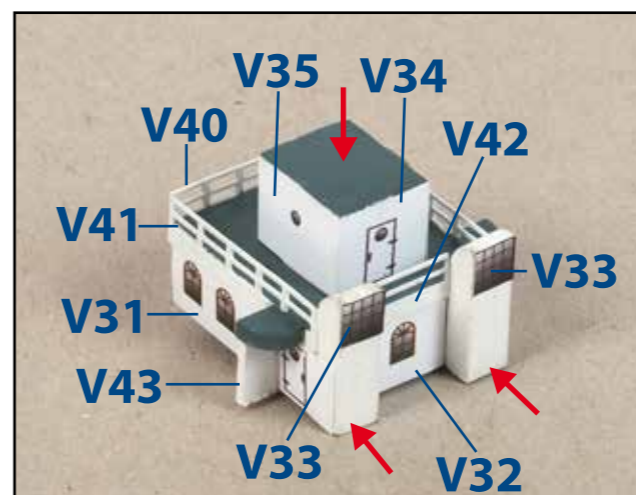
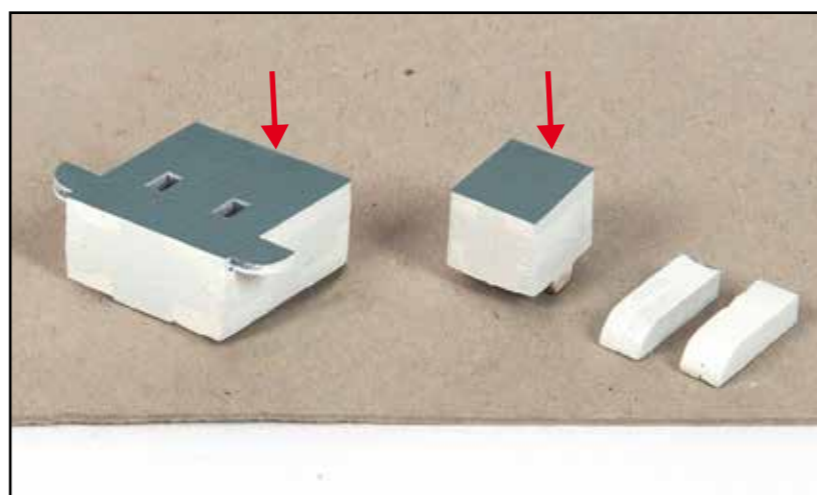
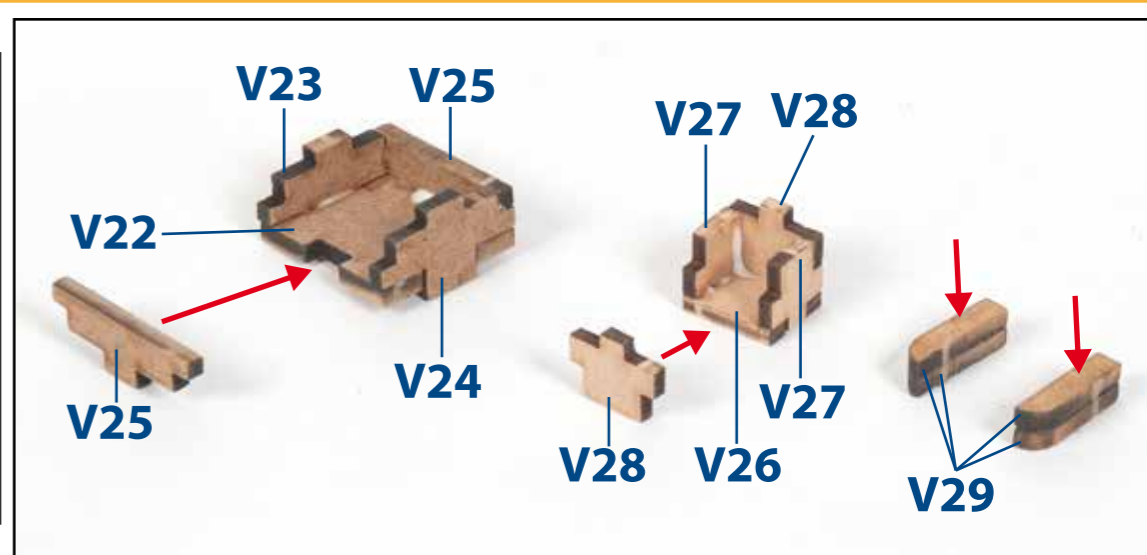
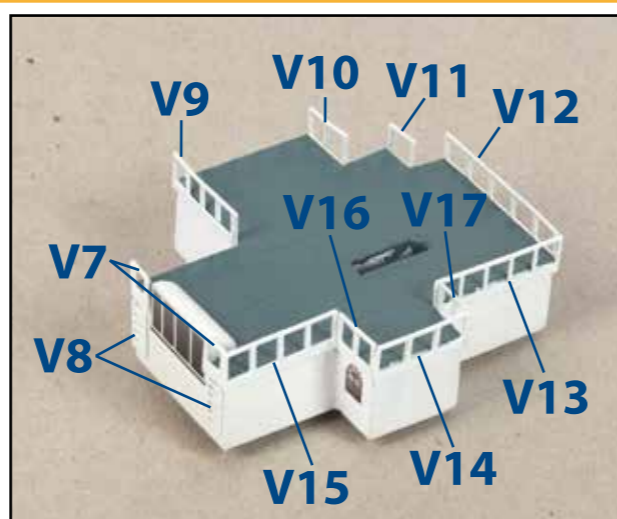
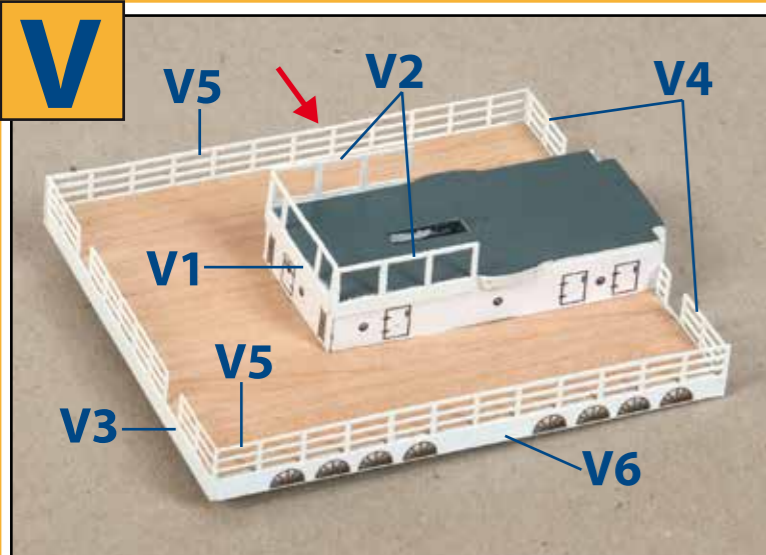

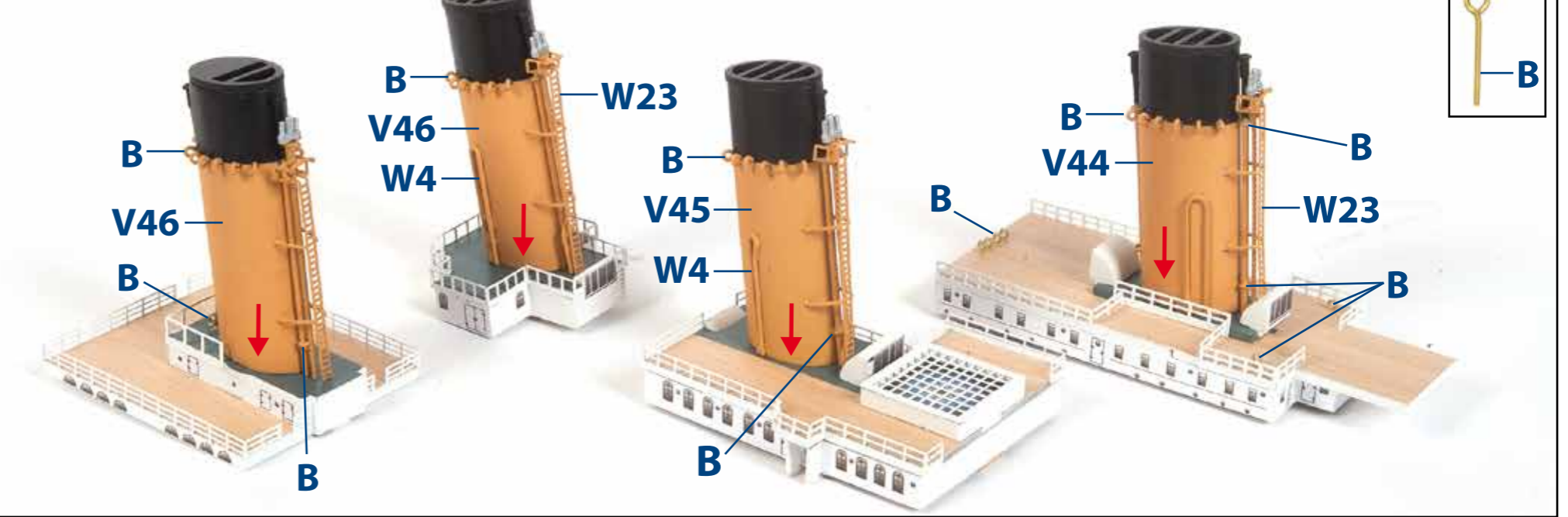
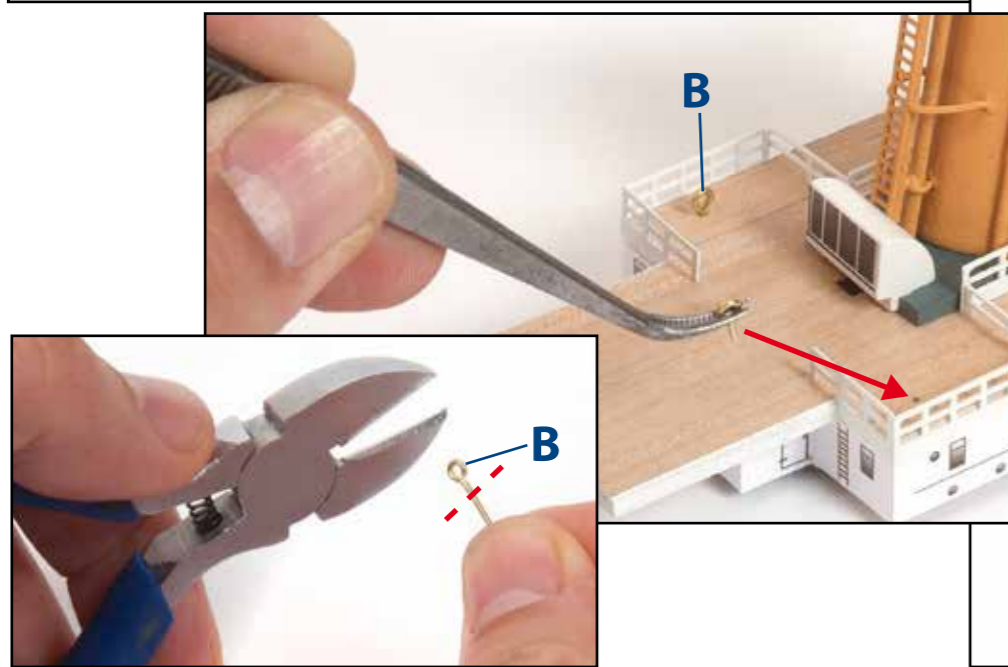
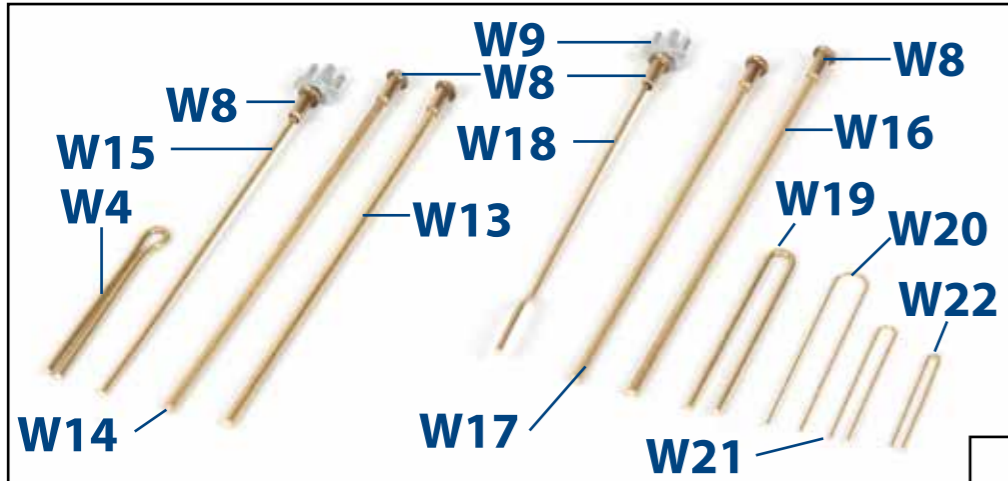
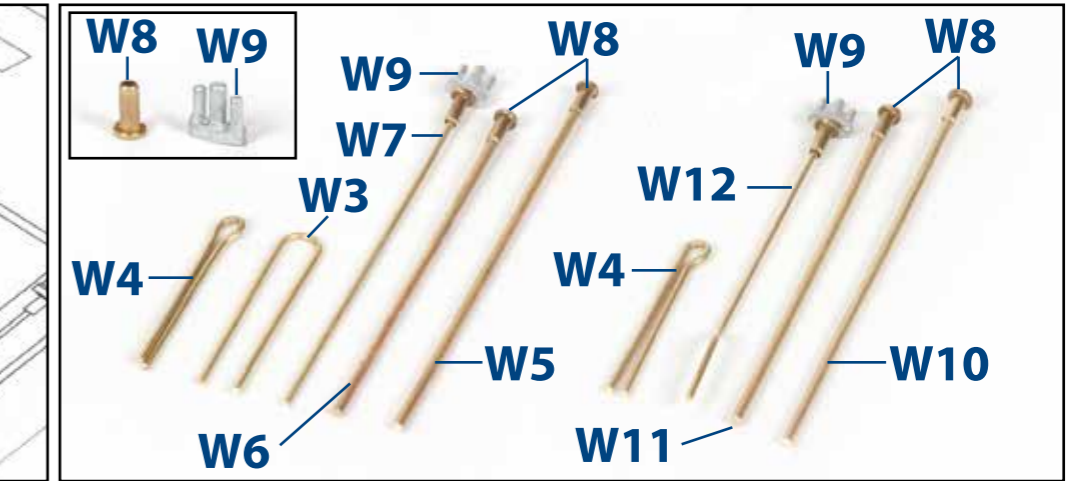
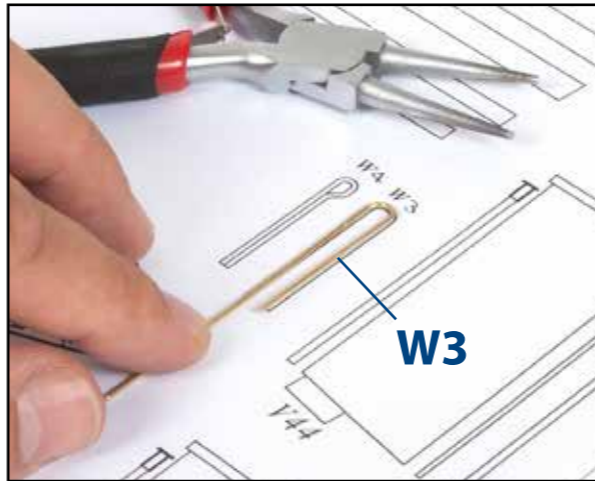
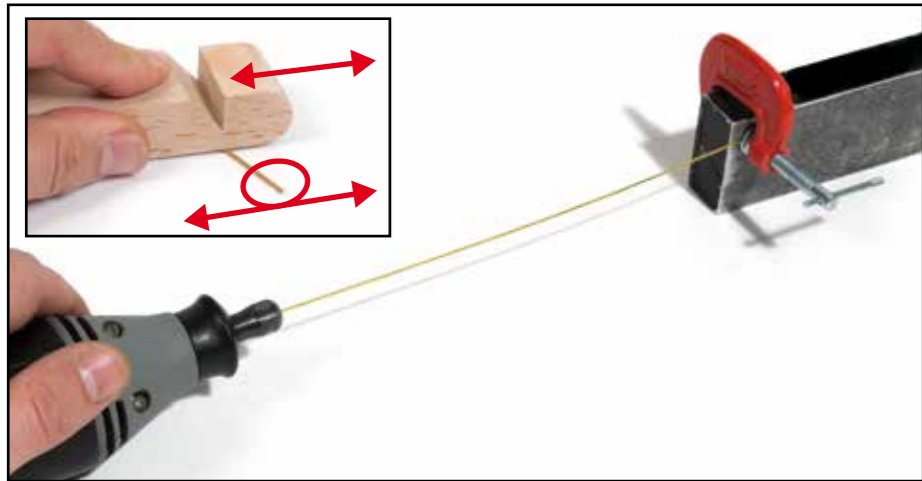
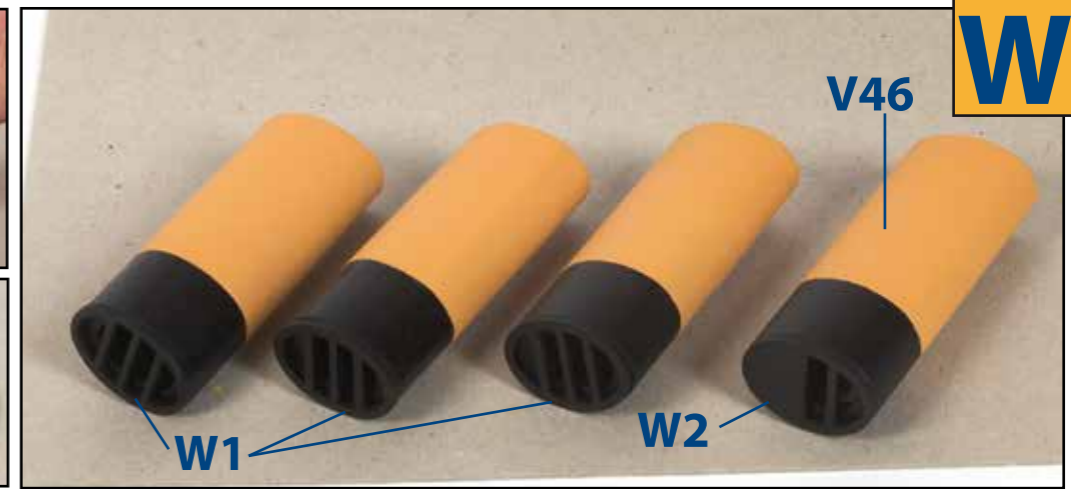
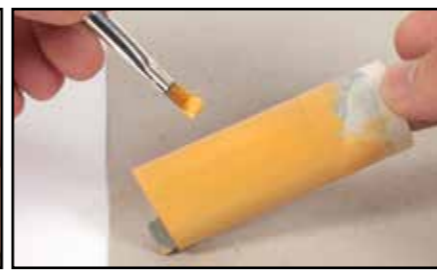
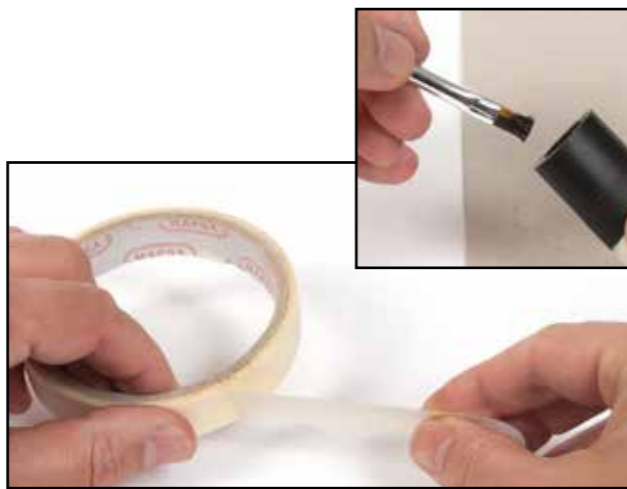

**X**

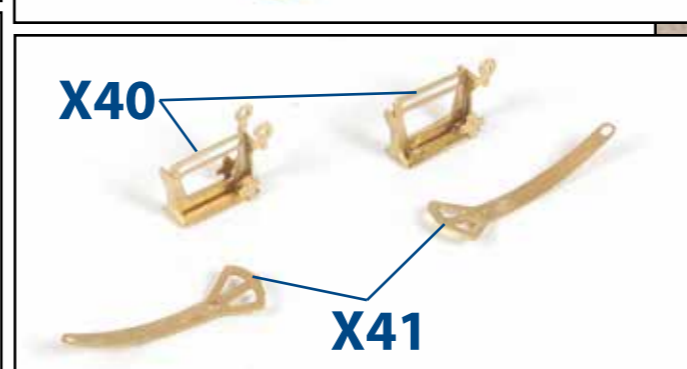
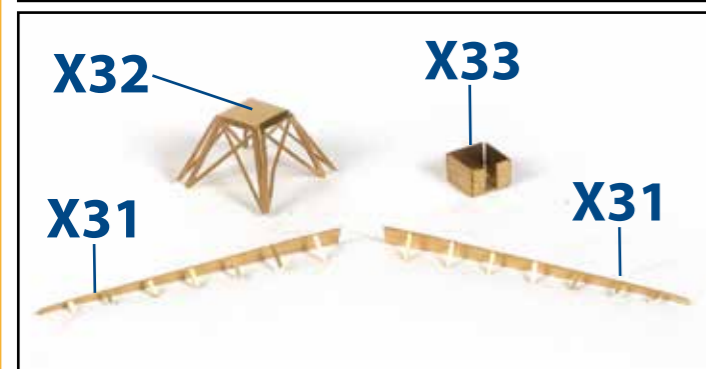
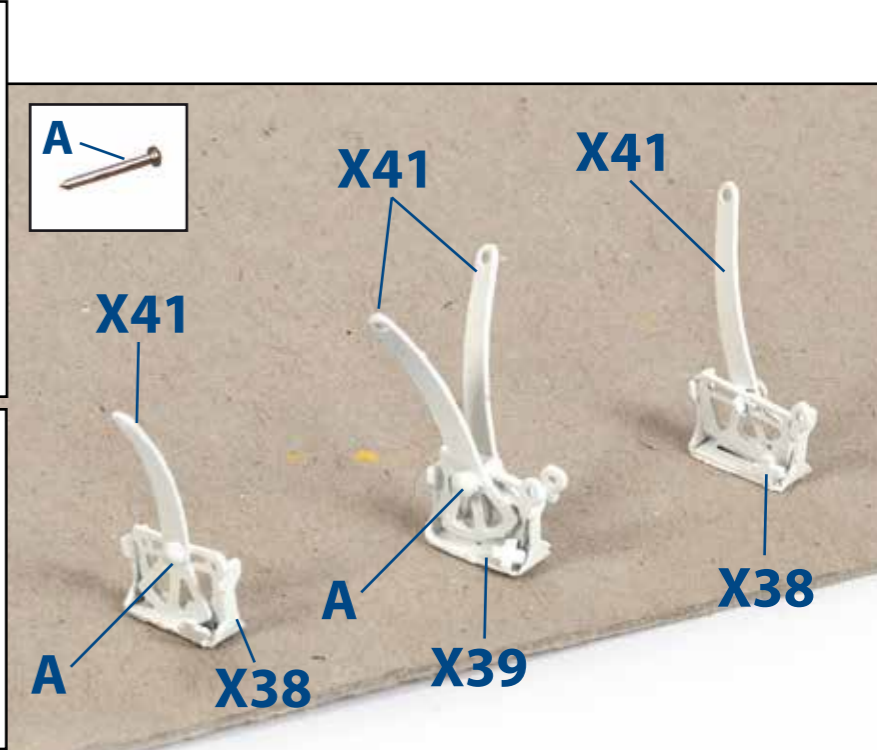
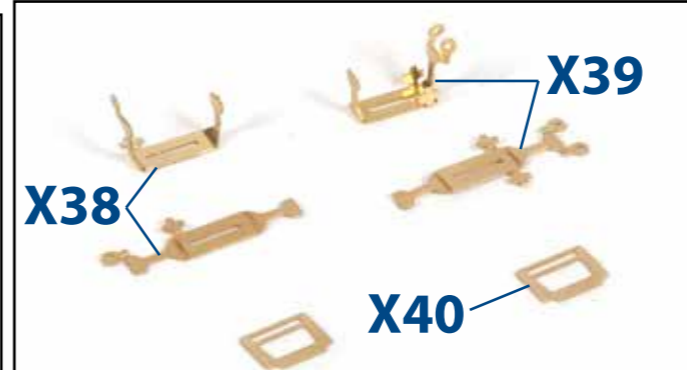
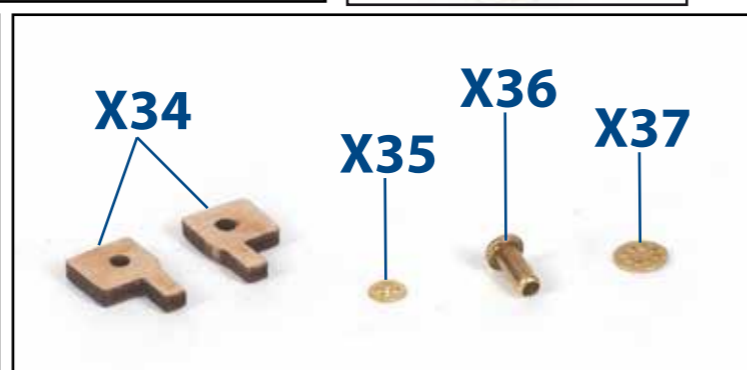
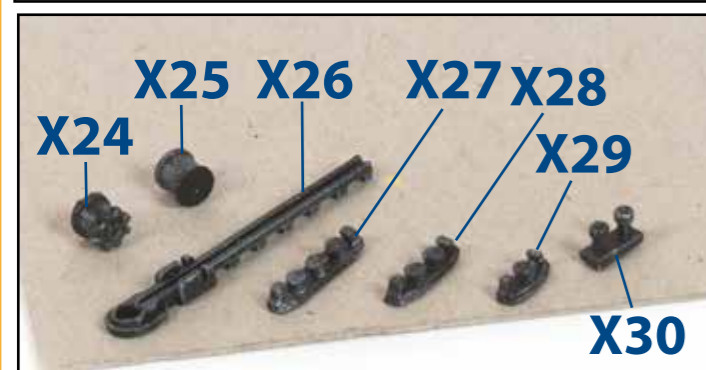
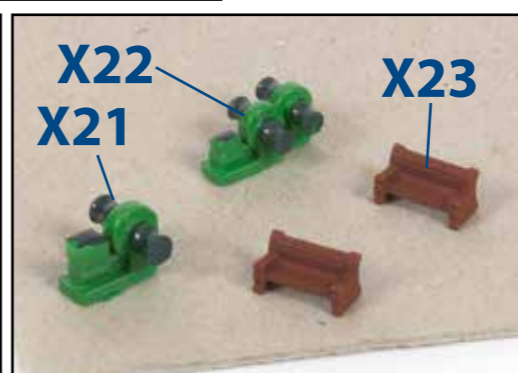
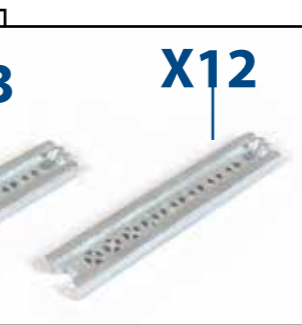
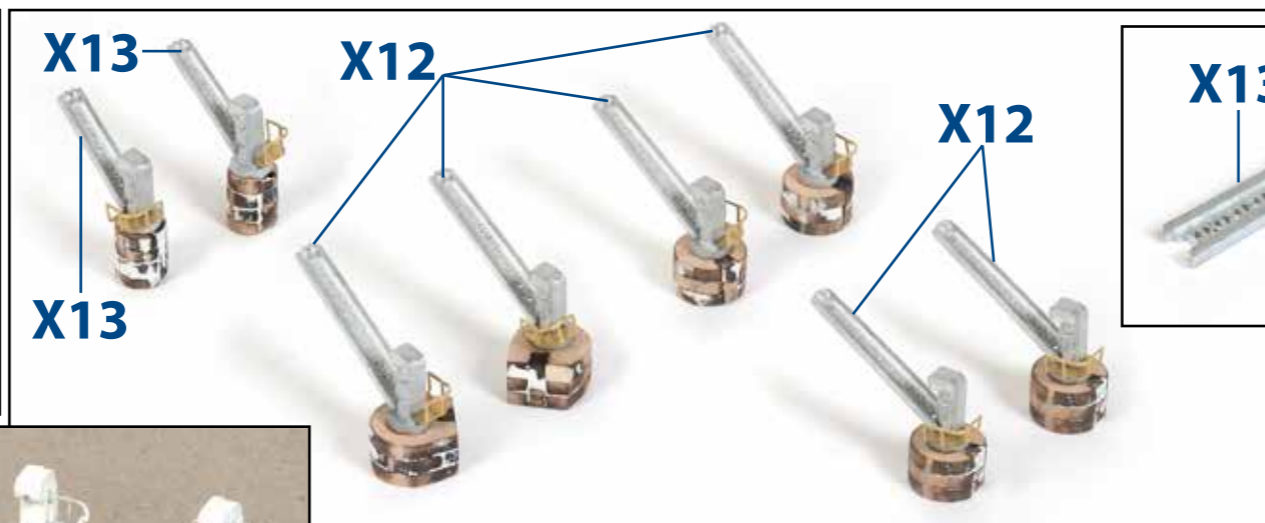
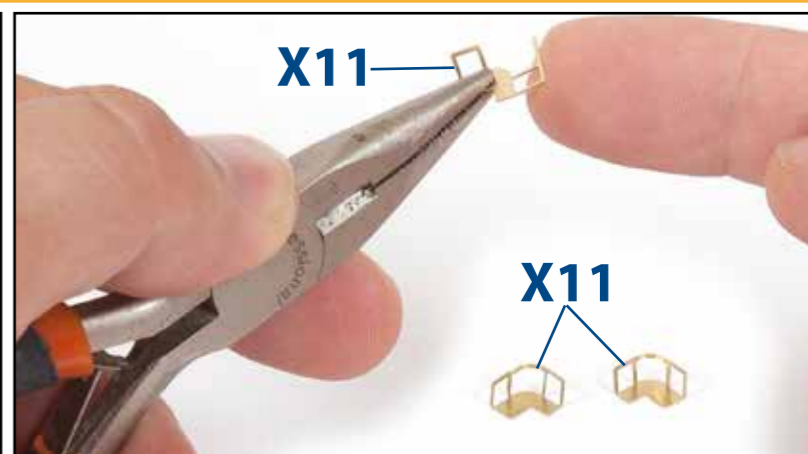
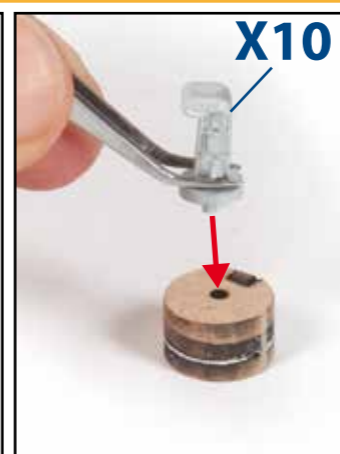
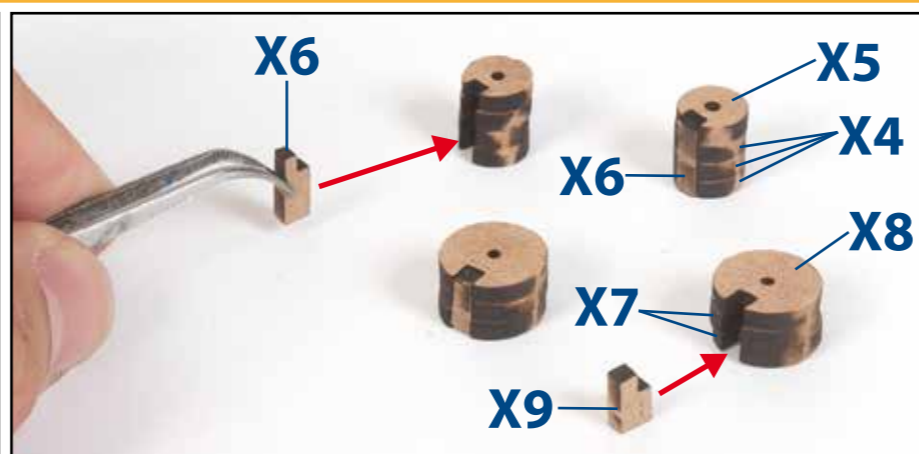
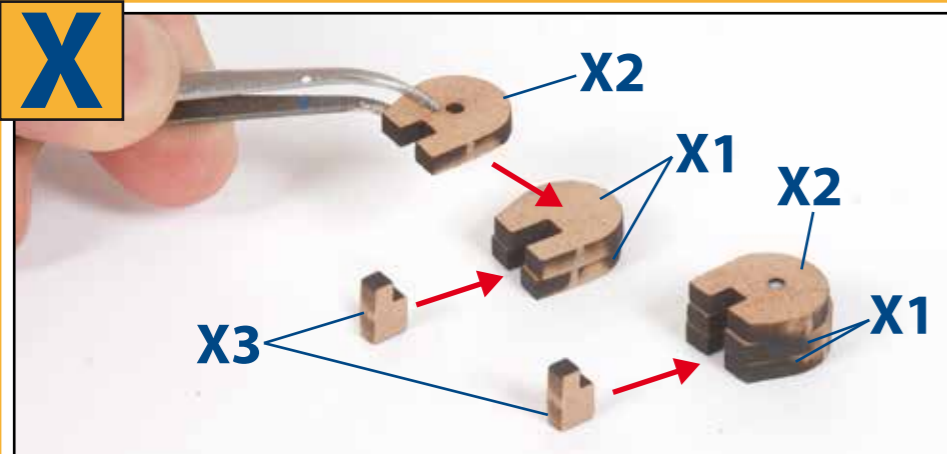

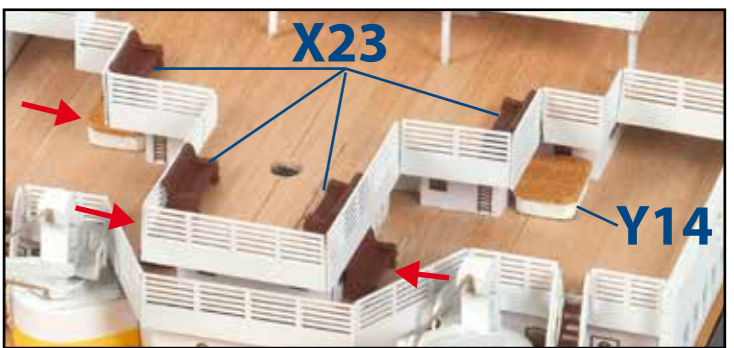
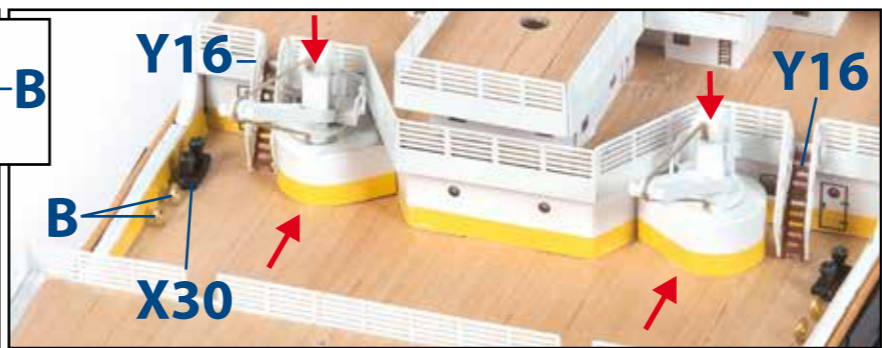
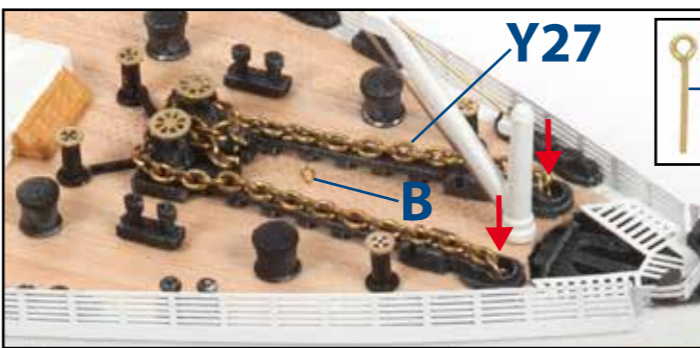
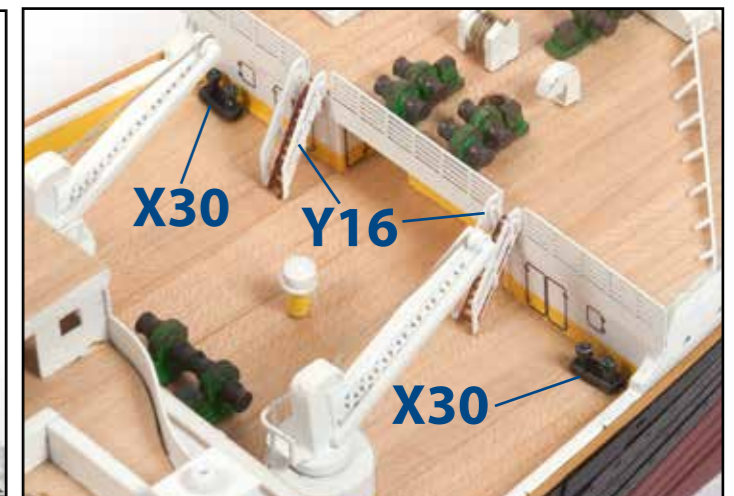
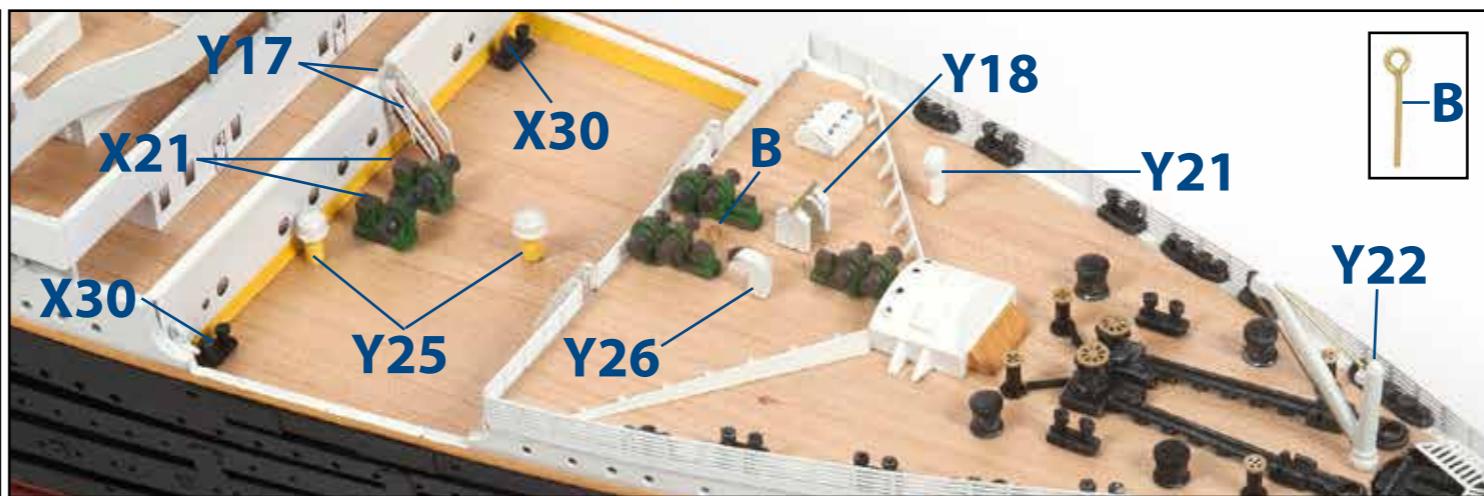
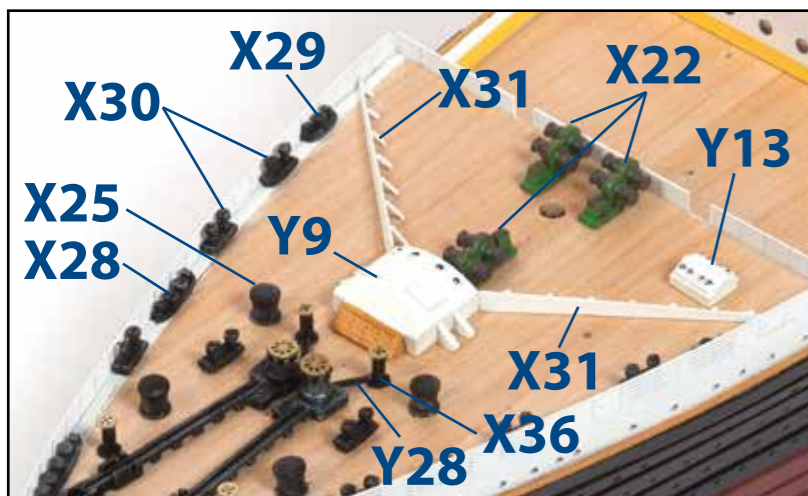
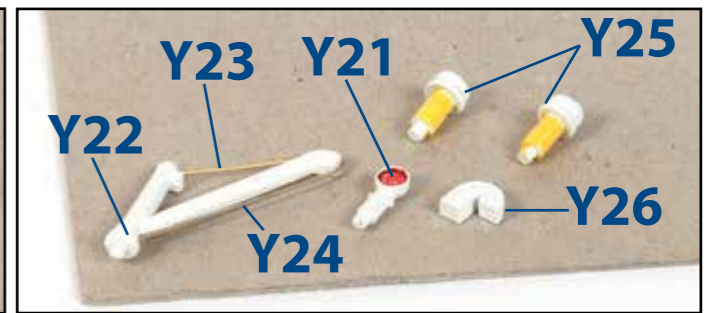
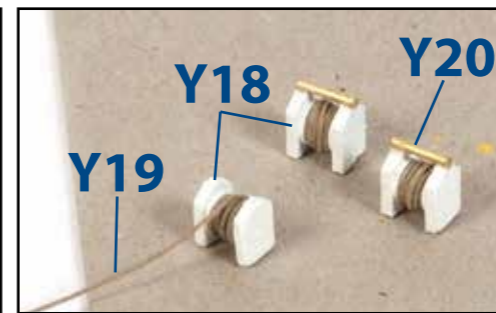
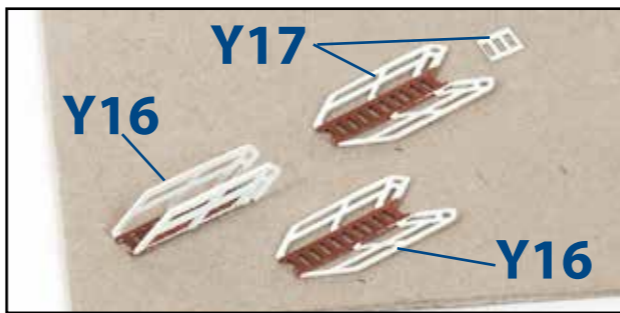
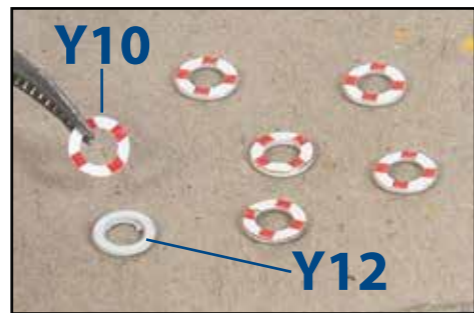
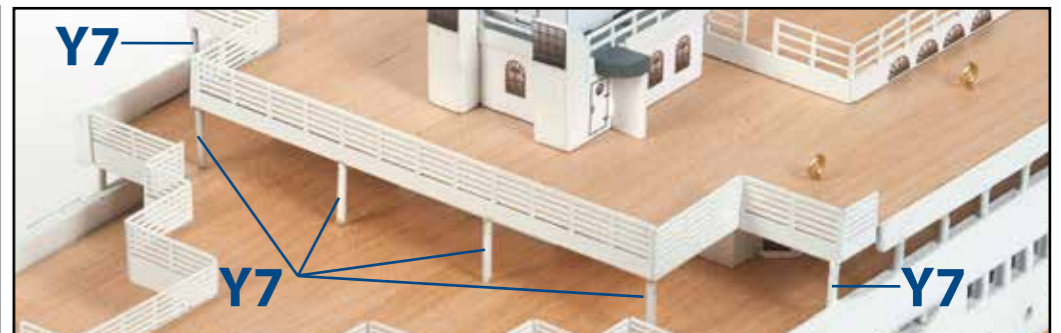
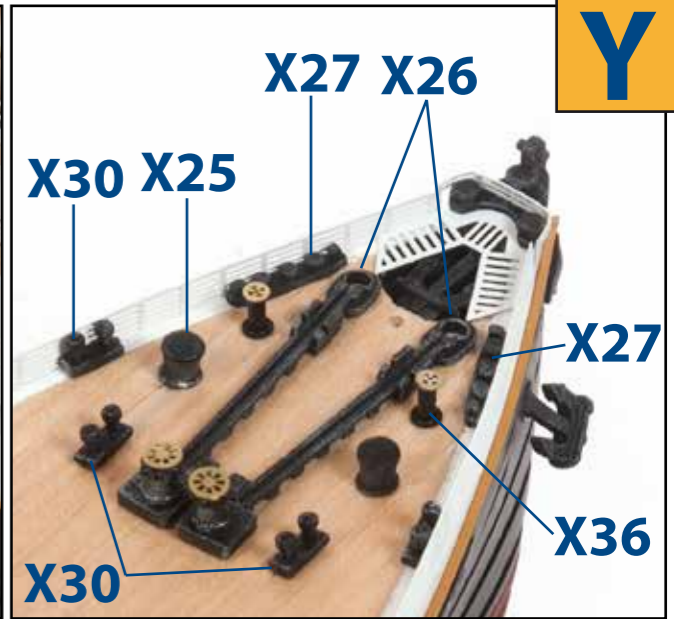
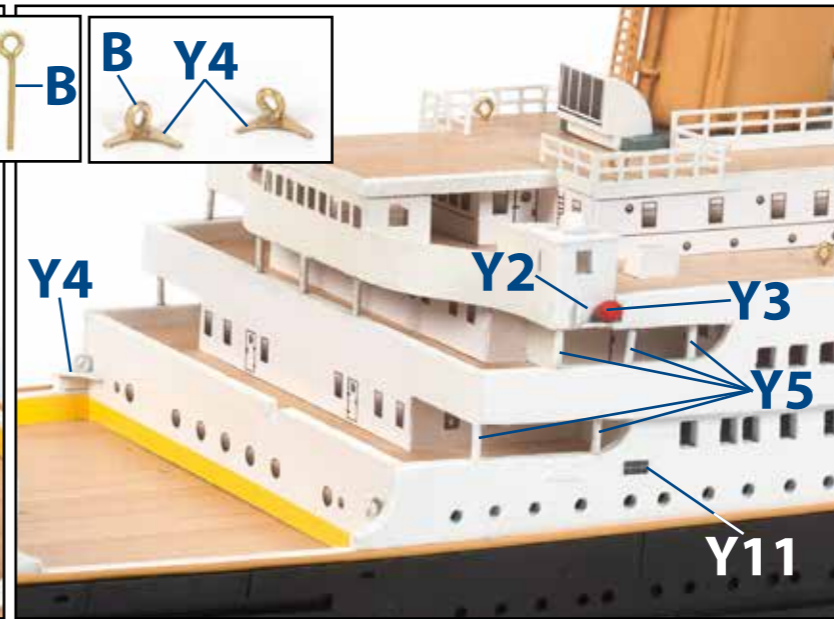
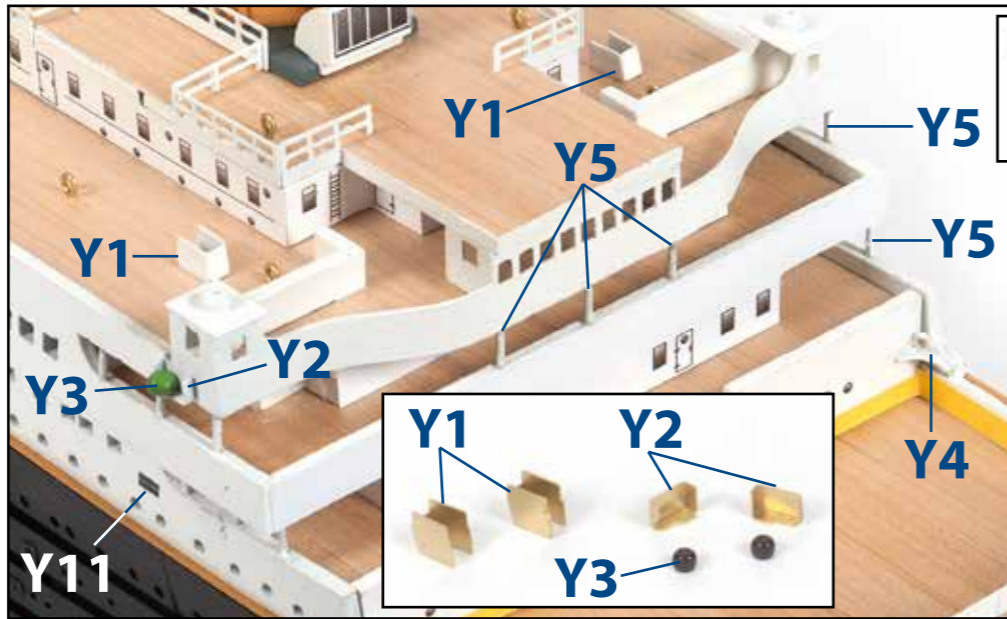
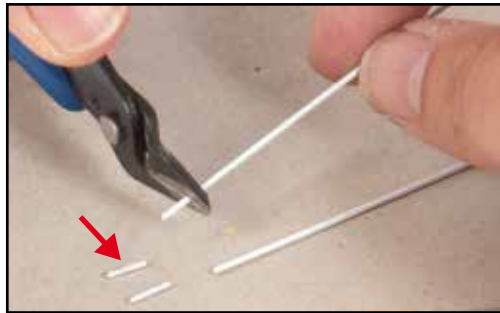
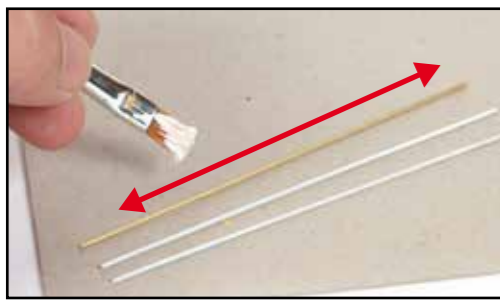

# Z

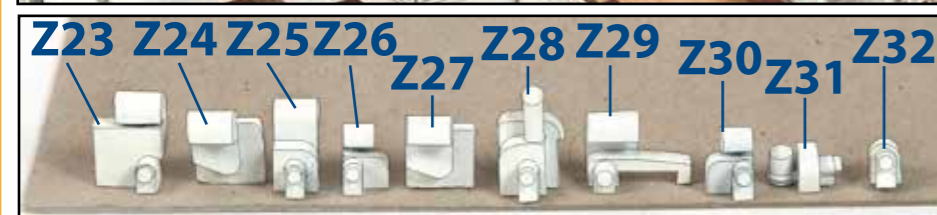
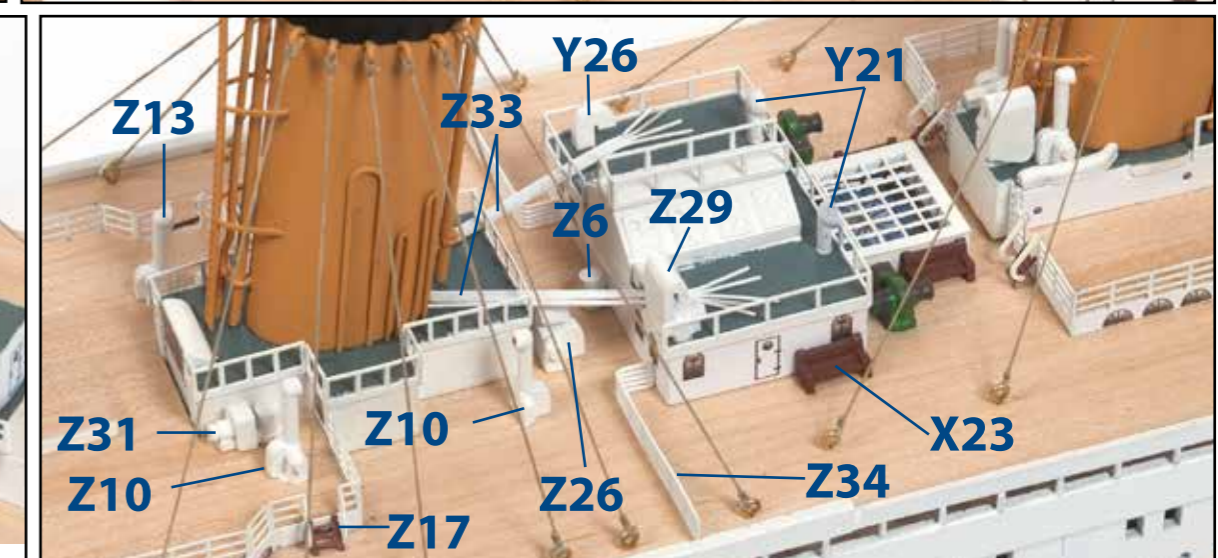
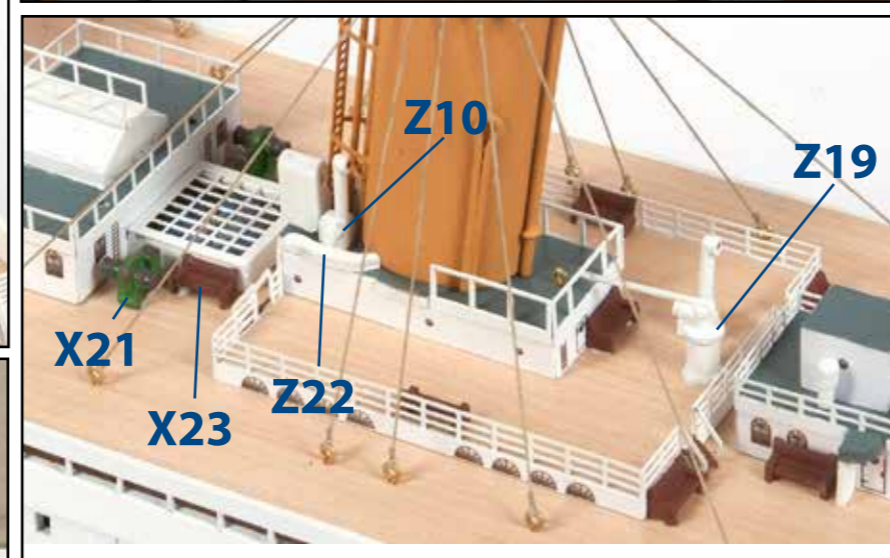
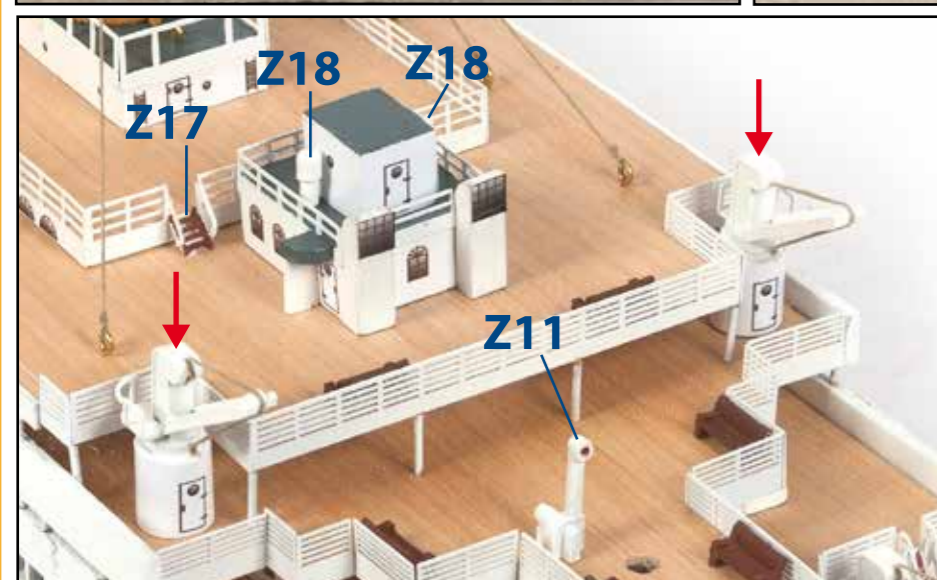
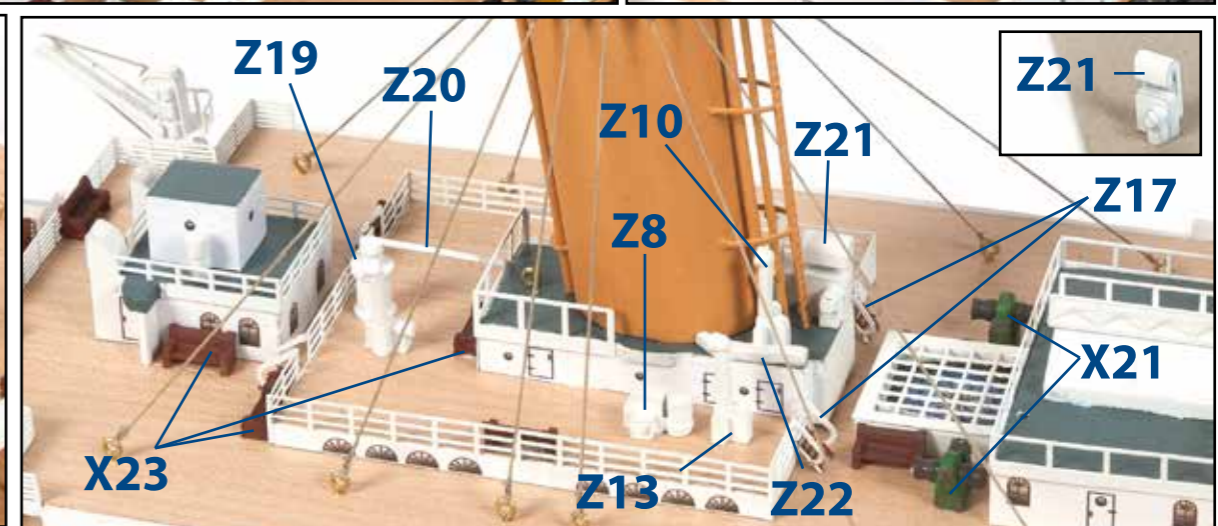
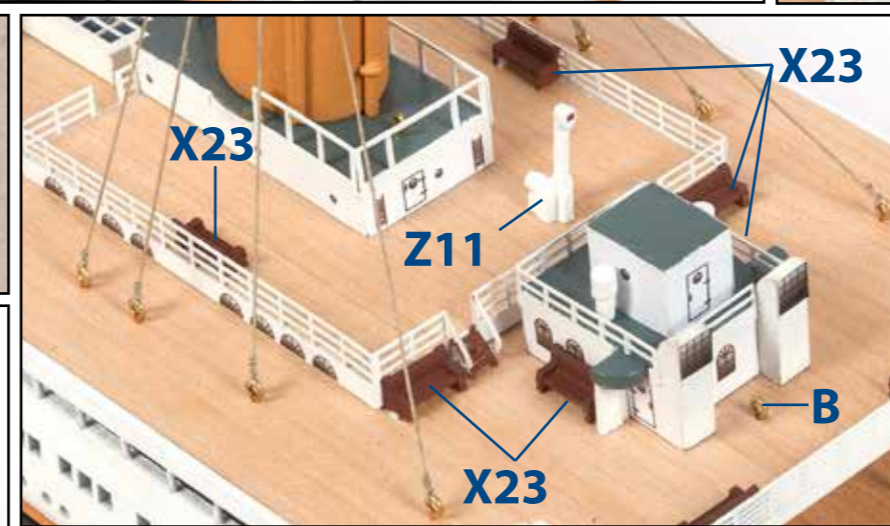
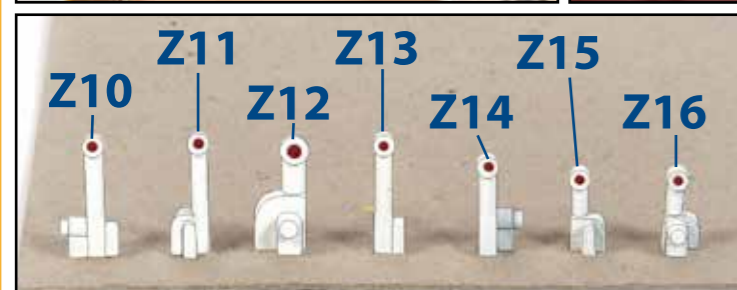
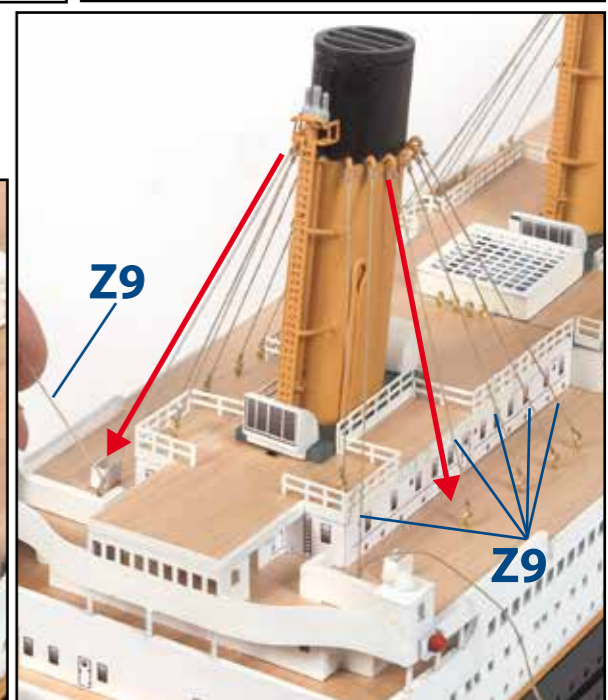
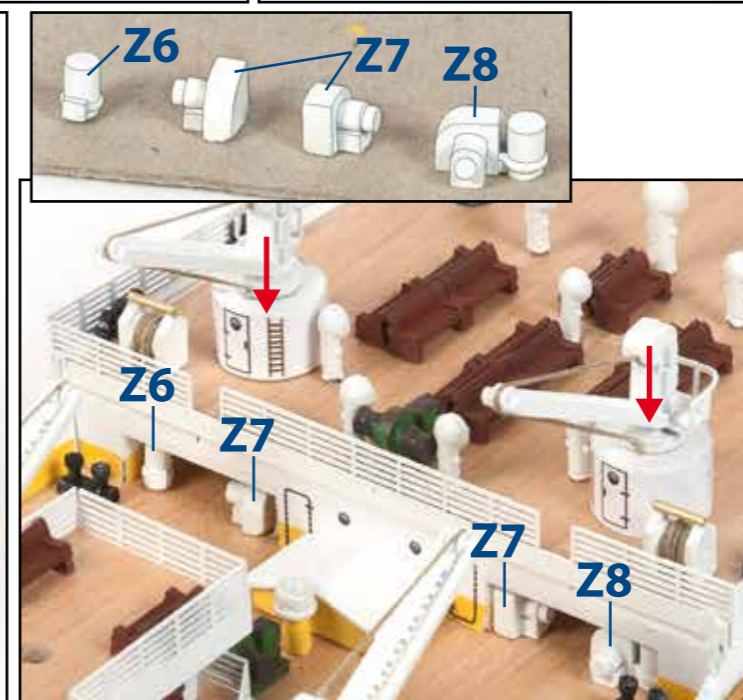
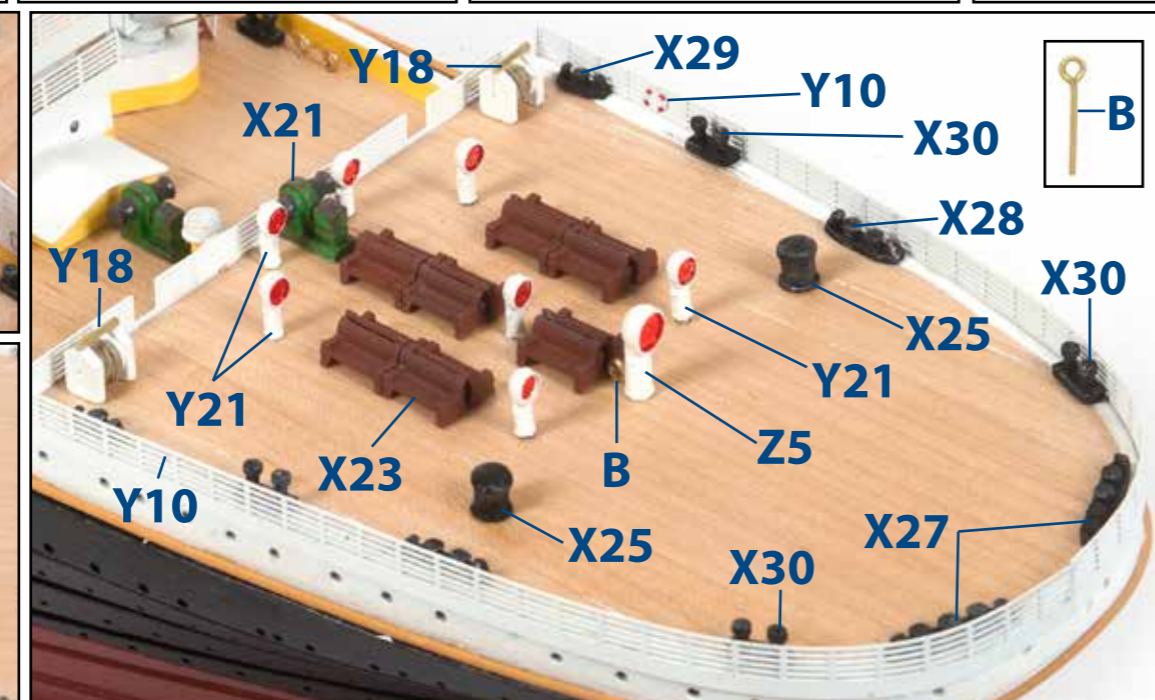
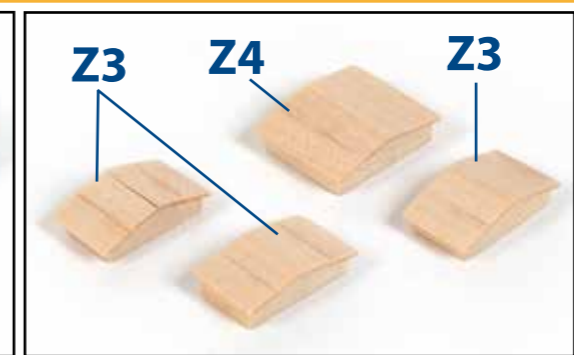
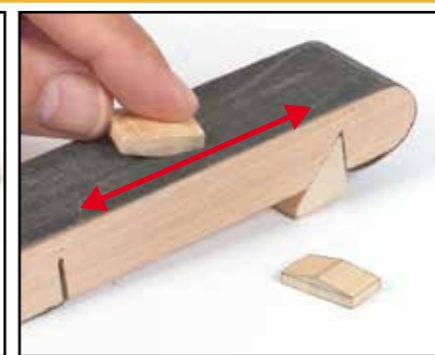
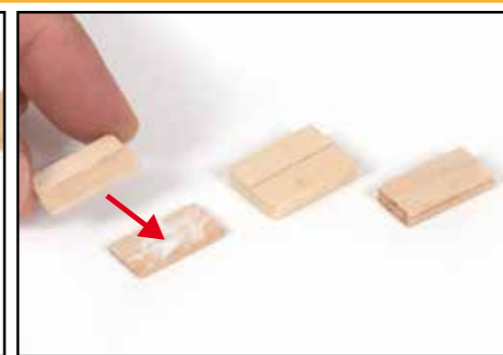
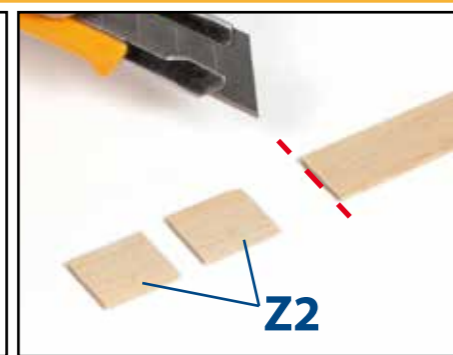
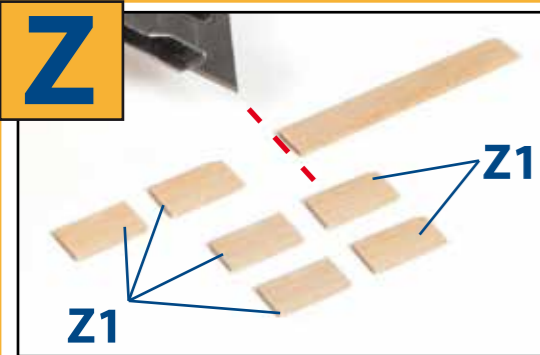

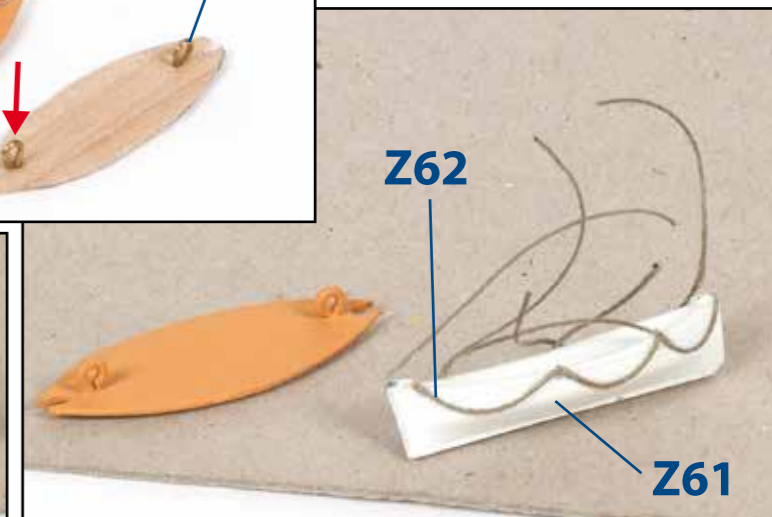
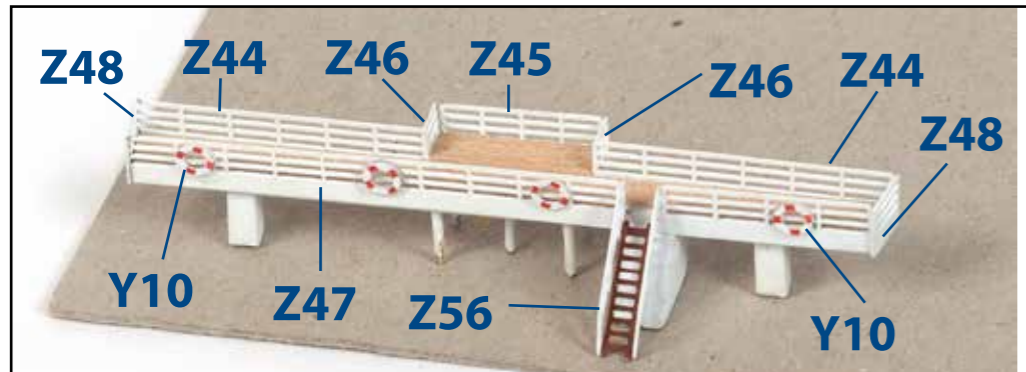
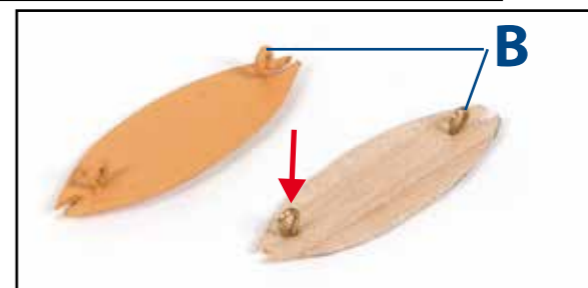
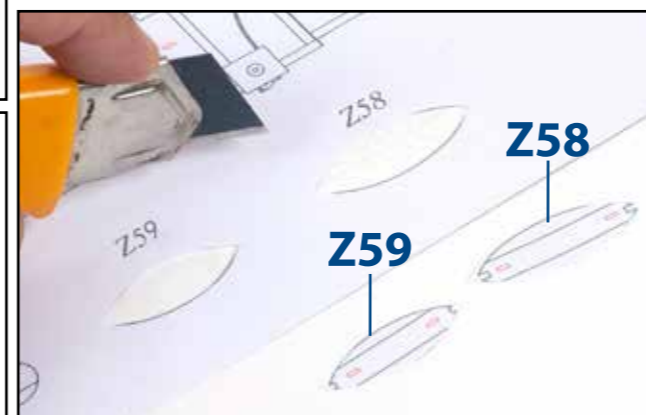
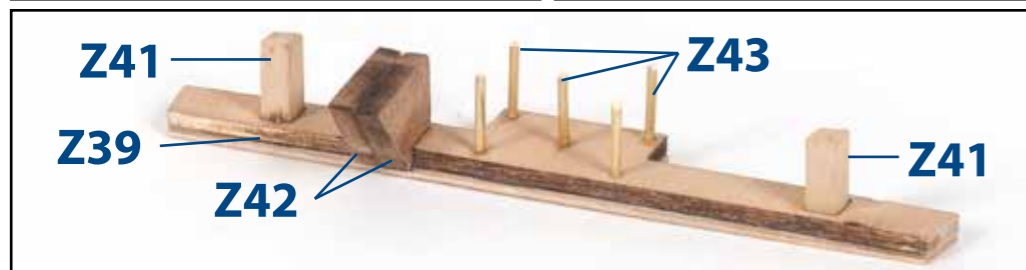
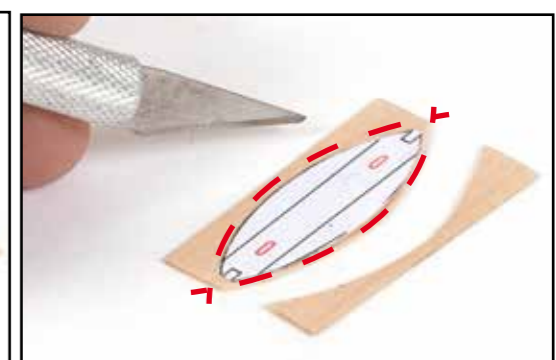
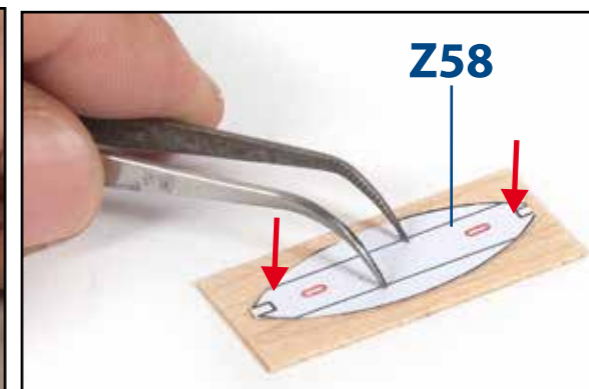
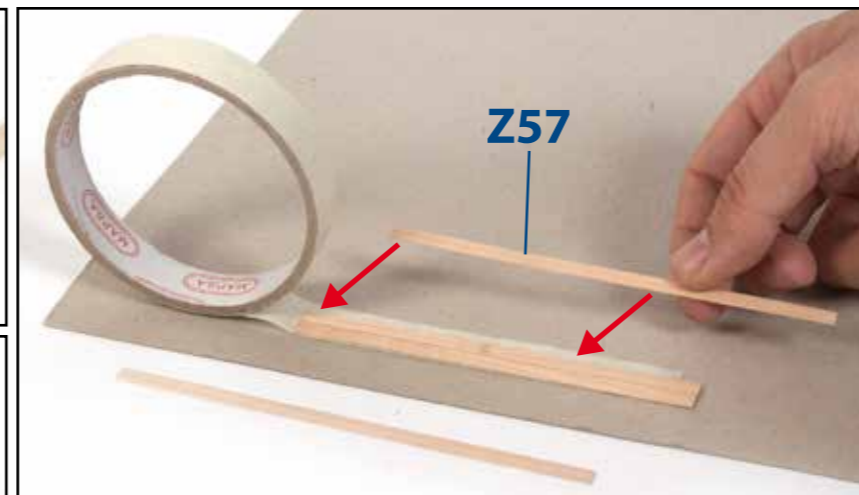
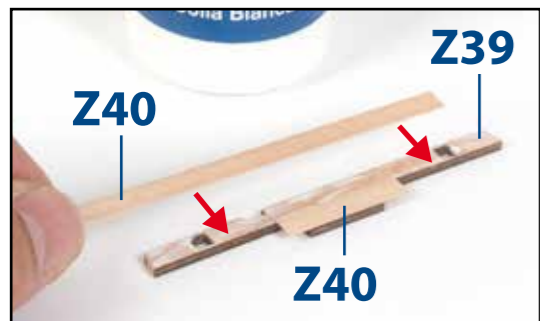
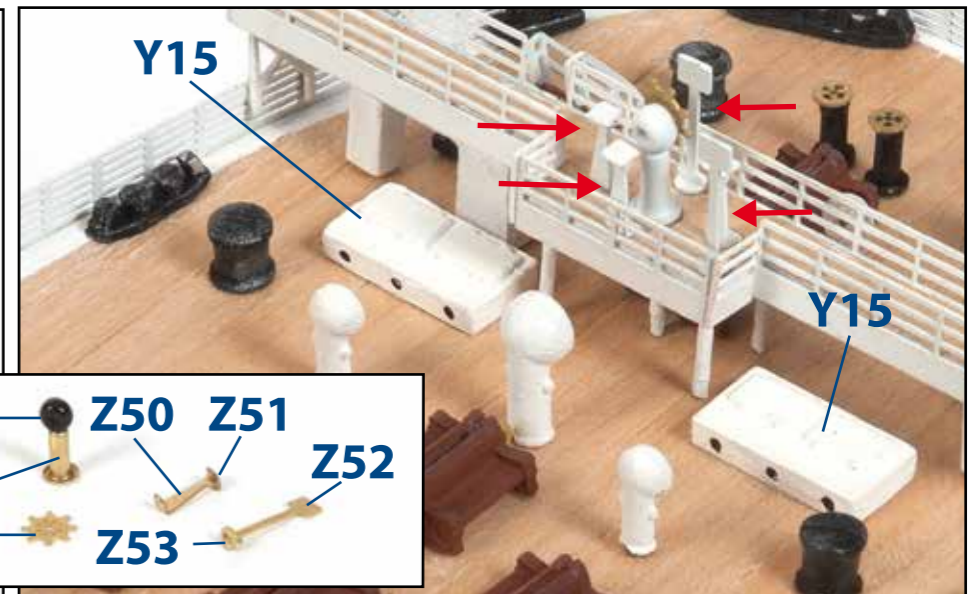
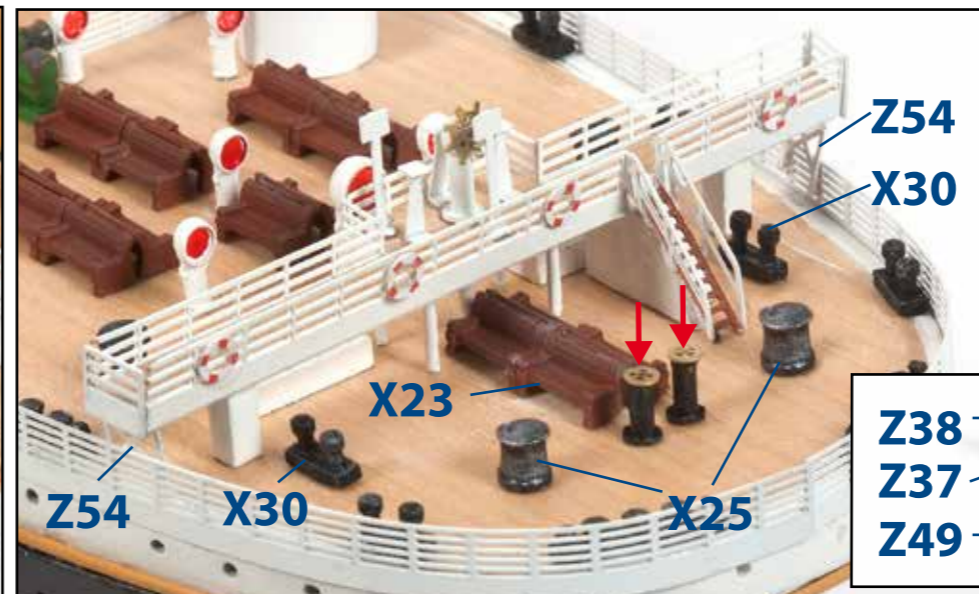
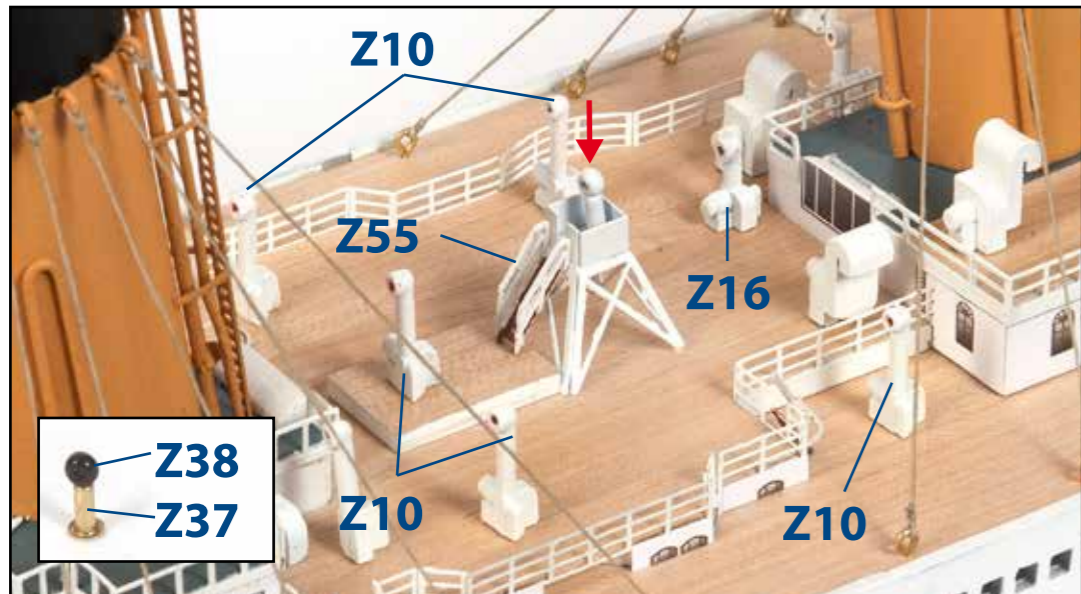
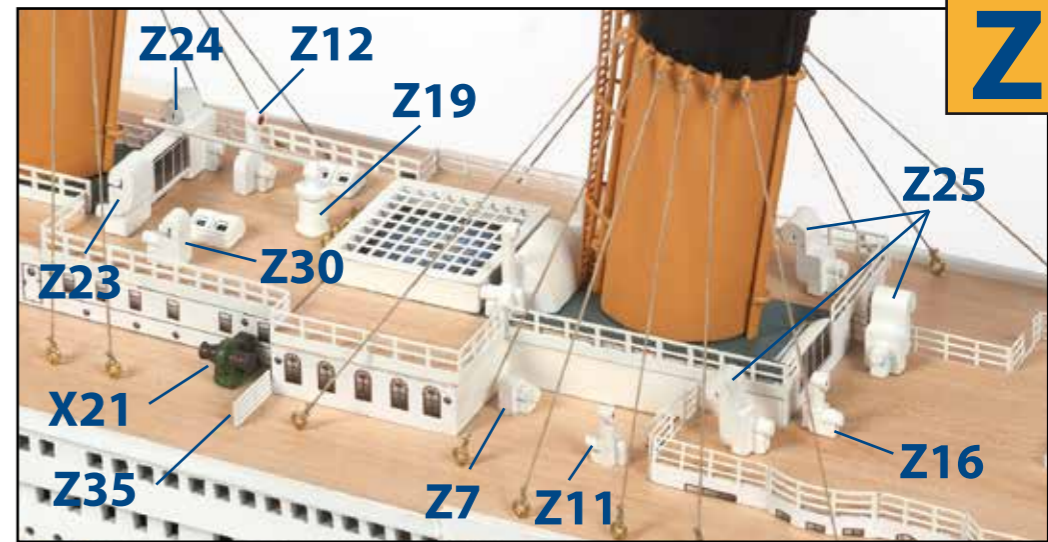
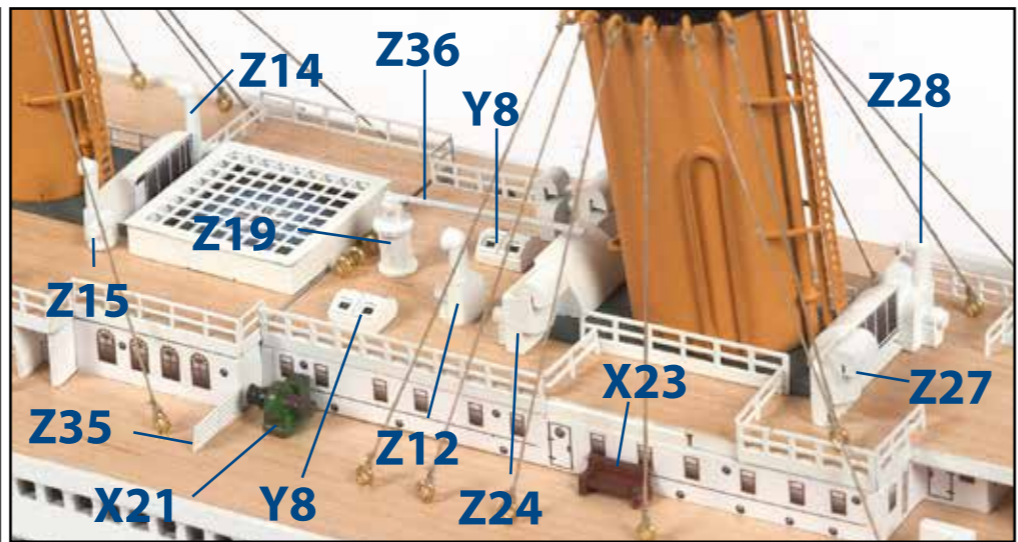
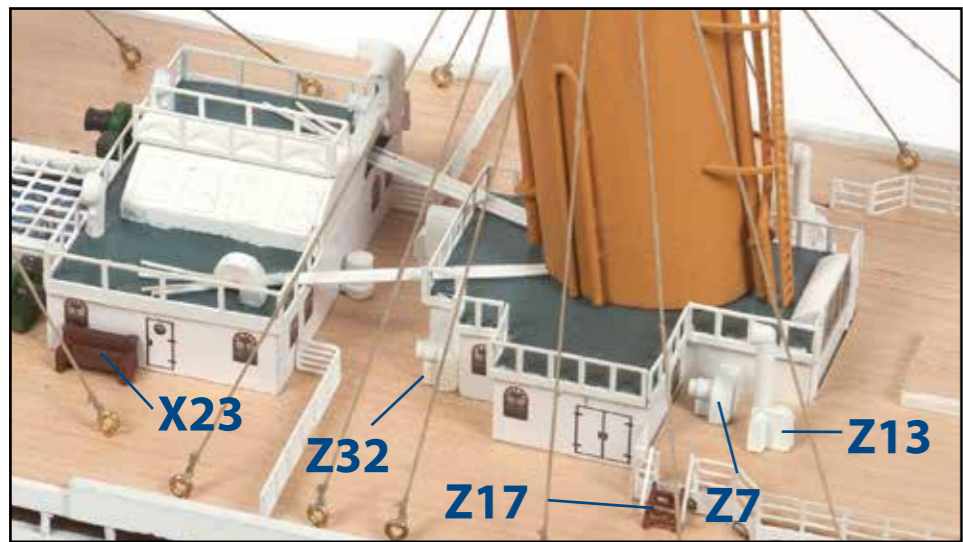

Z

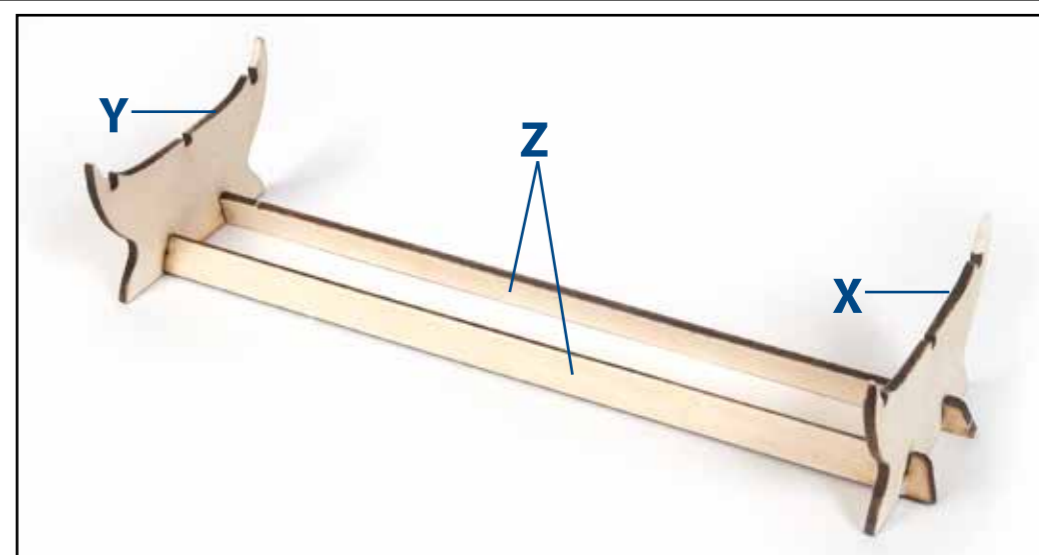
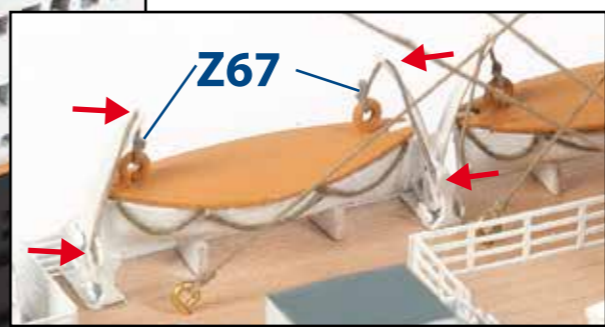
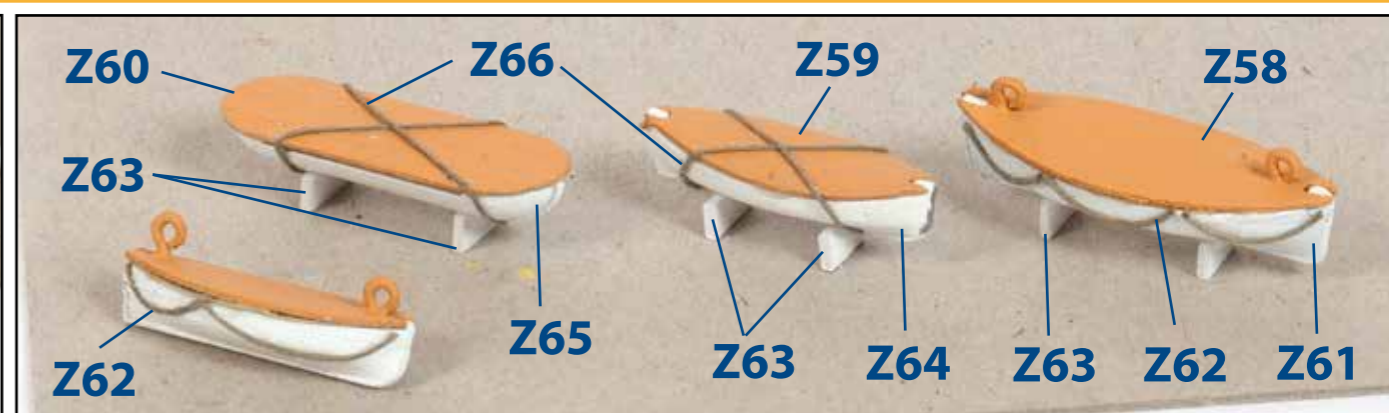



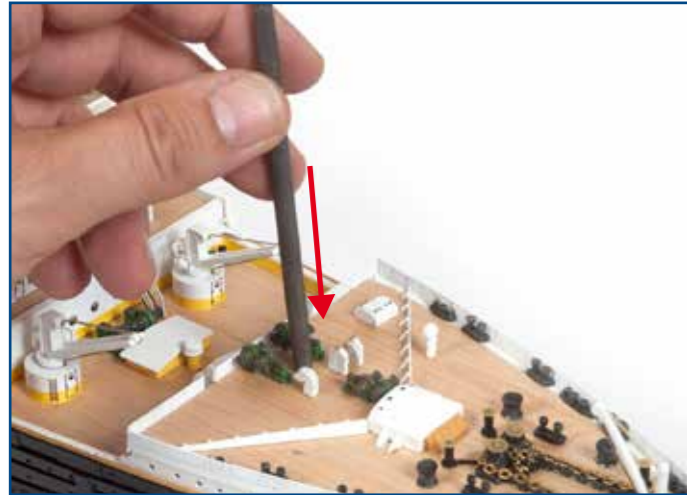
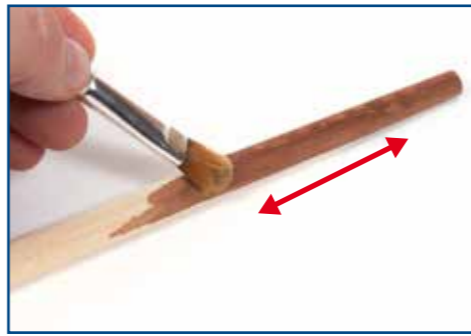
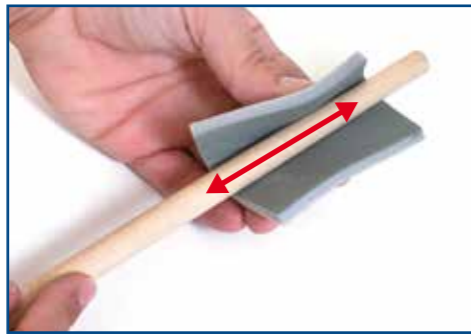
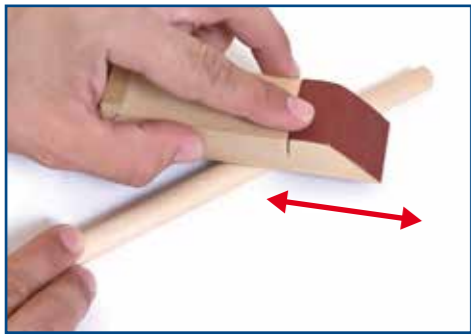

Consultar los planos de mástiles  
 Consult the masts drawings  
 Consulte os desenhos dos mastros  
 Consulter les dessins des mâts  
 Konsultieren Sie die Mastenzeichnungen  
 Обратитесь к рисункам мачты  
 Consultare i disegni degli alberi

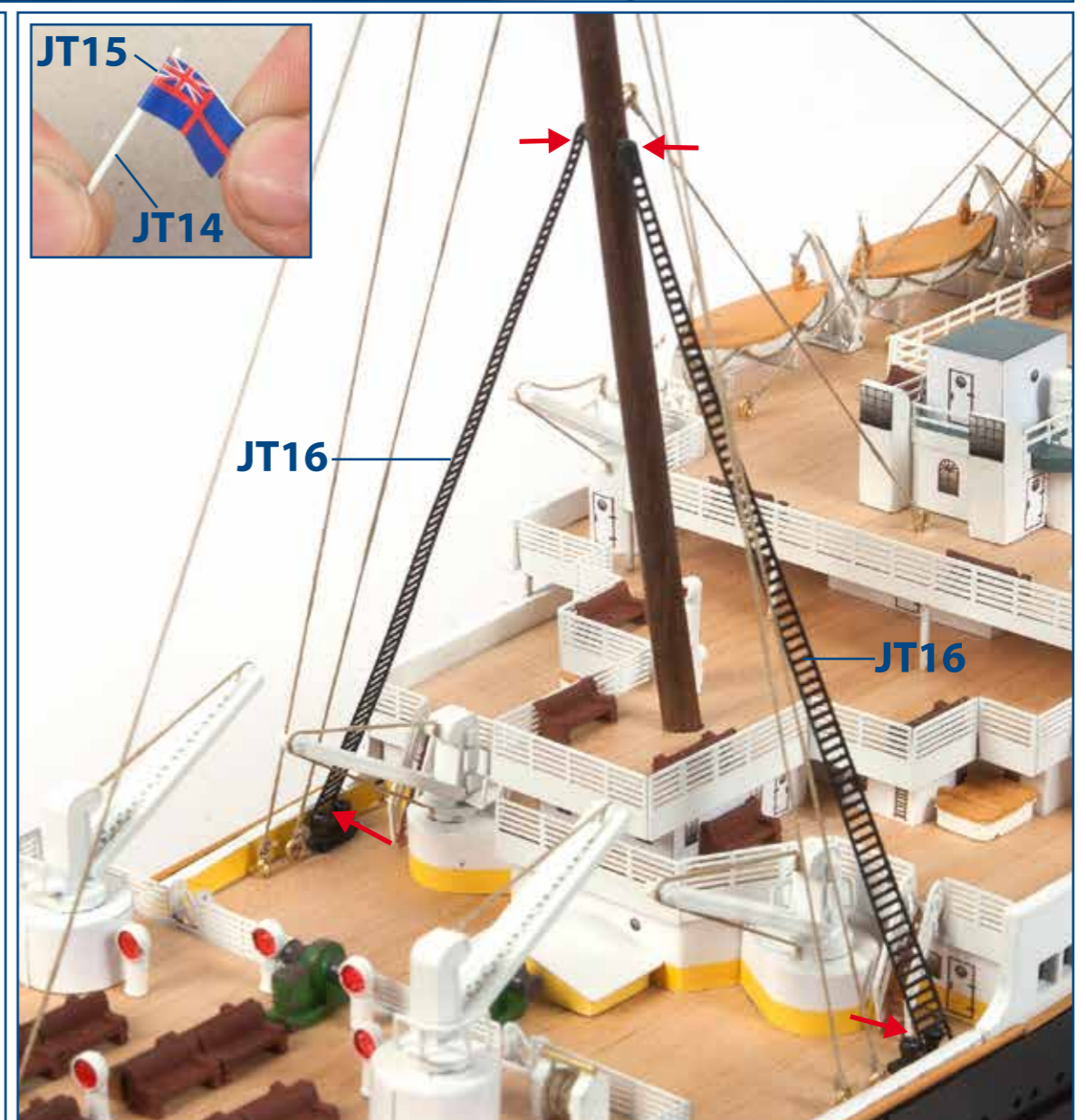
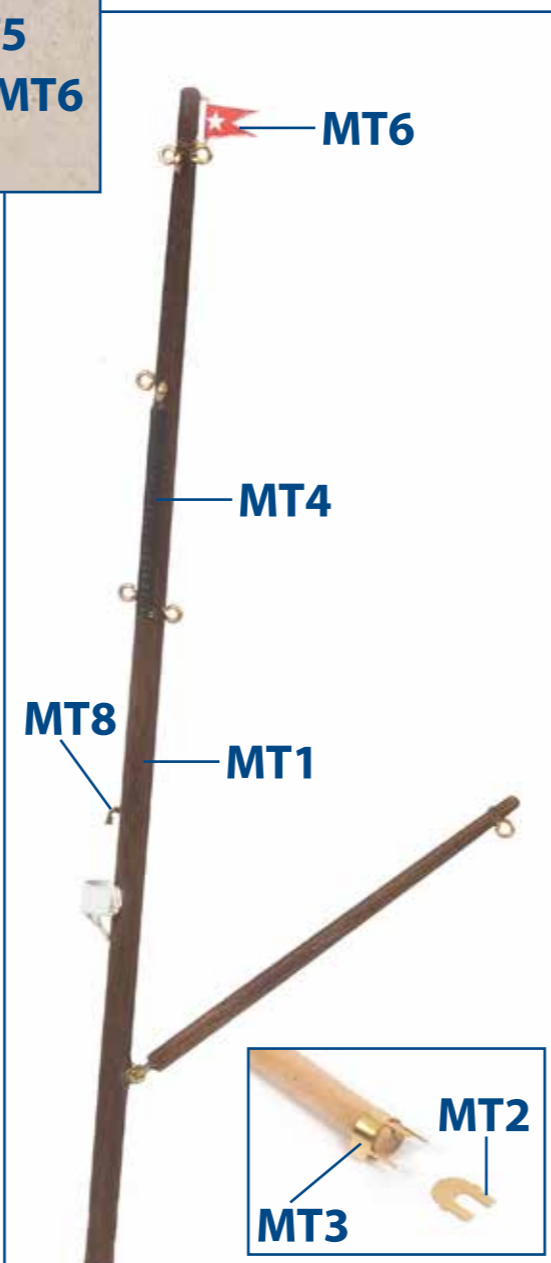

IP

*Titanic*

Ref.14009

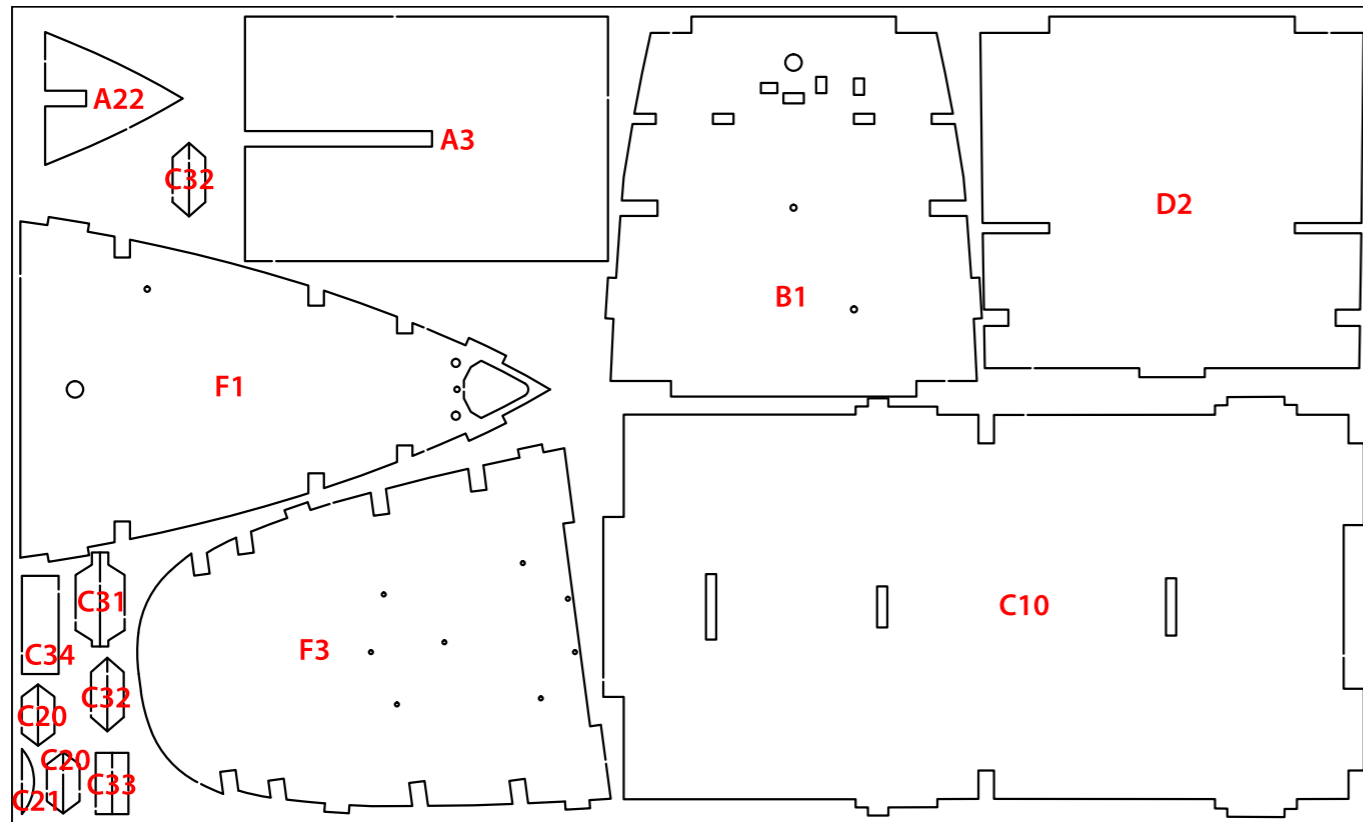

14009-4

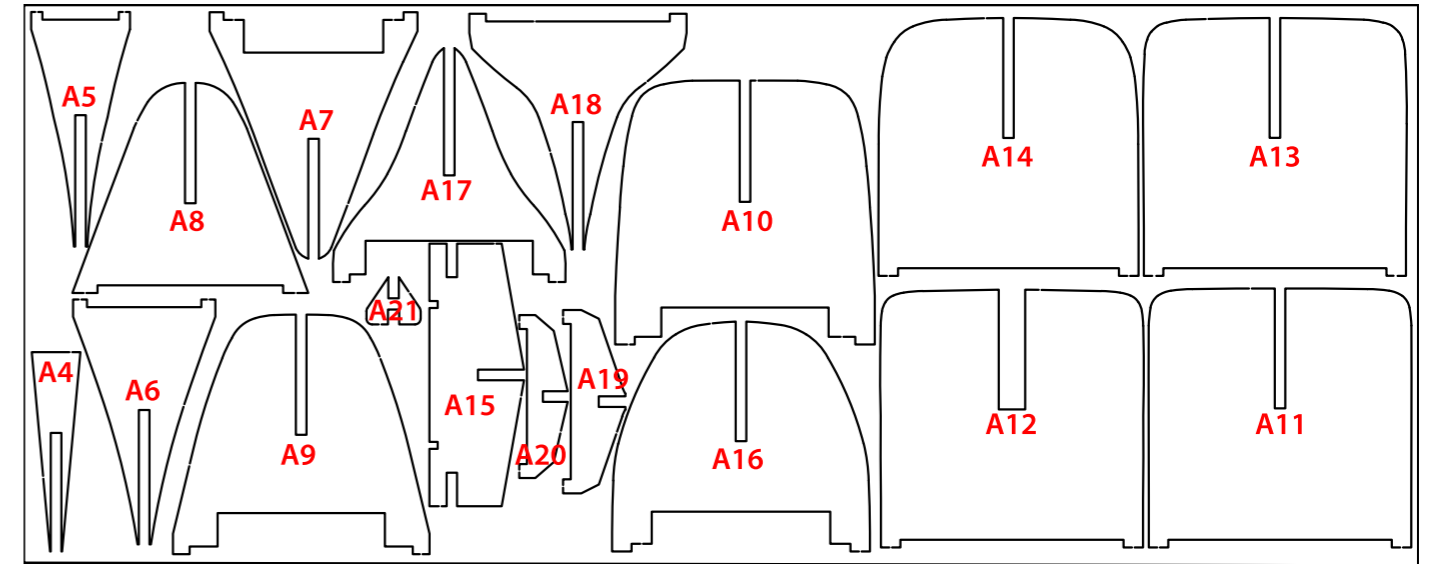

14009-2

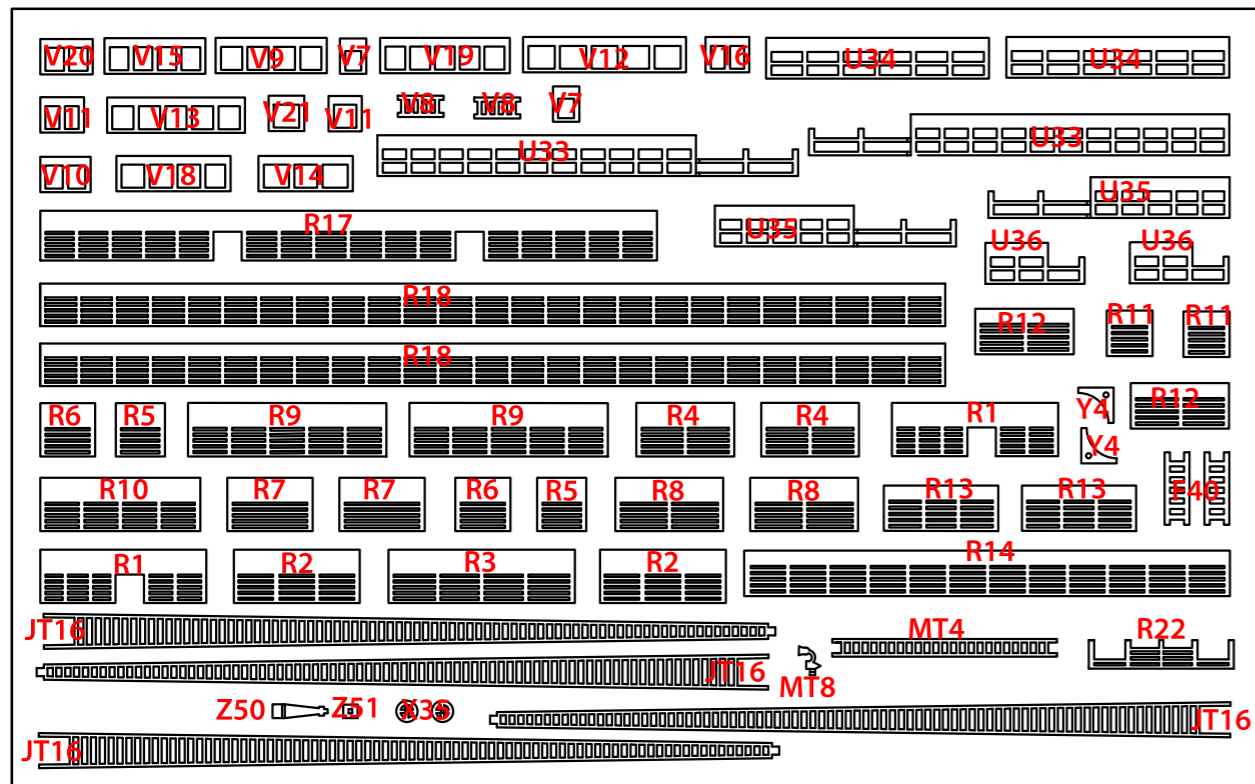

14009-14

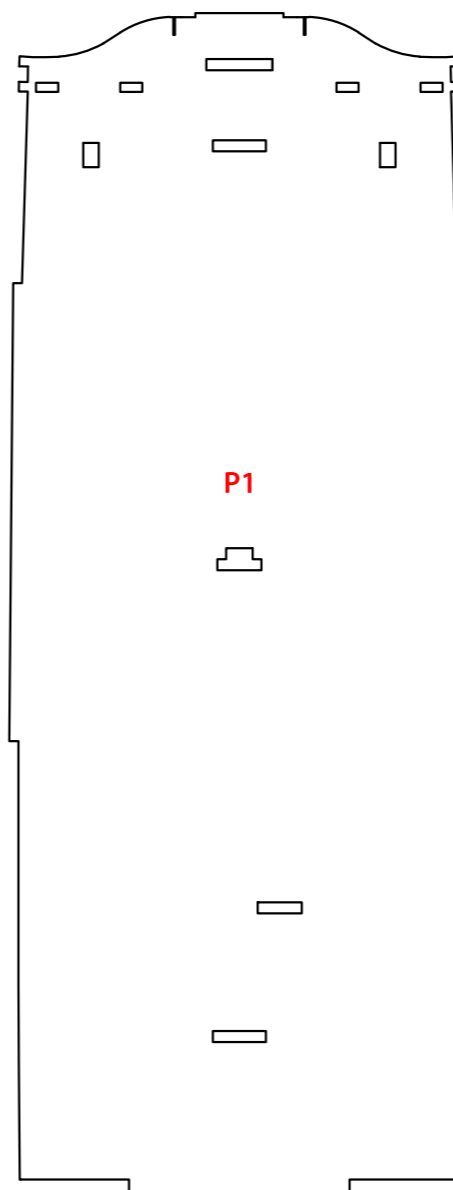

14009-7

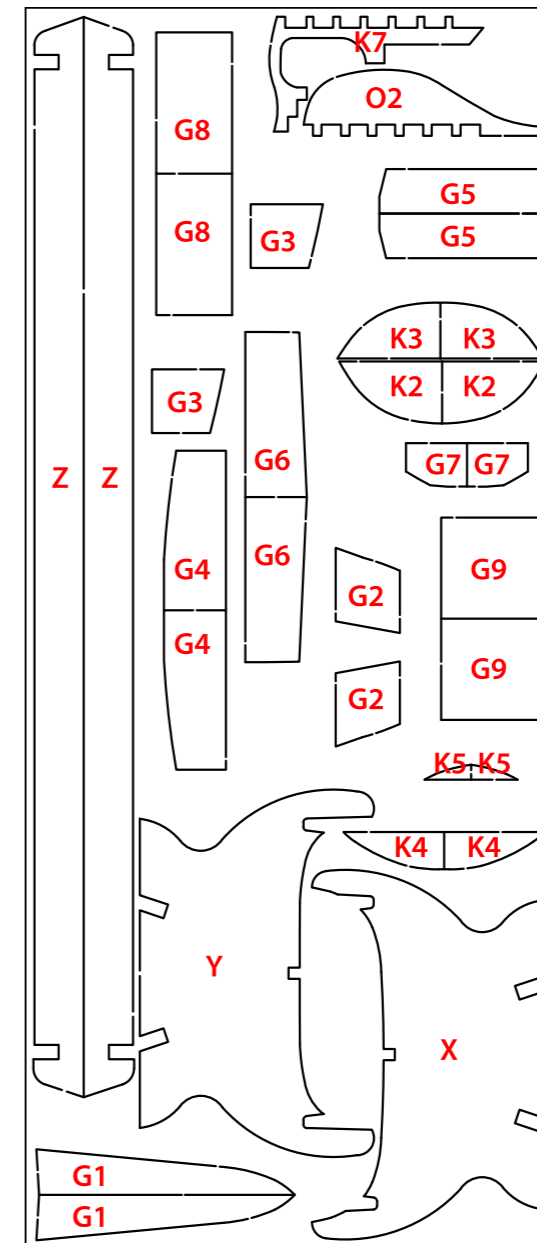

14009-3

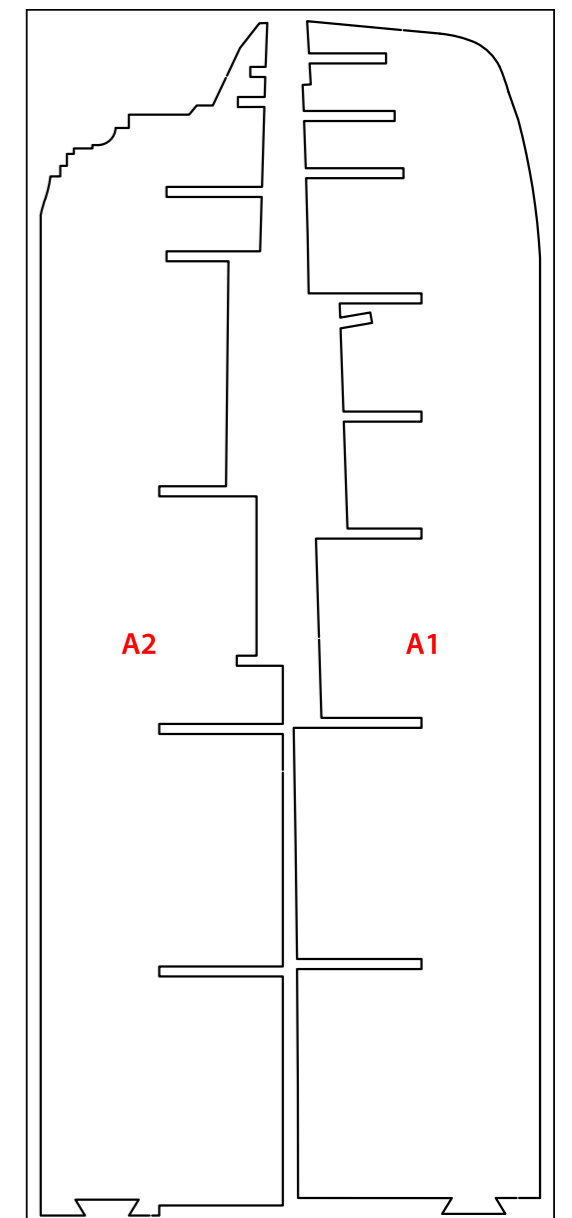

14009-1

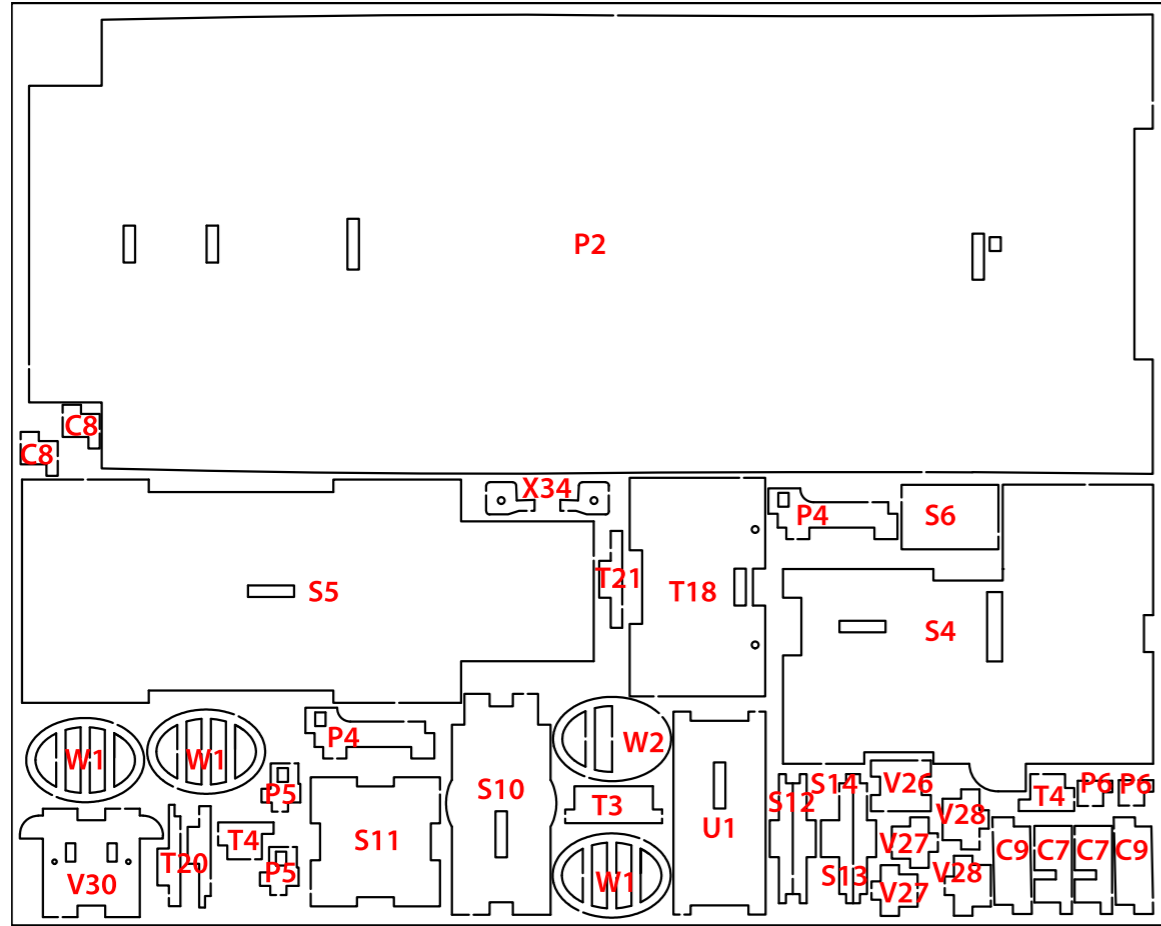

14009-6

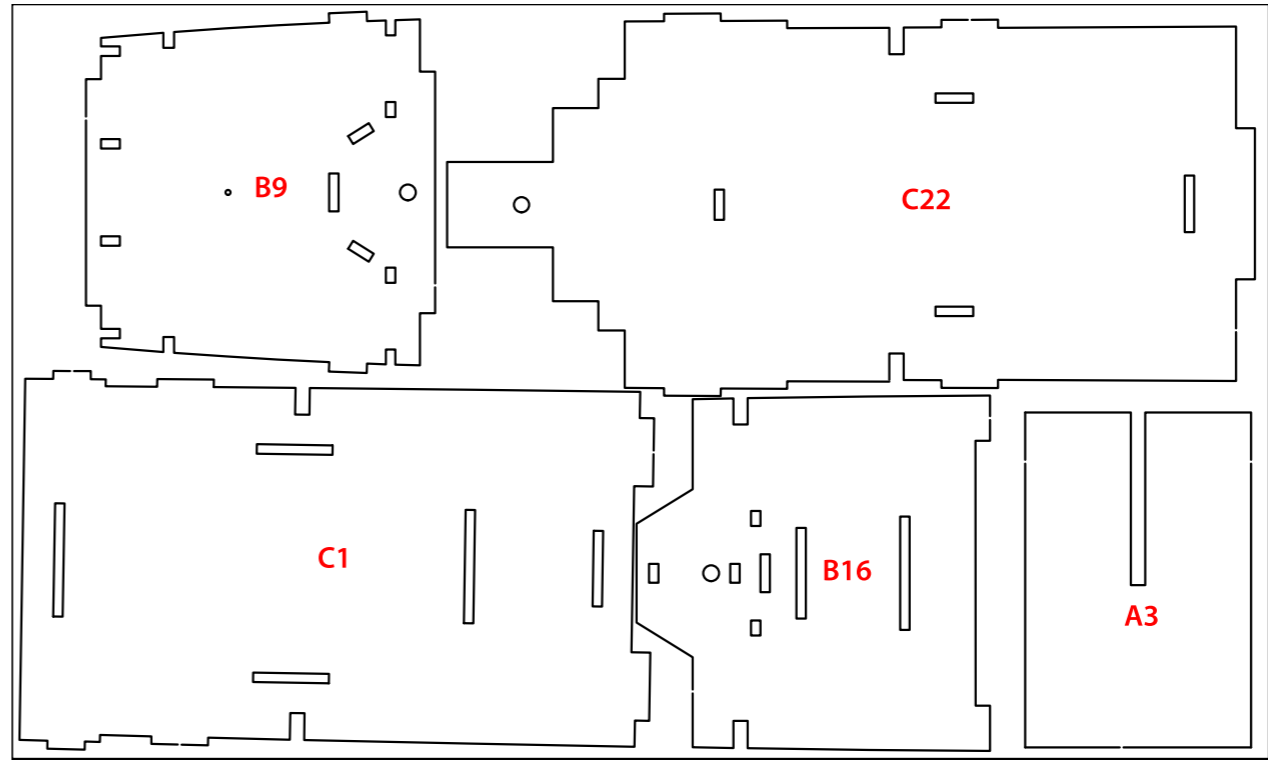

14009-5

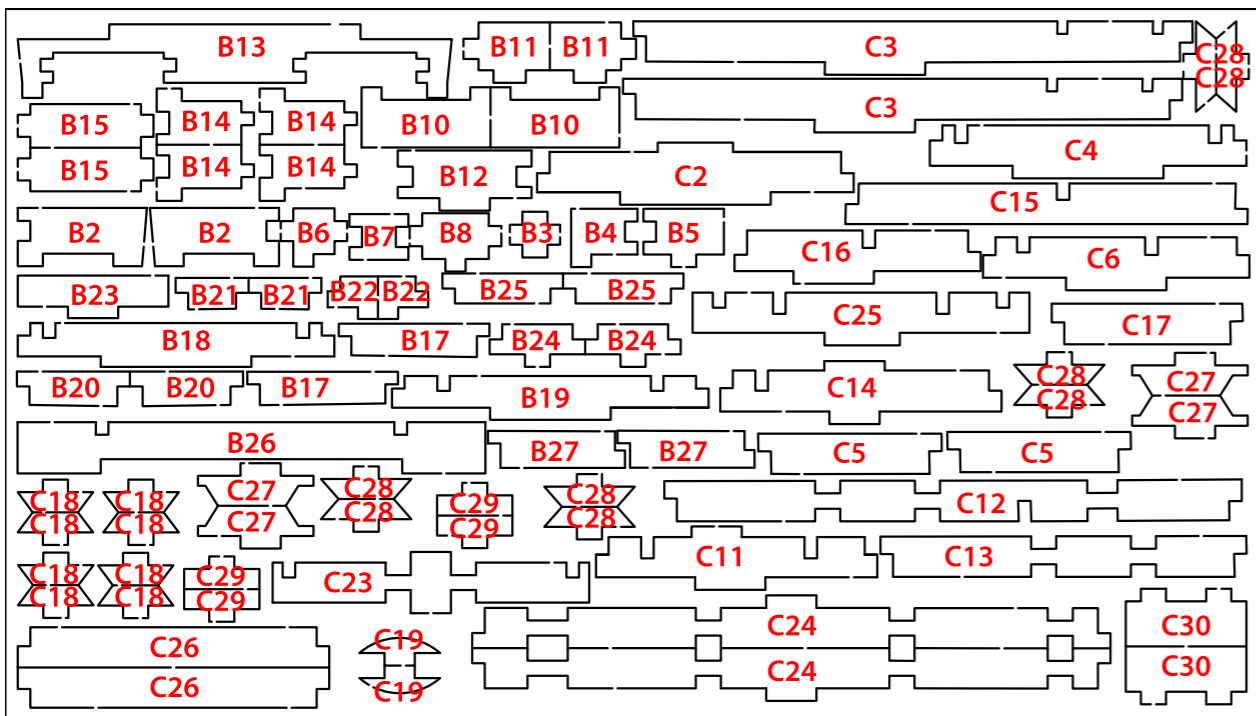

14009-9

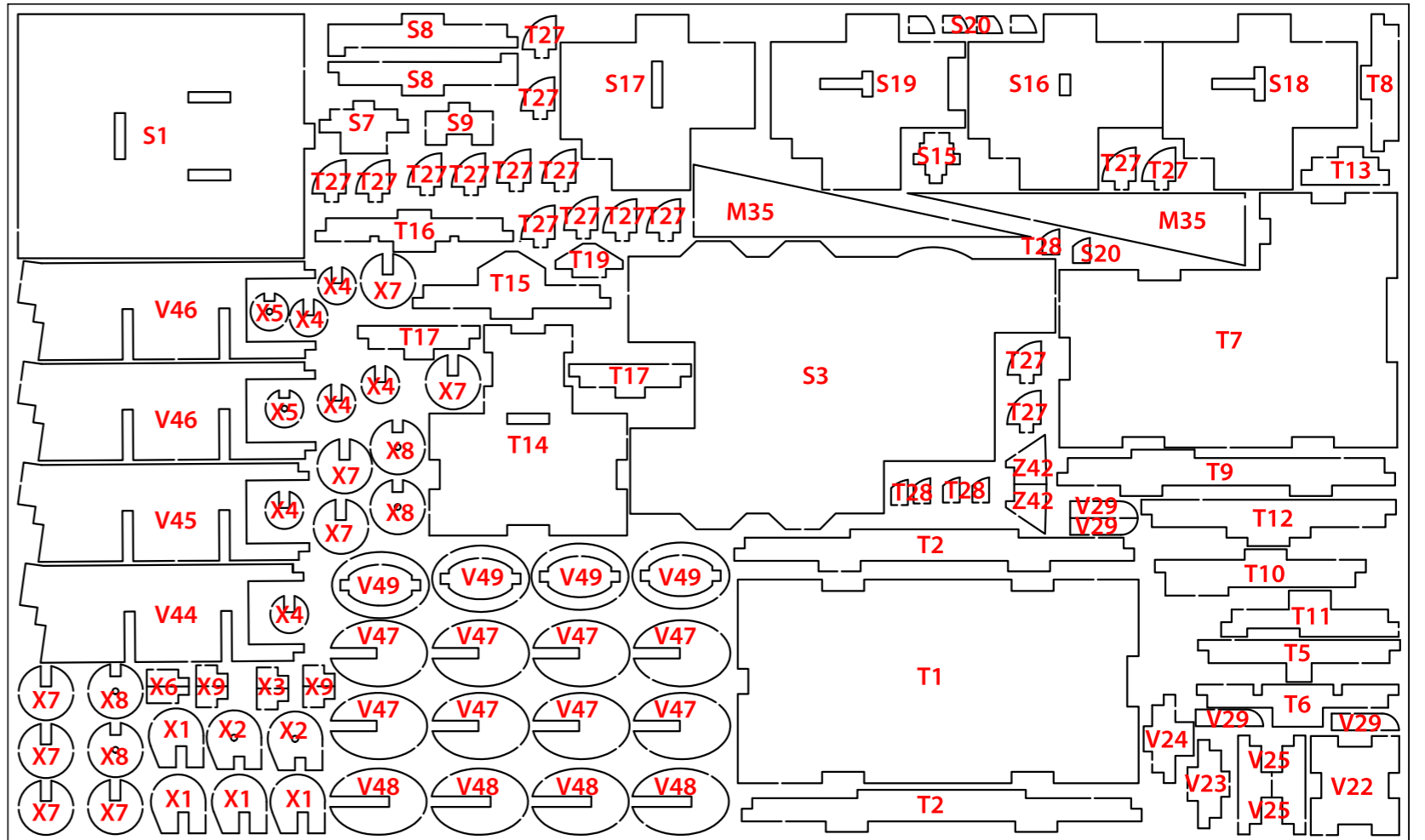

14009-10

IP

*Titanic*

Ref.14009

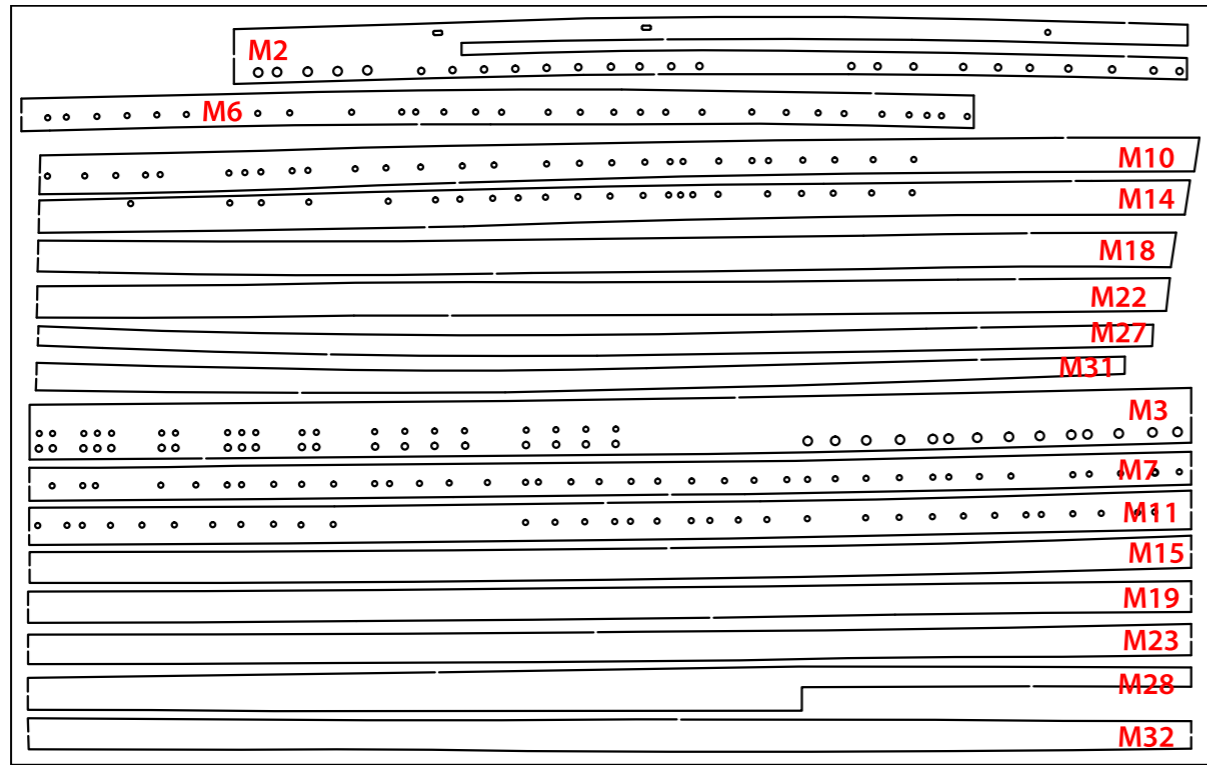

14009-11

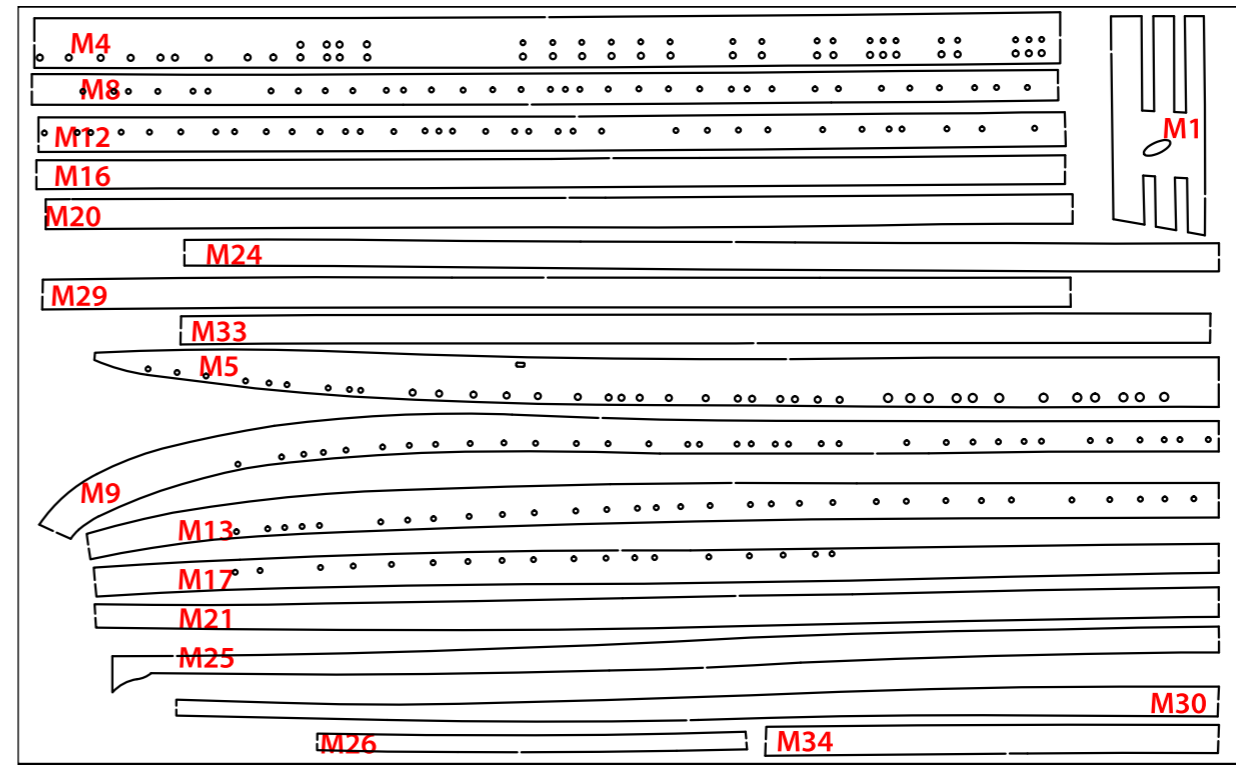

14009-12

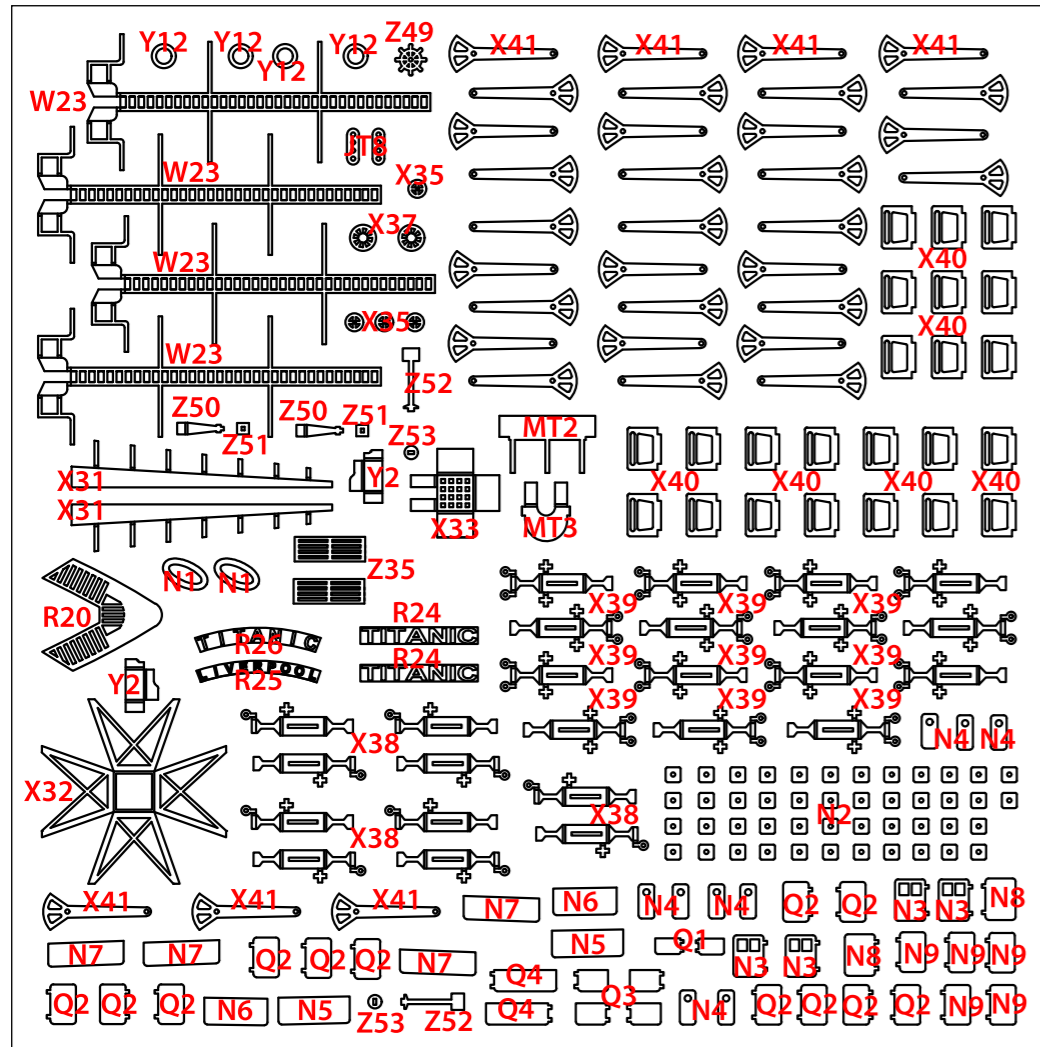

14009-15

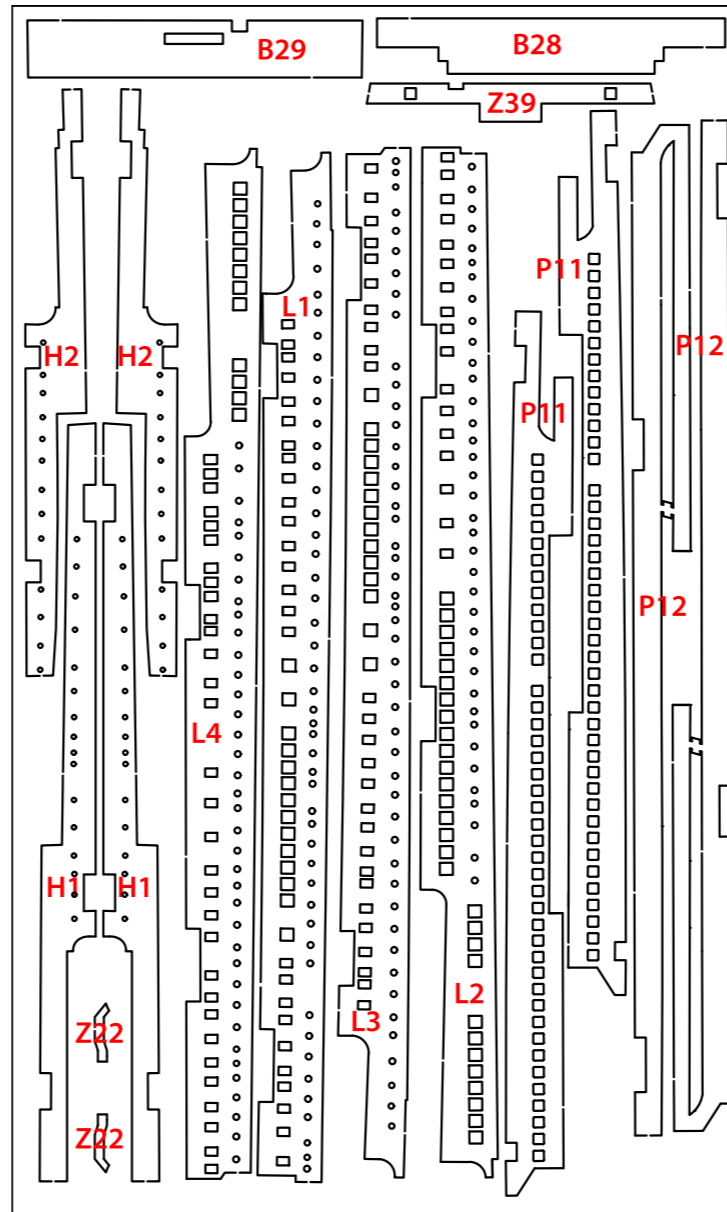

14009-8

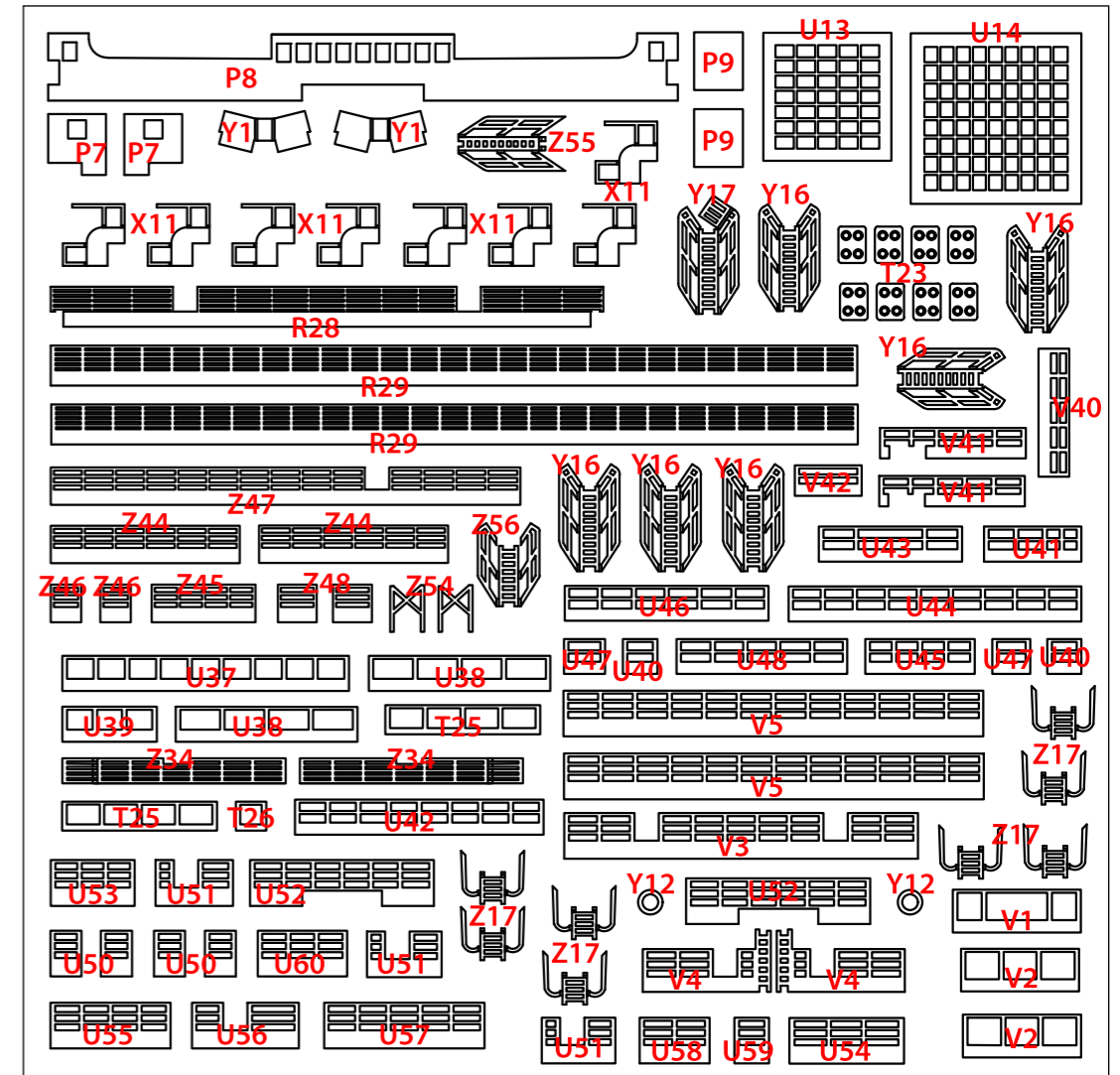

14009-13

# Titanic

Palo trinquete / Fore mast / Mât de misaine  
Albero trinchetto / Fockmast

Palo mayor / Main mast / Grand mât  
Hauptmast / Albero maestro

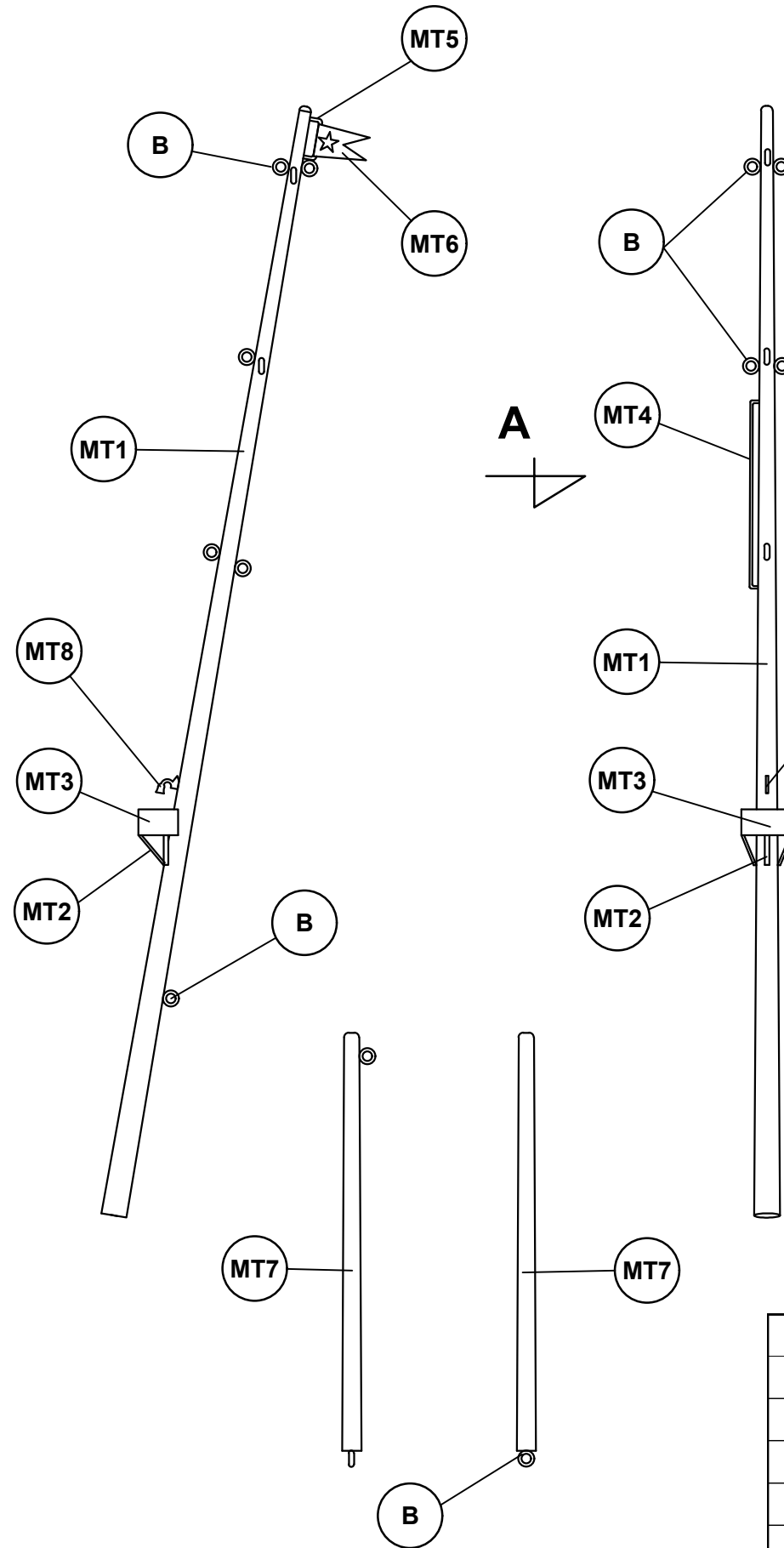
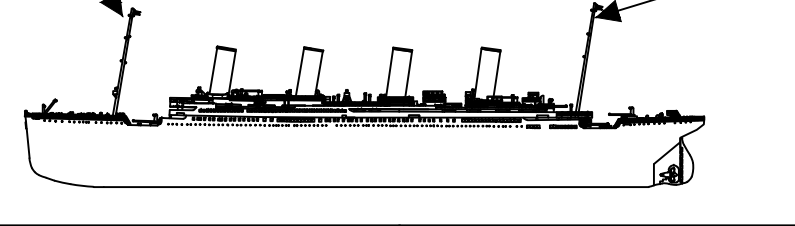

Palo trinquete / Fore mast / Mât de misaine  
Albero trinchetto / Fockmast

MT1	∅4x175	Tilo / Lime wood / Tilleul / Linde / Tiglio
MT2	Preformado / Preformed / Préformé / Vorgeformt / Preformato	Latón / Brass / Laiton / Messing / Ottone
MT3	Preformado / Preformed / Préformé / Vorgeformt / Preformato	Latón / Brass / Laiton / Messing / Ottone
MT4	Preformado / Preformed / Préformé / Vorgeformt / Preformato	Latón / Brass / Laiton / Messing / Ottone
MT5	∅0,5x12	Latón / Brass / Laiton / Messing / Ottone
MT6	Preformado / Preformed / Préformé / Vorgeformt / Preformato	Vinilo / Vinyl / Vinyle / Vinyl / Vinile
MT7	∅3x65	Tilo / Lime wood / Tilleul / Linde / Tiglio
MT8	Preformado / Preformed / Préformé / Vorgeformt / Preformato	Latón / Brass / Laiton / Messing / Ottone
MT9	∅4x172	Tilo / Lime wood / Tilleul / Linde / Tiglio
B	15	Latón / Brass / Laiton / Messing / Ottone

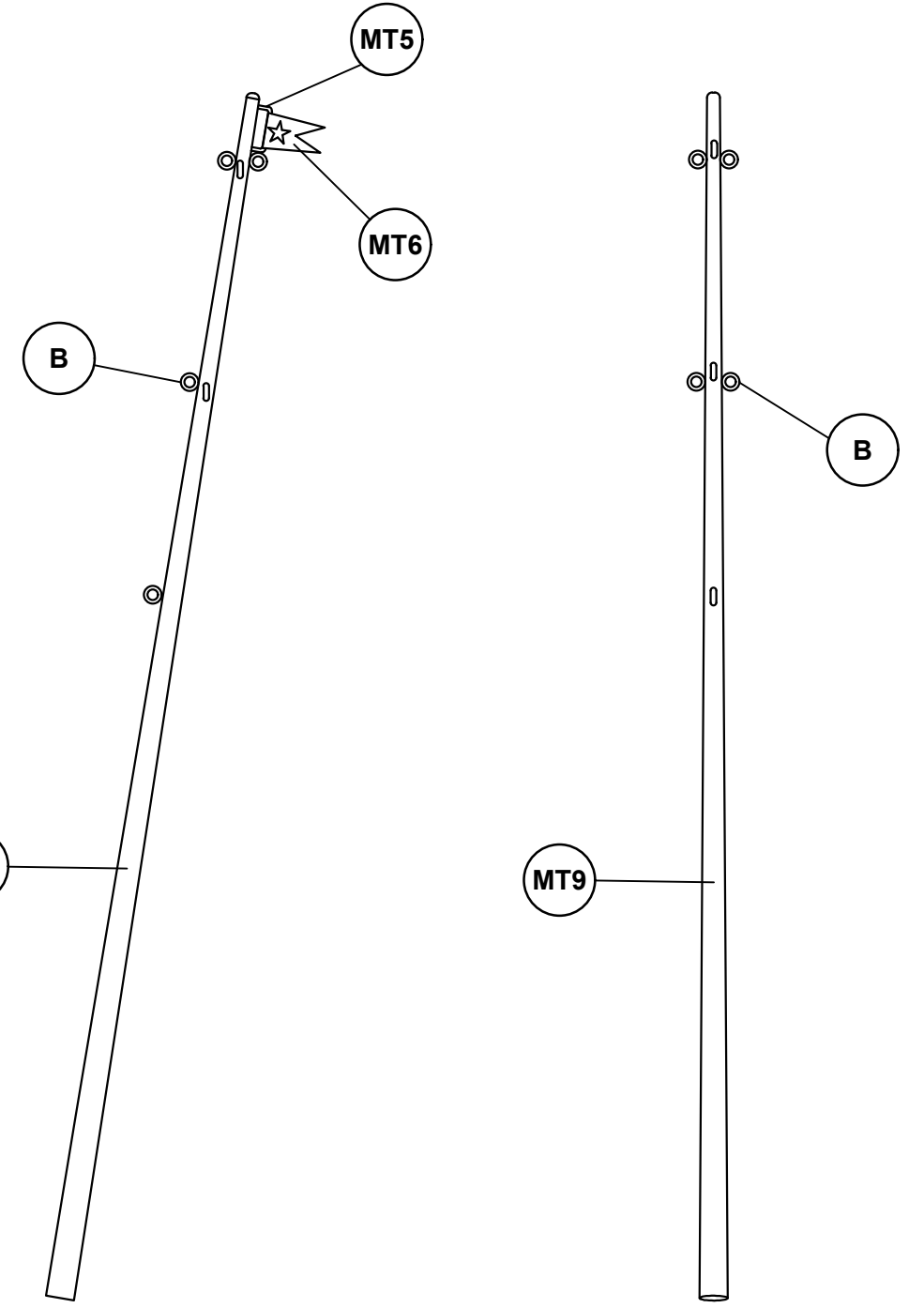

Palo mayor / Main mast / Grand mât  
Hauptmast / Albero maestro

<b>B</b> —○	<b>H</b> ○
<i>Cáncamo</i>	<i>Anilla</i>
<i>Eyebolts</i>	<i>Rings</i>
<i>Piton à oeil</i>	<i>Oeil</i>
<i>Tragöse</i>	<i>Öse</i>
<i>Cavilie di ferro ad anello</i>	<i>Anello</i>

# Titanic

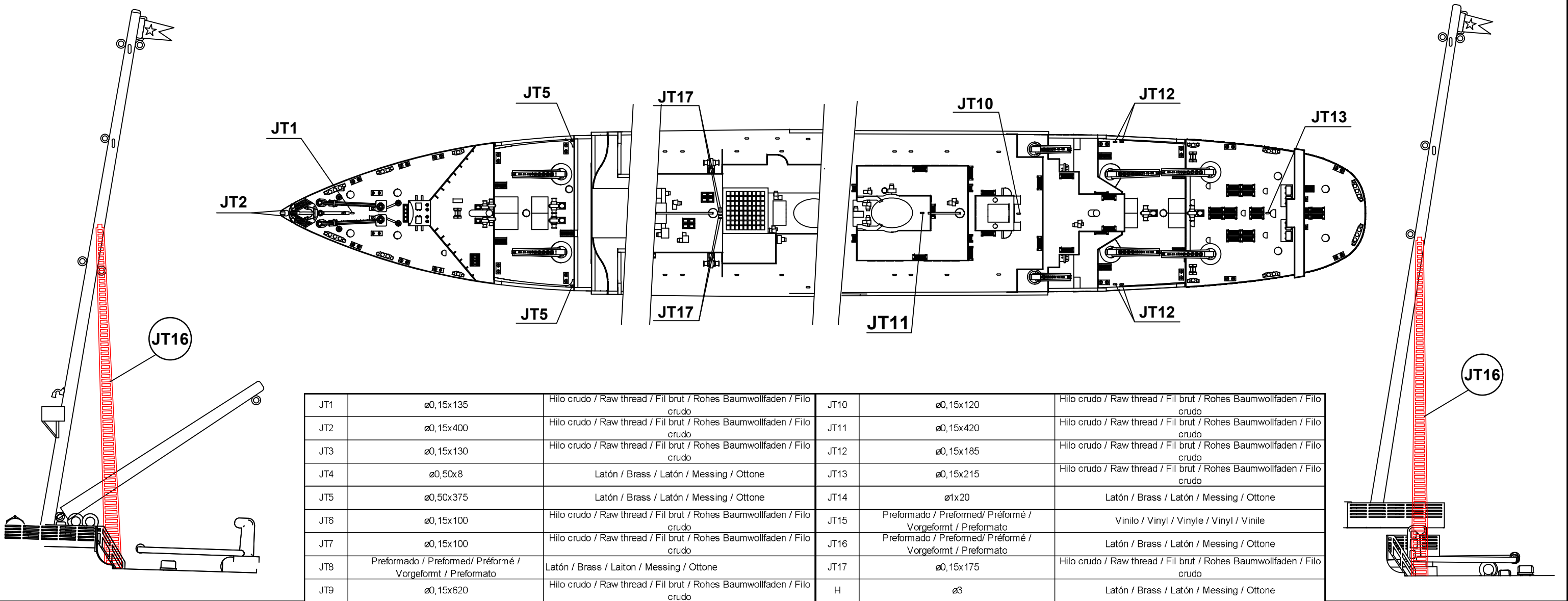
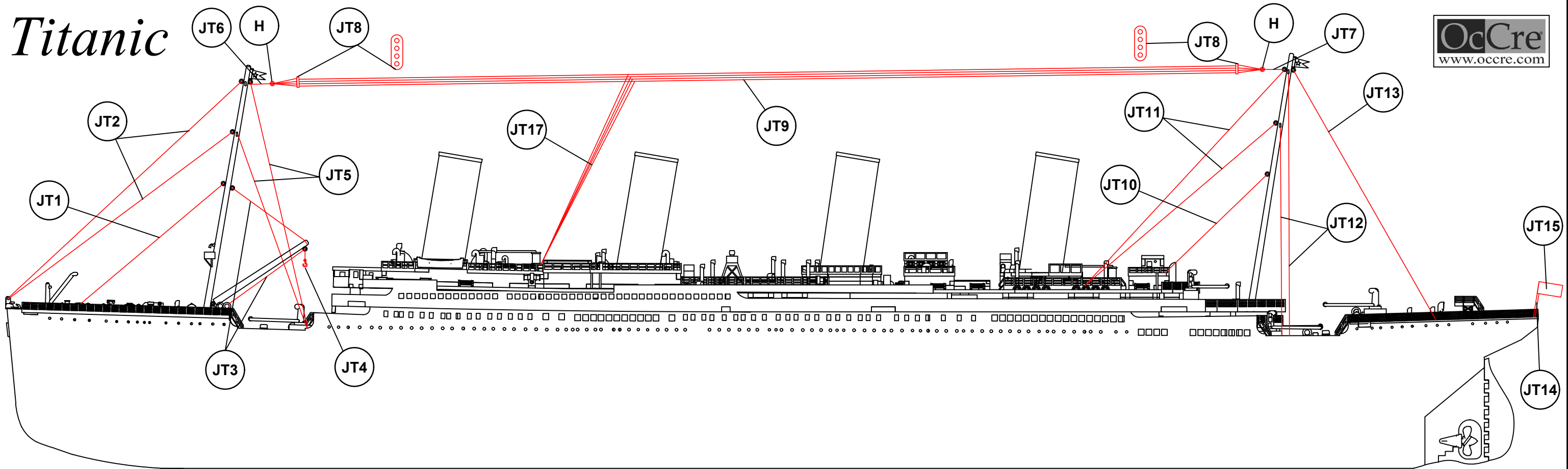

# Titanic

## PL-01

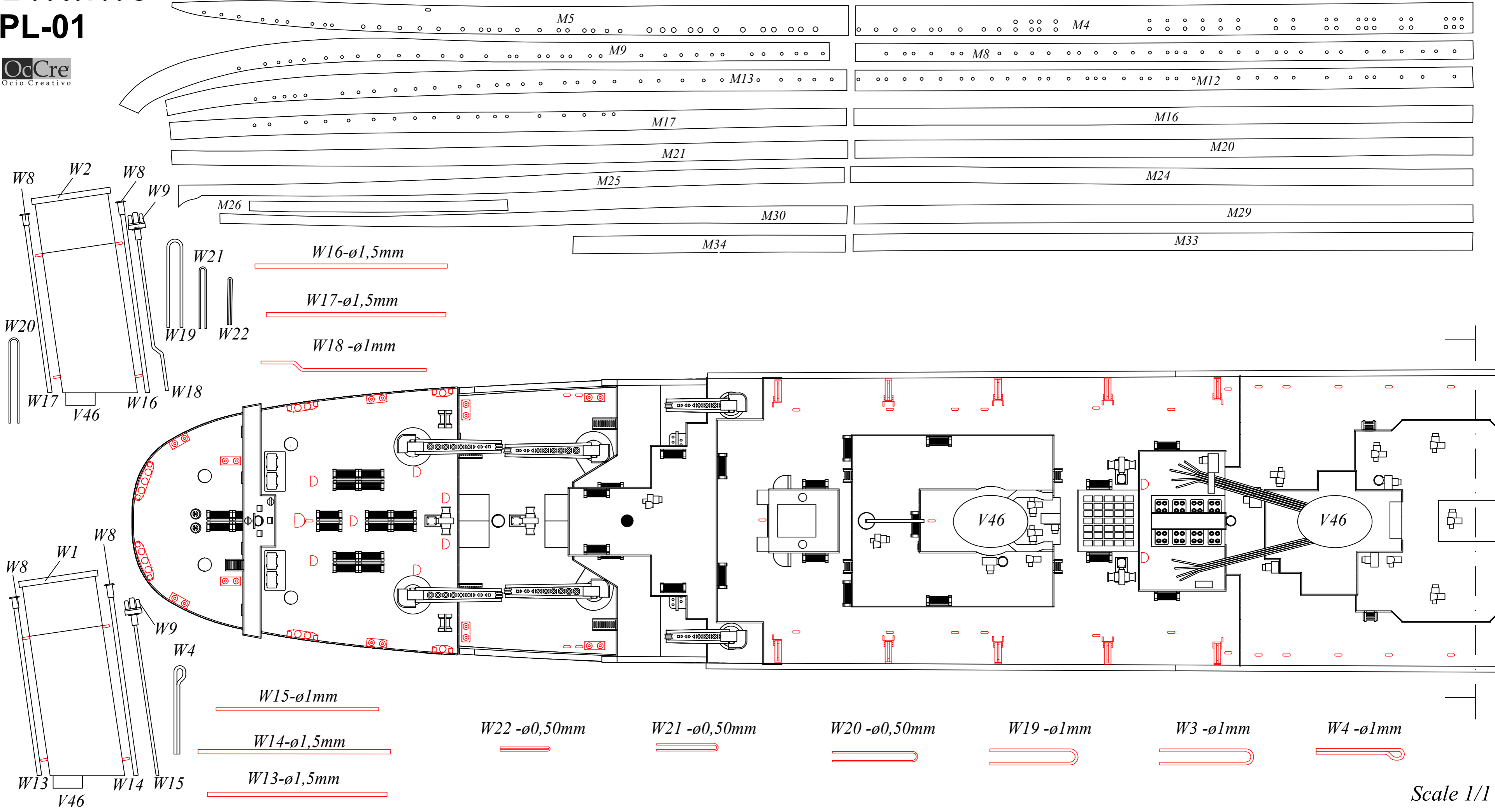

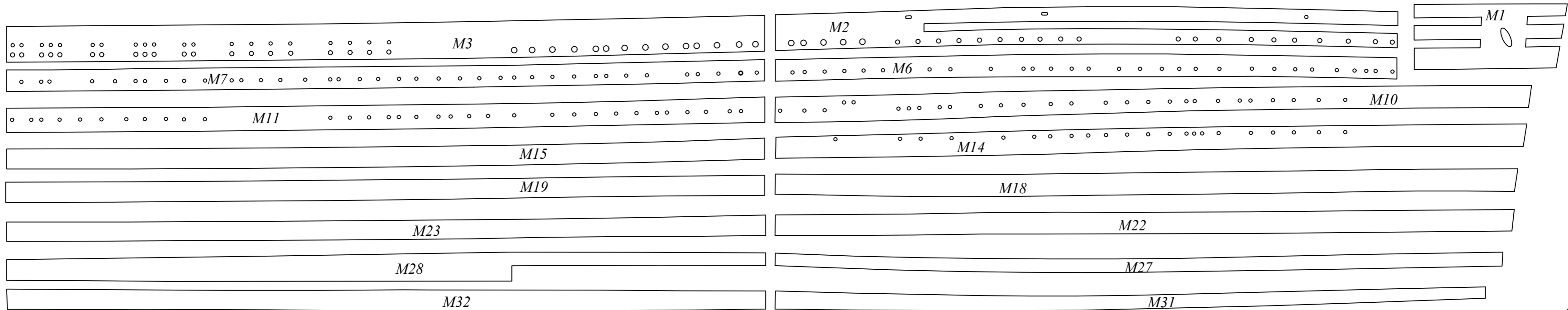

Z33 - $\phi$ 0.5mm

Z33 - $\phi$ 0,5mm

W7- $\phi$ 1mm

W5- $\phi$ 1,5mm

W6- $\phi$ 1,5mm

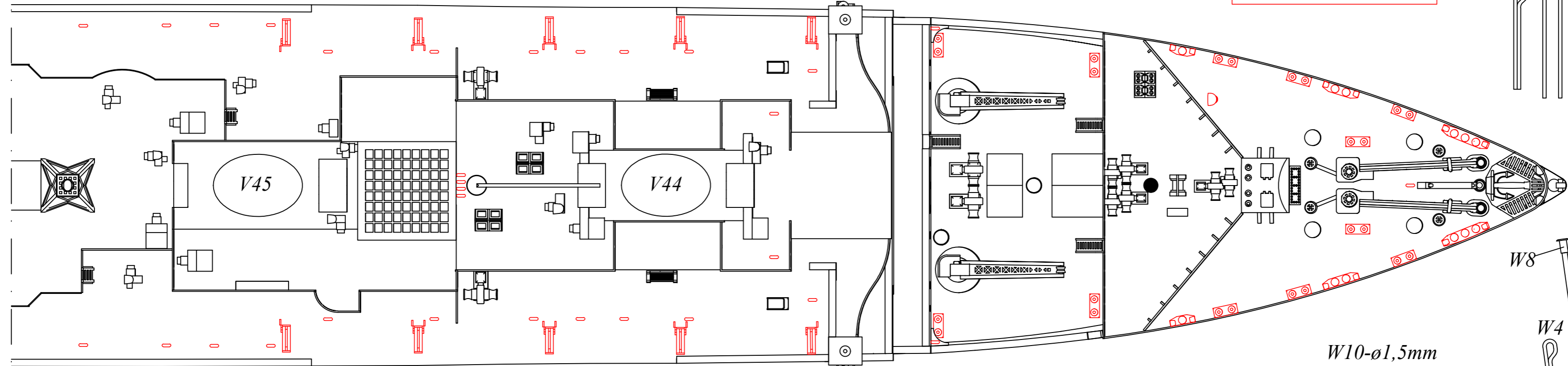
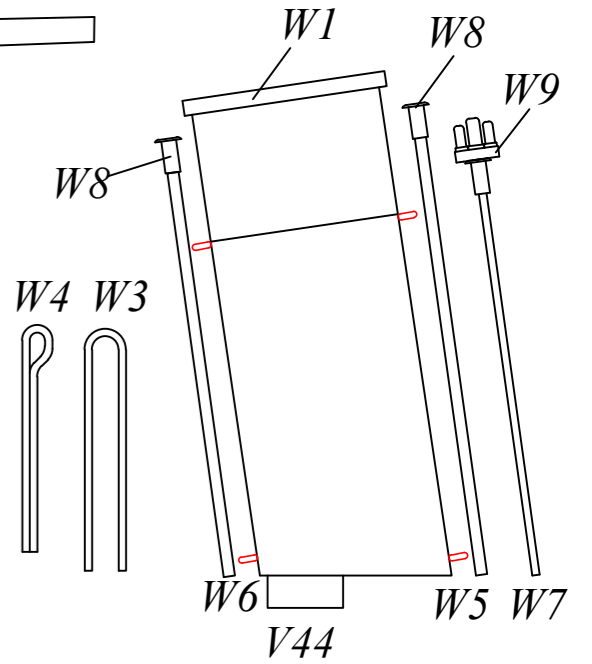

W10- $\phi$ 1,5mm

W11- $\phi$ 1,5mm

W12 - $\phi$ 1mm

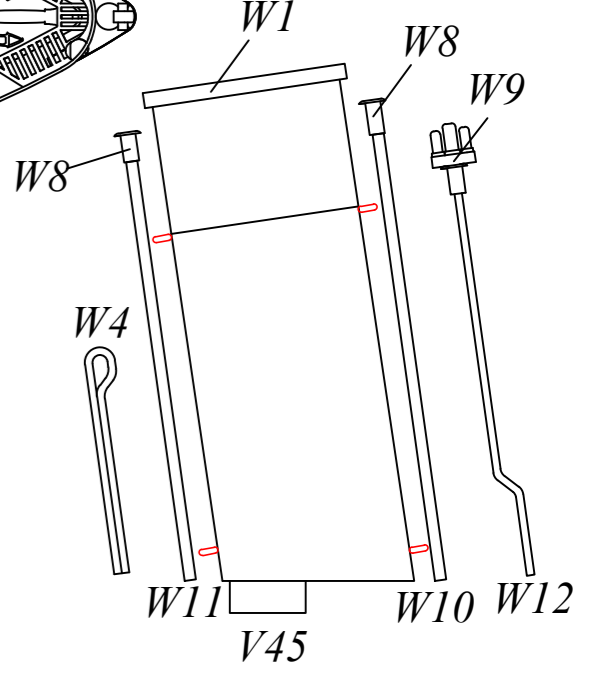

Z60

Z59

Z58

